



Where Automation Connects.



MVI69-GSC
CompactLogix or
MicroLogix Platform
Generic ASCII Serial
Communication Module

October 27, 2020

USER MANUAL

Your Feedback Please

We always want you to feel that you made the right decision to use our products. If you have suggestions, comments, compliments or complaints about our products, documentation, or support, please write or call us.

How to Contact Us

ProSoft Technology, Inc.
+1 (661) 716-5100
+1 (661) 716-5101 (Fax)
www.prosoft-technology.com
support@prosoft-technology.com

Copyright © 2020 ProSoft Technology, Inc. All rights reserved.

MVI69-GSC User Manual

October 27, 2020

ProSoft Technology[®], ProLinx[®], inRAX[®], ProTalk[®], and RadioLinx[®] are Registered Trademarks of ProSoft Technology, Inc. All other brand or product names are or may be trademarks of, and are used to identify products and services of, their respective owners.



For professional users in the European Union

If you wish to discard electrical and electronic equipment (EEE), please contact your dealer or supplier for further information.



Prop 65 Warning – Cancer and Reproductive Harm – www.P65Warnings.ca.gov

Important Installation Instructions

Power, Input, and Output (I/O) wiring must be in accordance with Class I, Division 2 wiring methods, Article 501-4 (b) of the National Electrical Code, NFPA 70 for installation in the U.S., or as specified in Section 18-1J2 of the Canadian Electrical Code for installations in Canada, and in accordance with the authority having jurisdiction. The following warnings must be heeded:

- A** WARNING - EXPLOSION HAZARD - SUBSTITUTION OF COMPONENTS MAY IMPAIR SUITABILITY FOR CLASS I, DIV. 2;
- B** WARNING - EXPLOSION HAZARD - WHEN IN HAZARDOUS LOCATIONS, TURN OFF POWER BEFORE REPLACING OR WIRING MODULES
- C** WARNING - EXPLOSION HAZARD - DO NOT DISCONNECT EQUIPMENT UNLESS POWER HAS BEEN SWITCHED OFF OR THE AREA IS KNOWN TO BE NON-HAZARDOUS.
- D** THIS DEVICE SHALL BE POWERED BY CLASS 2 OUTPUTS ONLY.

MVI (Multi Vendor Interface) Modules

WARNING - EXPLOSION HAZARD - DO NOT DISCONNECT EQUIPMENT UNLESS POWER HAS BEEN SWITCHED OFF OR THE AREA IS KNOWN TO BE NON-HAZARDOUS.

AVERTISSEMENT - RISQUE D'EXPLOSION - AVANT DE DÉCONNECTER L'ÉQUIPEMENT, COUPER LE COURANT OU S'ASSURER QUE L'EMPLACEMENT EST DÉSIGNÉ NON DANGEREUX.

Warnings

North America Warnings

- A** Warning - Explosion Hazard - Substitution of components may impair suitability for Class I, Division 2.
- B** Warning - Explosion Hazard - When in hazardous locations, turn off power before replacing or rewiring modules.
Warning - Explosion Hazard - Do not disconnect equipment unless power has been switched off or the area is known to be non-hazardous.
- C** Suitable for use in Class I, Division 2 Groups A, B, C and D Hazardous Locations or Non-Hazardous Locations.

ATEX Warnings and Conditions of Safe Usage

Power, Input, and Output (I/O) wiring must be in accordance with the authority having jurisdiction.

- A** Warning - Explosion Hazard - When in hazardous locations, turn off power before replacing or wiring modules.
- B** Warning - Explosion Hazard - Do not disconnect equipment unless power has been switched off or the area is known to be non-hazardous.
- C** These products are intended to be mounted in an IP54 enclosure. The devices shall provide external means to prevent the rated voltage being exceeded by transient disturbances of more than 40%. This device must be used only with ATEX certified backplanes.
- D** DO NOT OPEN WHEN ENERGIZED.

Warning: This module is not hot-swappable! Always remove power from the rack before inserting or removing this module, or damage may result to the module, the processor, or other connected devices.

Battery Life Advisory

The MVI46, MVI56, MVI56E, MVI69, and MVI71 modules use a rechargeable Lithium Vanadium Pentoxide battery to backup the real-time clock and CMOS. The battery should last for the life of the module. The module must be powered for approximately twenty hours before the battery becomes fully charged. After it is fully charged, the battery provides backup power for the CMOS setup and the real-time clock for approximately 21 days. When the battery is fully discharged, the module will revert to the default BIOS and clock settings.

Note: The battery is not user replaceable.

Markings

Electrical Ratings

- Backplane Current Load: 800 mA @ 5.1 Vdc
- Power Supply Distance Rating: 2
- Operating Temperature: 0°C to 60°C (32°F to 140°F)
- Storage Temperature: -40°C to 85°C (-40°F to 185°F)
- Relative Humidity: 5% to 95% (without condensation)
- All phase conductor sizes must be at least 1.3 mm² and all earth ground conductors must be at least 4mm².

Agency Approvals & Certifications

Please visit our website: www.prosoft-technology.com

Contents

Your Feedback Please	2
How to Contact Us	2
Important Installation Instructions	3
MVI (Multi Vendor Interface) Modules	3
Warnings	3
Battery Life Advisory	4
Markings.....	4
1 Start Here	7
1.1 System Requirements	8
1.2 Package Contents	9
1.3 Installing ProSoft Configuration Builder Software	10
1.4 Setting Jumpers	10
1.5 Install the Module in the Rack	11
2 Configuring the MVI69-GSC Module	14
2.1 MVI69-GSC Sample Add-On Instruction Import Procedure.....	15
2.1.1 Create a new RSLogix5000 project	15
2.1.2 Create the Module.....	16
2.1.3 Import the Ladder Rung	19
2.1.4 Adding Multiple Modules (Optional)	22
2.2 Connecting Your PC to the Processor	28
2.3 Downloading the Sample Program to the Processor	29
2.3.1 Configuring the RSLinx Driver for the PC COM Port	30
2.4 Connect your PC to the Module	32
2.5 Using ProSoft Configuration Builder	33
2.5.1 Setting Up the Project	33
2.5.2 Renaming PCB Objects	35
2.6 Configuration Data	37
2.7 Changing Parameters During Operation.....	41
2.8 Downloading the Project to the Module Using a Serial COM port	42
3 Ladder Logic	43
3.1 Adding the Module to an Existing CompactLogix Project	44
3.2 Adding the Module to an Existing MicroLogix Project	47
4 Diagnostics and Troubleshooting	49
4.1 LED Status Indicators.....	50
4.1.1 Clearing a Fault Condition.....	51
4.1.2 Troubleshooting.....	52
4.2 Using ProSoft Configuration Builder (PCB) for Diagnostics.....	53
4.2.1 Using the Diagnostic Window in ProSoft Configuration Builder.....	53
4.2.2 Navigation	55
4.2.3 Main Menu.....	56

4.2.4	Data Analyzer	58
4.3	Reading Status Data from the Module	60
5	Reference	61
<hr/>		
5.1	Product Specifications	62
5.1.1	General Specifications	62
5.1.2	Hardware Specifications.....	63
5.1.3	Functional Specifications.....	64
5.2	Functional Overview	65
5.2.1	General Concepts	65
5.2.2	Data Flow between MVI69-GSC Module and CompactLogix Processor.....	66
5.2.3	Special Function Blocks	71
5.3	Cable Connections	72
5.3.1	RS-232 Configuration/Debug Port	72
5.3.2	RS-232 Application Port(s).....	72
5.3.3	RS-422	75
5.3.4	RS-485 Application Port(s).....	75
5.3.5	DB9 to RJ45 Adaptor (Cable 14)	76
5.4	GSC Database Definition	77
5.5	Status Data Definition.....	78
6	Support, Service & Warranty	81
<hr/>		
6.1	Contacting Technical Support	81
6.2	Warranty Information	81
Index		82
<hr/>		

1 Start Here

In This Chapter

❖ System Requirements	8
❖ Package Contents	9
❖ Installing ProSoft Configuration Builder Software	10
❖ Setting Jumpers.....	10
❖ Install the Module in the Rack.....	11

To get the most benefit from this User Manual, you should have the following skills:

- **Rockwell Automation® RSLogix™ software:** launch the program, configure ladder logic, and transfer the ladder logic to the processor
- **Microsoft Windows:** install and launch programs, execute menu commands, navigate dialog boxes, and enter data
- **Hardware installation and wiring:** install the module, and safely connect and CompactLogix or MicroLogix devices to a power source and to the MVI69-GSC module's application port(s)

1.1 System Requirements

The MVI69-GSC module requires the following minimum hardware and software components:

- Supports all *Rockwell Automation CompactLogix* and *MicroLogix* processors except 1769-L23E-QBFC1B, 1769-L16x, and 1769-L18x. Requires compatible power supply and one free slot in the rack, for the MVI69-GSC module. The module requires 800 mA of available power.

Important: The MVI69-GSC module has a power supply distance rating of 2 (L43 and L45 installations on first 2 slots of 1769 bus).

- *Rockwell Automation RSLogix 5000 (CompactLogix)* or *RSLogix 500 (MicroLogix)* programming software
- *Rockwell Automation RSLinx* communication software
- *Pentium® II* 450 MHz minimum. *Pentium III* 733 MHz (or better) recommended
- Supported operating systems:
 - Microsoft Windows 10
 - Microsoft Windows 7 Professional (32-or 64-bit)
 - Microsoft Windows XP Professional with Service Pack 1 or 2
 - Microsoft Windows Vista
 - Microsoft Windows 2000 Professional with Service Pack 1, 2, or 3
 - Microsoft Windows Server 2003
- 128 Mbytes of RAM minimum, 256 Mbytes of RAM recommended
- 100 Mbytes of free hard disk space (or more based on application requirements)
- 256-color VGA graphics adapter, 800 x 600 minimum resolution (True Color 1024 × 768 recommended)
- HyperTerminal or other terminal emulator program capable of file transfers using Ymodem protocol.

1.2 Package Contents

The following components are included with your MVI69-GSC module, and are all required for installation and configuration.

Important: Before beginning the installation, please verify that all of the following items are present.

Qty.	Part Name	Part Number	Part Description
1	MVI69-GSC Module	MVI69-GSC	Generic ASCII Serial Communication Module
1	Cable	Cable #15, RS232 Null Modem	For RS232 Connection to the CFG Port
3	Cable	Cable #14, RJ45 to DB9 Male Adapter cable	For DB9 Connection to Module's Port
2	Adapter	1454-9F	Two Adapters, DB9 Female to Screw Terminal. For RS422 or RS485 Connections to Port 1 and 2 of the Module

If any of these components are missing, please contact ProSoft Technology Support for replacement parts.

1.3 Installing ProSoft Configuration Builder Software

You must install the *ProSoft Configuration Builder (PCB)* software to configure the module. You can always get the newest version of *ProSoft Configuration Builder* from the ProSoft Technology website.

Installing ProSoft Configuration Builder from the ProSoft website

- 1 Open your web browser and navigate to <http://www.prosoft-technology.com/pcb>
- 2 Click the **DOWNLOAD HERE** link to download the latest version of *ProSoft Configuration Builder*.
- 3 Choose **SAVE** or **SAVE FILE** when prompted.
- 4 Save the file to your *Windows Desktop*, so that you can find it easily when you have finished downloading.
- 5 When the download is complete, locate and open the file, and then follow the instructions on your screen to install the program.

1.4 Setting Jumpers

When the module is manufactured, the port selection jumpers are set to RS-232. To use RS-422 or RS-485, you must set the jumpers to the correct position. The following diagram describes the jumper settings.

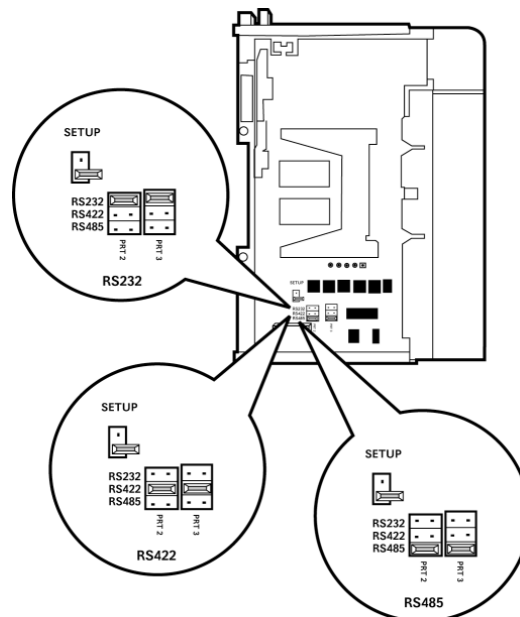

The Setup Jumper acts as "write protection" for the module's flash memory. In "write protected" mode, the Setup pins are not connected, and the module's firmware cannot be overwritten. Do not jumper the Setup pins together unless you are directed to do so by ProSoft Technical Support.

1.5 Install the Module in the Rack

This section describes how to install the module into a CompactLogix or MicroLogix rack. Before you attempt to install the module, make sure that the bus lever of the adjacent module is in the unlocked (fully right) position.

Warning: This module is not hot-swappable! Always remove power from the rack before inserting or removing this module, or damage may result to the module, the processor, or other connected devices.

- 1 Align the module using the upper and lower tongue-and-groove slots with the adjacent module and slide forward in the direction of the arrow.

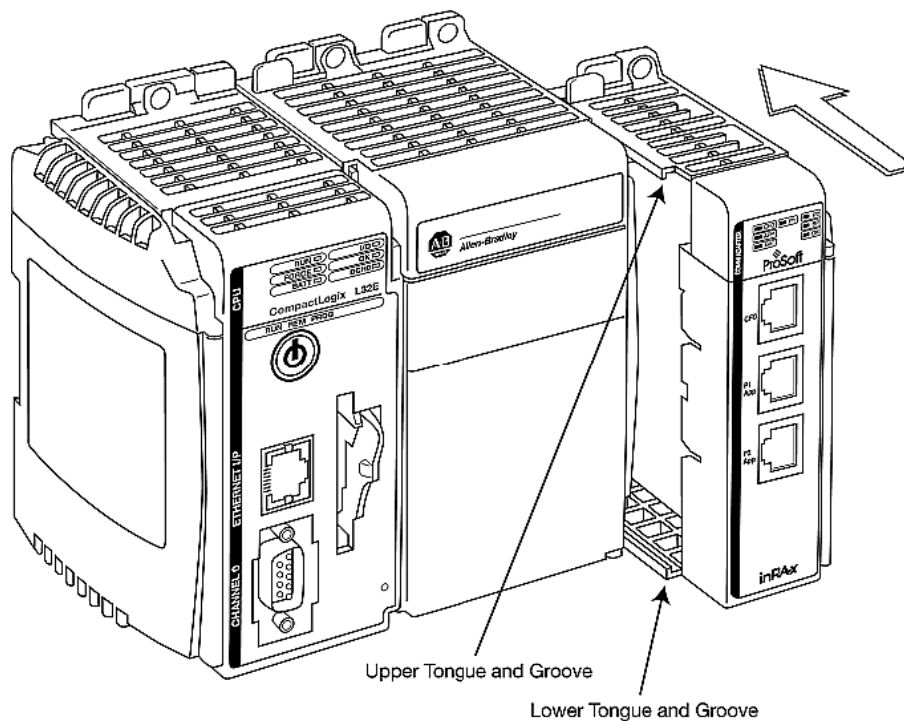

- 2 Move the module back along the tongue-and-groove slots until the bus connectors on the MVI69 module and the adjacent module line up with each other.

- 3 Push the module's bus lever back slightly to clear the positioning tab and move it firmly to the left until it clicks. Ensure that it is locked firmly in place.

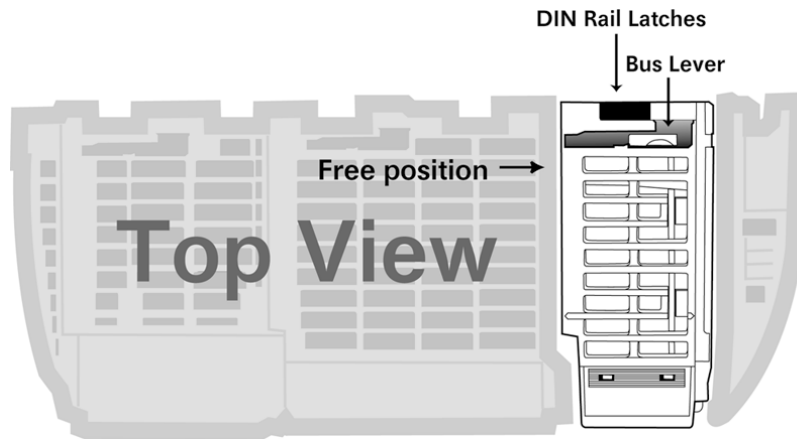

Move the Bus Lever to the left
until it clicks

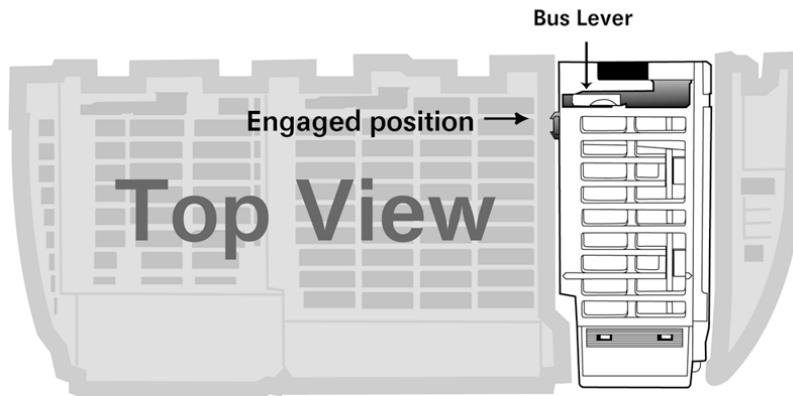

- 4 Close all DIN-rail latches.

- 5 Press the DIN-rail mounting area of the controller against the DIN-rail. The latches will momentarily open and lock into place.

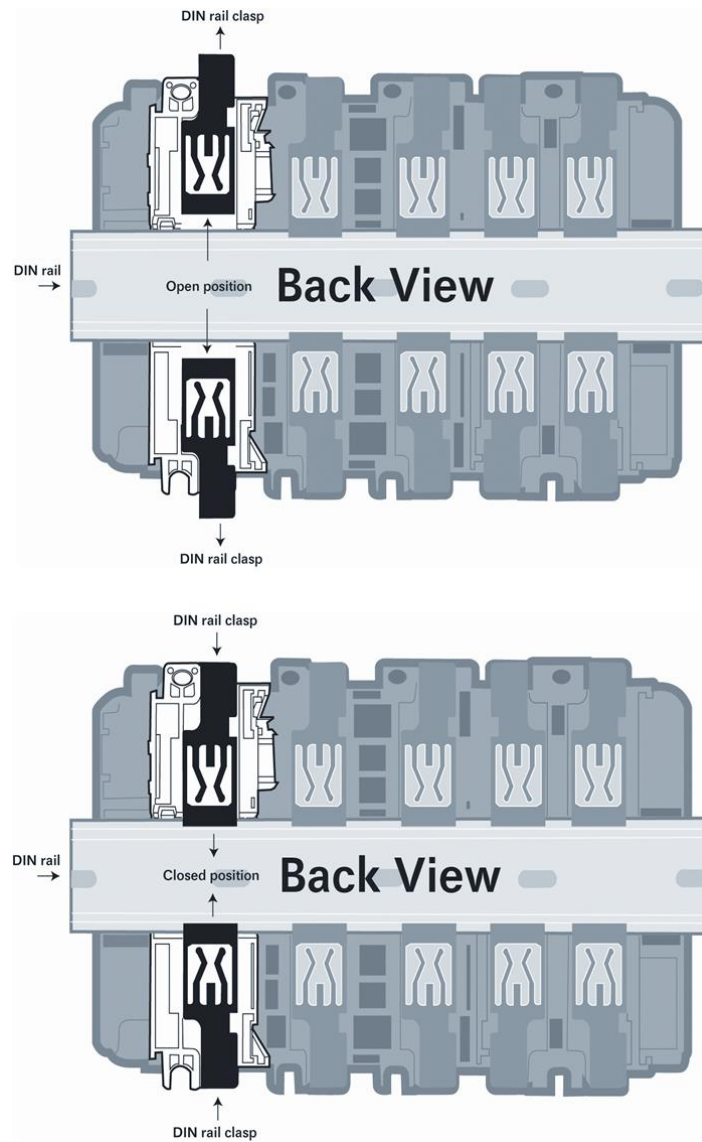

2 Configuring the MVI69-GSC Module

In This Chapter

- ❖ MVI69-GSC Sample Add-On Instruction Import Procedure 15
- ❖ Connecting Your PC to the Processor 28
- ❖ Downloading the Sample Program to the Processor 29
- ❖ Connect your PC to the Module 32
- ❖ Using ProSoft Configuration Builder 33
- ❖ Configuration Data 37
- ❖ Changing Parameters During Operation 41
- ❖ Downloading the Project to the Module Using a Serial COM port 42

2.1 MVI69-GSC Sample Add-On Instruction Import Procedure

Note: this section only applies if you are using RSLogix 5000 version 16 or higher. If you are configuring the MVI69-GSC module with an earlier version of RSLogix 5000, please refer to 69GSC - Installing and Configuring the Module with a CompactLogix Processor (page 44).

The following file is required before you start this procedure. You can download it from www.prosoft-technology.com.

File Name	Description
AOI69GSC.L5X	L5X file containing Add-On instruction, user defined data types, data objects and ladder logic required to set up the MVI69-GSC module

2.1.1 Create a new RSLogix5000 project

- 1 Open the **FILE** menu, and then choose **NEW...**

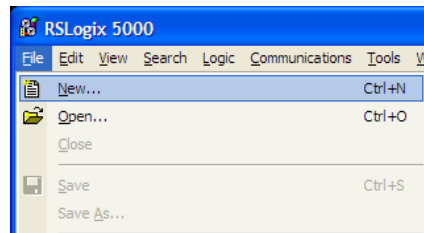

- 2 Select **REVISION 16**

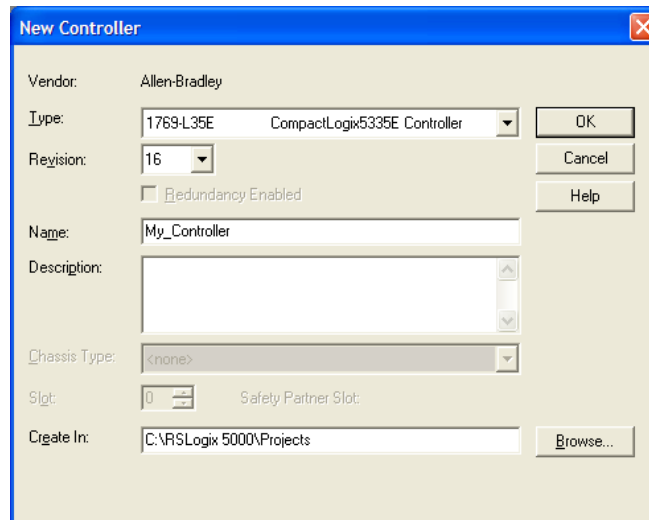

2.1.2 Create the Module

- 1 Right-click I/O Configuration and choose New Module...

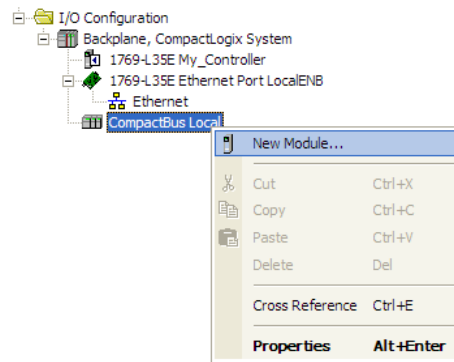

- 2 Select 1769-MODULE

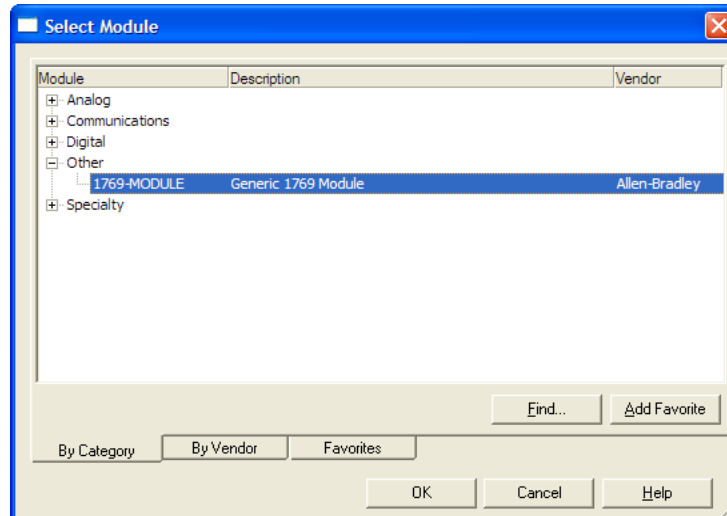

3 Set the Module Properties values as follows:

Parameter	Value
Name	Enter a module identification string. Example: MVI69GSC
Description	Enter a description for the module. Example: ProSoft communication module for ModbusTCP/IP communication.
Comm Format	Select DATA-INT
Slot	Enter the slot number in the rack where the MVI69-GSC module will be installed.
Input Assembly Instance	101
Input Size	60
Output Assembly Instance	100
Output Size	60
Configuration Assembly Instance	102
Configuration Size	0

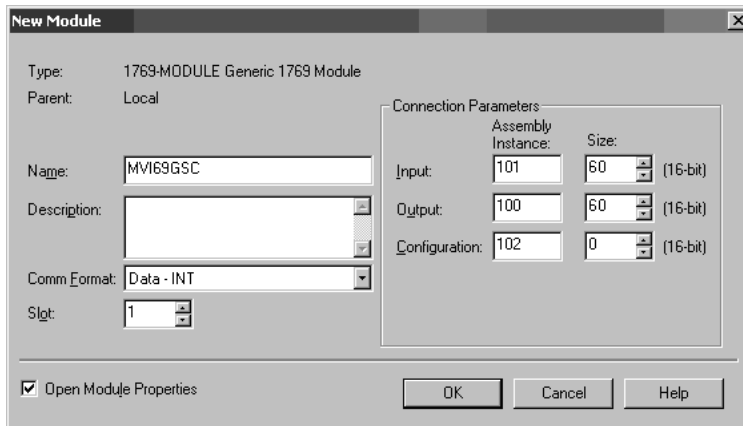

- 4 On the Connection tab, set the RPI value for your project. Click OK to confirm.

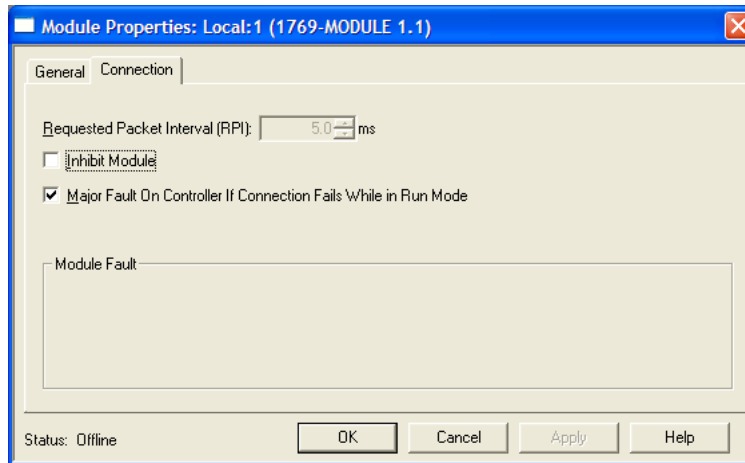

Now the MVI69-GSC module will be visible at the I/O Configuration section.

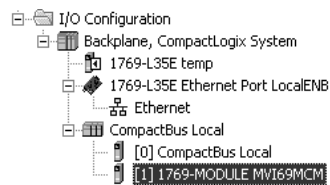

2.1.3 Import the Ladder Rung

- 1 Open your application in RSLogix 5000.
- 2 Expand the Tasks folder, and then expand the Main Task folder.
- 3 On the Main Program folder, click the right mouse button to open a shortcut menu. On the shortcut menu, choose New Routine.
- 4 In the New Routine dialog box, enter the name and description of your routine, and then click OK.
- 5 Select an empty rung in the new routine, and then click the right mouse button to open a shortcut menu. On the shortcut menu, choose "Import Rung...".

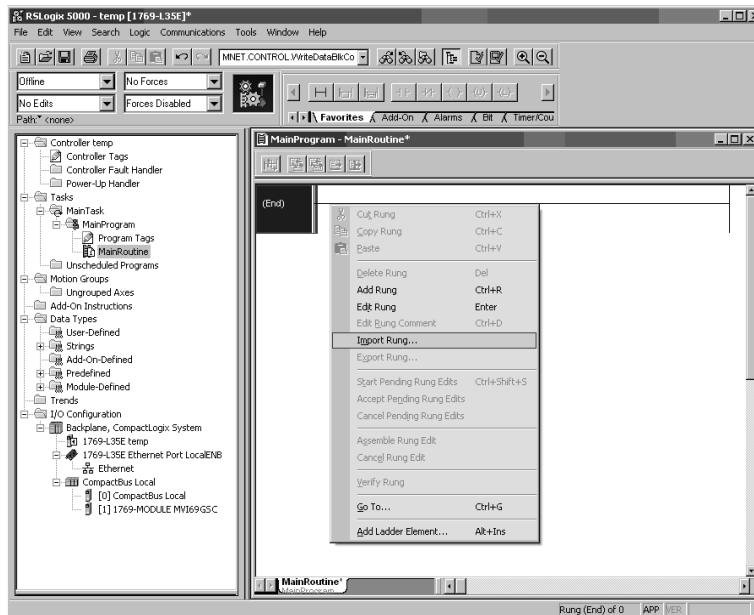

- 6 Select the AOI69GSC.L5X file. The Add-On Instruction file is at: www.prosoft-technology.com.

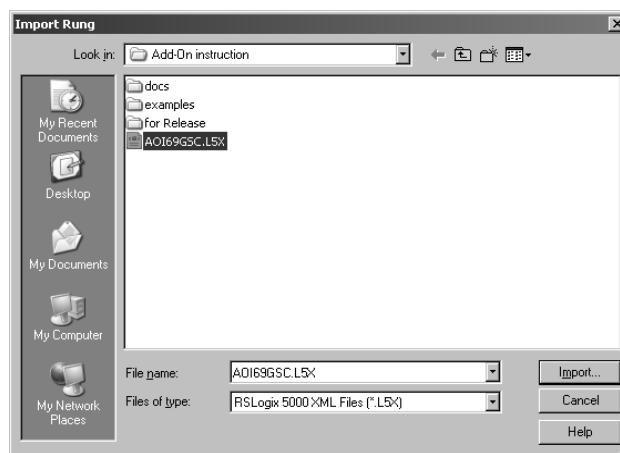

- 7 The following window will be displayed showing the controller tags to be created during the import procedure:

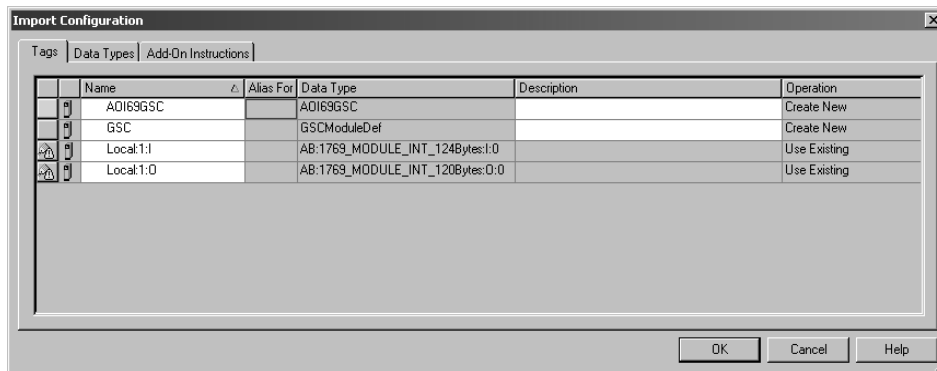

- 8 If you are using the module in a different slot (or remote rack) select the correct connection input and output variables associated to the module. If your module is located in slot 1 of the local rack this step is not required.

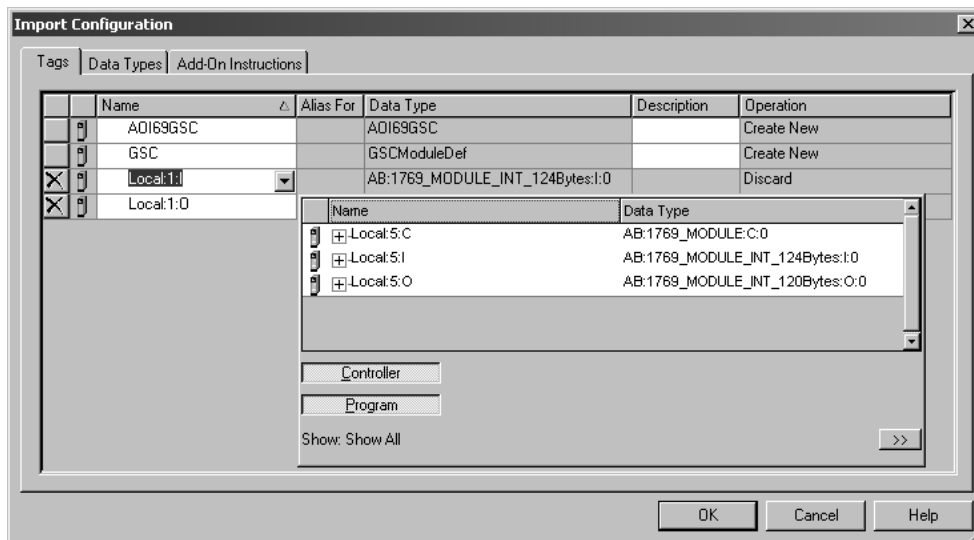

- Click OK to confirm the import. RSLogix will indicate that the import is under progress:

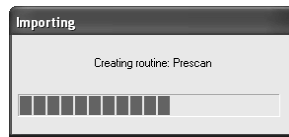

When the import is completed, the new rung with the Add-On instruction will be visible as shown in the following illustration.

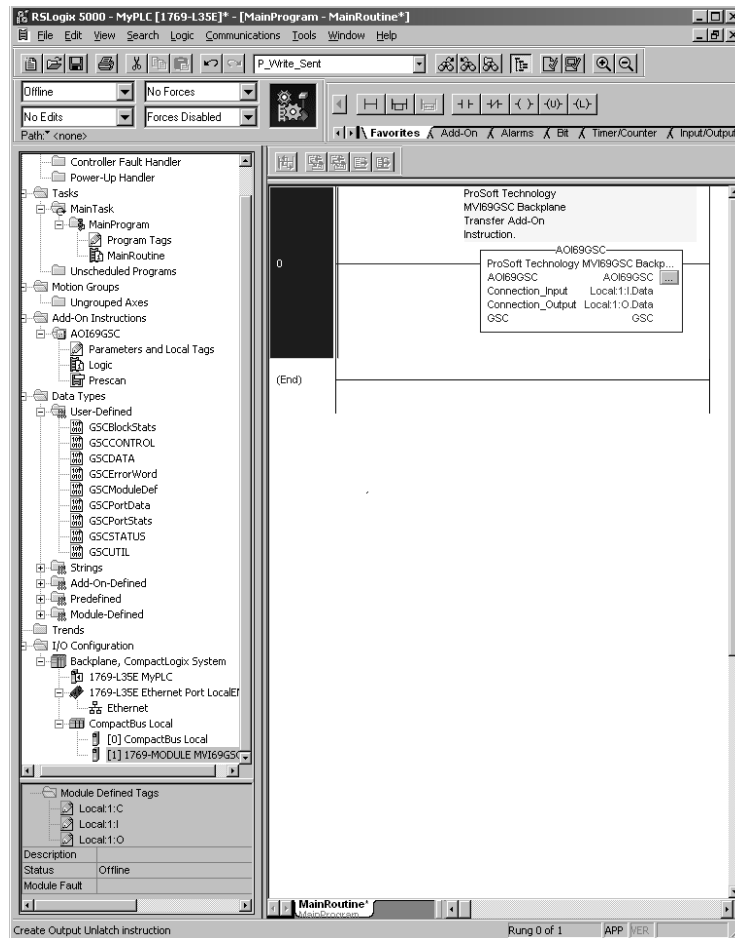

The procedure has also imported new user defined data types, data objects and the Add-On instruction to be used at your project.



Save the application and proceed to download the ladder logic into the processor.

2.1.4 Adding Multiple Modules (Optional)

Important: If your application requires more than one MVI69-GSC module in the same project, follow the steps below.

- 1 In the I/O Configuration folder, click the right mouse button to open a shortcut menu, and then choose New Module.

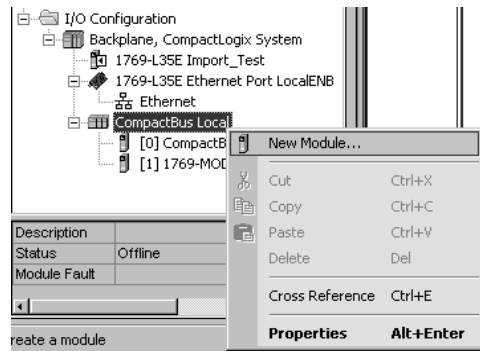

- 2 Select 1769-MODULE

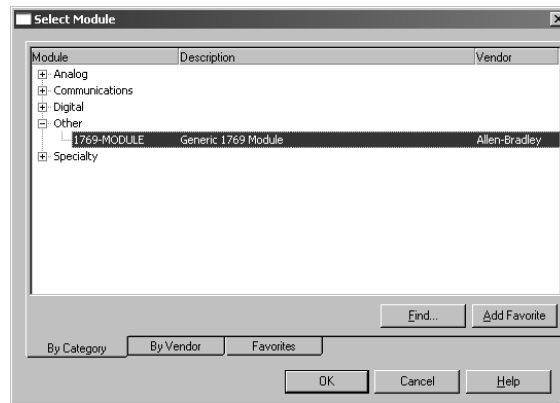

- 3 Fill the module properties as follows:

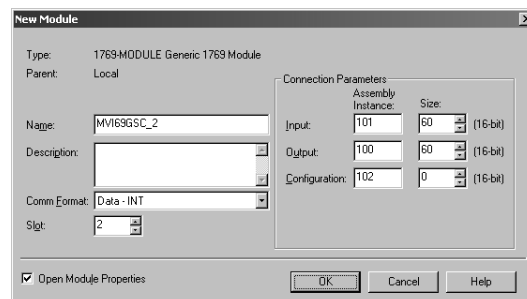

Parameter	Value
Name	Enter a module identification string. Example: MVI69MCM_2
Description	Enter a description for the module. Example: ProSoft communication module for Serial Modbus communications.
Comm Format	Select Data-INT
Slot	Enter the slot number in the rack where the MV69-MCM module will be installed.
Input Assembly Instance	101
Input Size	60
Output Assembly Instance	100
Output Size	60
Configuration Assembly Instance	102
Configuration Size	0

4 Click OK to confirm. The new module is now visible:

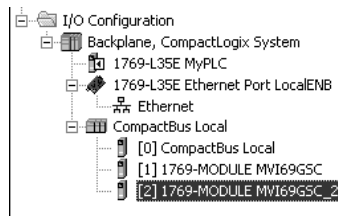

- 5 Expand the Tasks folder, and then expand the MainTask folder.
- 6 On the MainProgram folder, click the right mouse button to open a shortcut menu. On the shortcut menu, choose New Routine.
- 7 In the New Routine dialog box, enter the name and description of your routine, and then click OK.

- 8 Select an empty rung in the new routine, and then click the right mouse button to open a shortcut menu. On the shortcut menu, choose "Import Rung...".

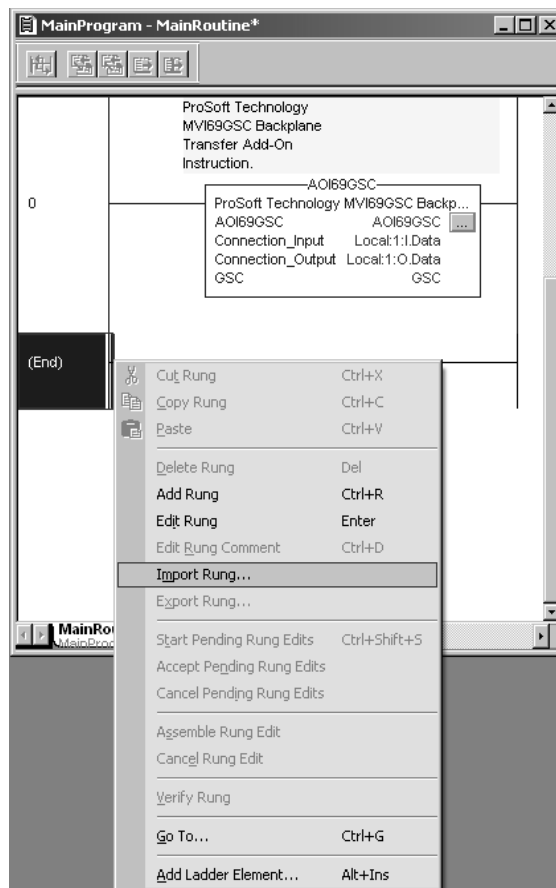

- 9 Select the *AOI69GSC.L5X* file. The Add-On Instruction file is located at www.prosoft-technology.com.

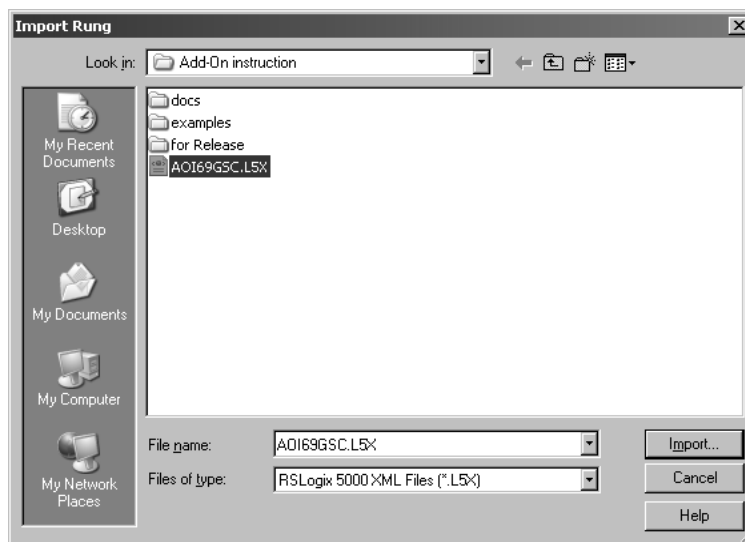

10 The following window will be displayed showing the tags to be imported:

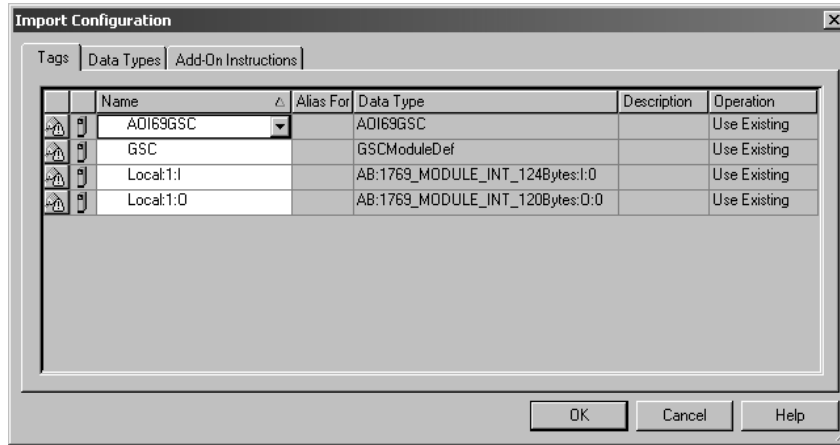

11 Associate the I/O connection variables to the correct module. The default values are Local:1:I and Local:1:O so these require change.

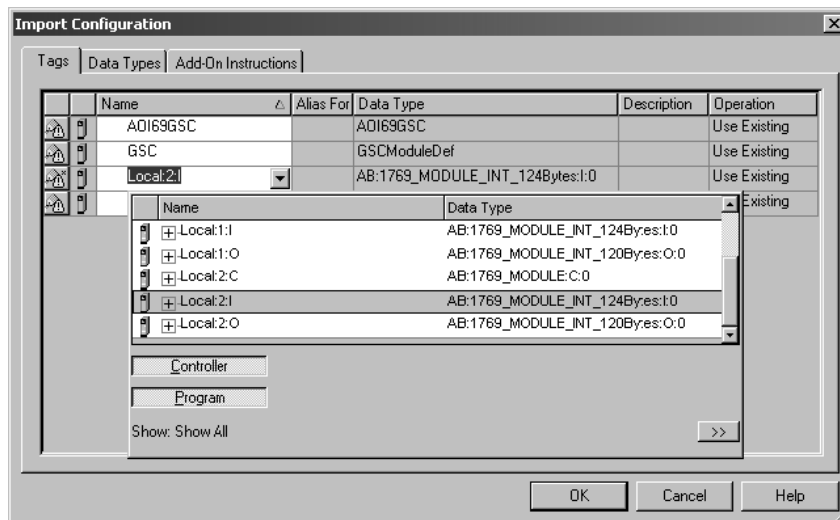

- 12** Change the default tags GSC and AOI69GSC to avoid conflict with existing tags.
This procedure will append the string "_2" as follows:

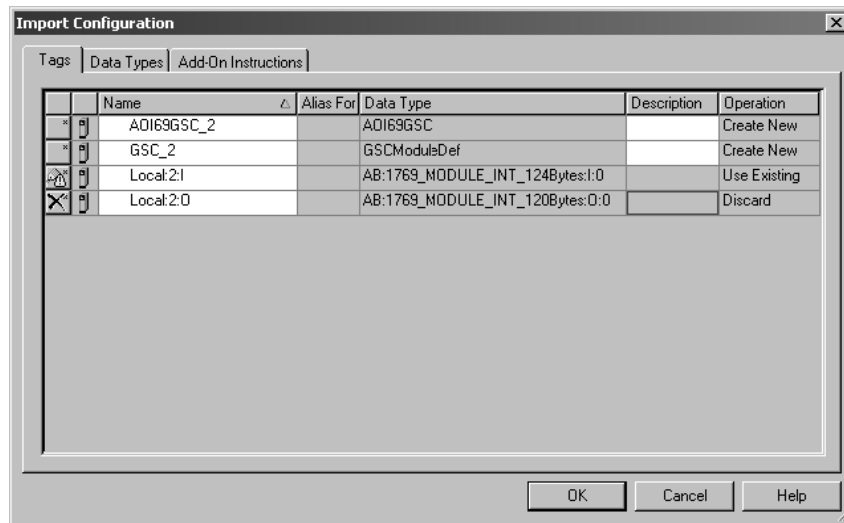

13 Click OK to confirm.

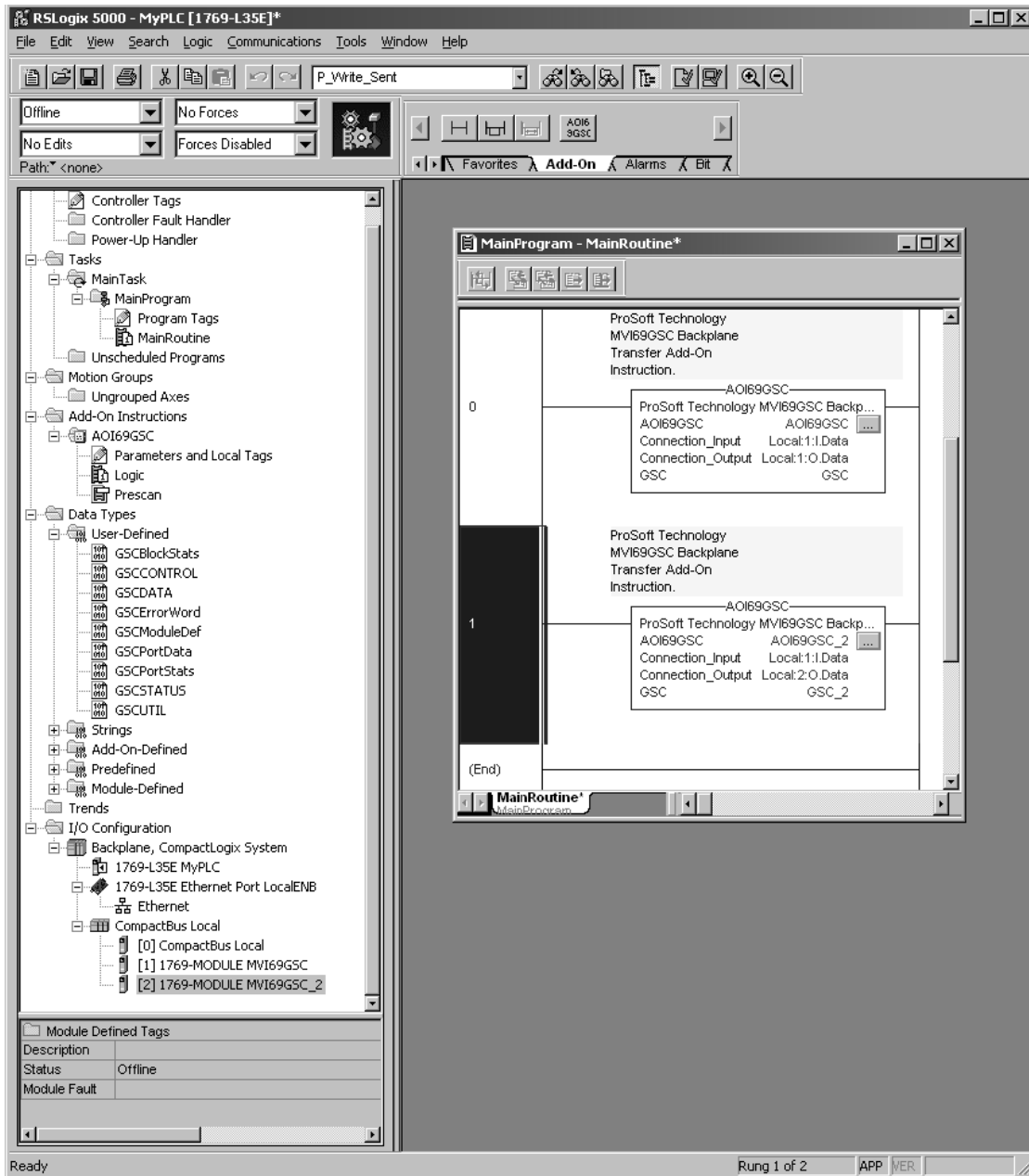

The setup procedure is now complete. Save the project and download the application to your ControlLogix processor.

2.2 Connecting Your PC to the Processor

- 1 Connect the right-angle connector end of the cable to your controller at the communications port.

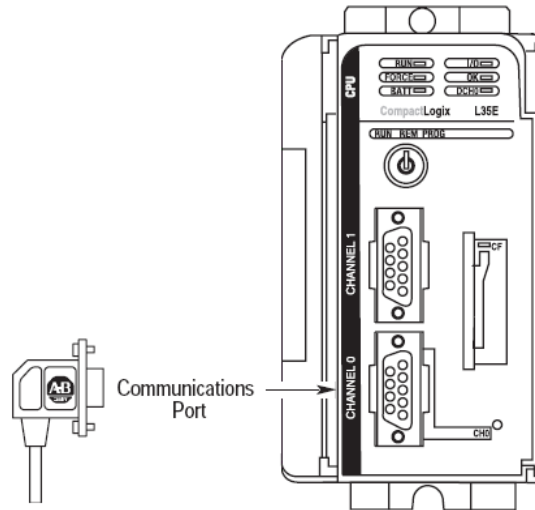

- 2 Connect the straight connector end of the cable to the serial port on your computer.

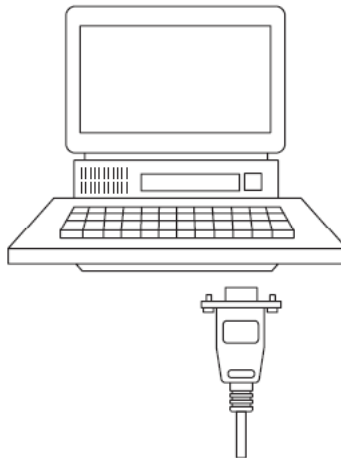

2.3 Downloading the Sample Program to the Processor

Note: The key switch on the front of the *CompactLogix* processor must be in the REM or PROG position.

- 1 If you are not already online to the processor, open the **COMMUNICATIONS** menu, and then choose **DOWNLOAD**. *RSLogix* will establish communication with the processor.
- 2 When communication is established, *RSLogix* will open a confirmation dialog box. Click the **DOWNLOAD** button to transfer the sample program to the processor.

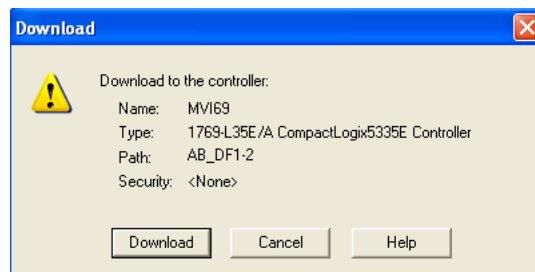

- 3 *RSLogix* will compile the program and transfer it to the processor. This process may take a few minutes.
- 4 When the download is complete, *RSLogix* will open another confirmation dialog box. Click **OK** to switch the processor from PROGRAM mode to RUN mode.

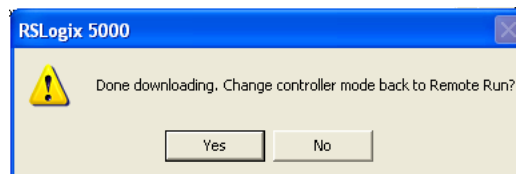

Note: If you receive an error message during these steps, refer to your *RSLogix* documentation to interpret and correct the error.

2.3.1 Configuring the RSLinx Driver for the PC COM Port

If RSLogix is unable to establish communication with the processor, follow these steps.

- 1 Open *RSLinx*.
- 2 Open the **COMMUNICATIONS** menu, and choose **CONFIGURE DRIVERS**.

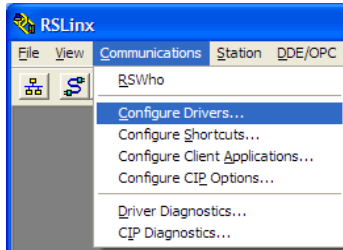

This action opens the *Configure Drivers* dialog box.

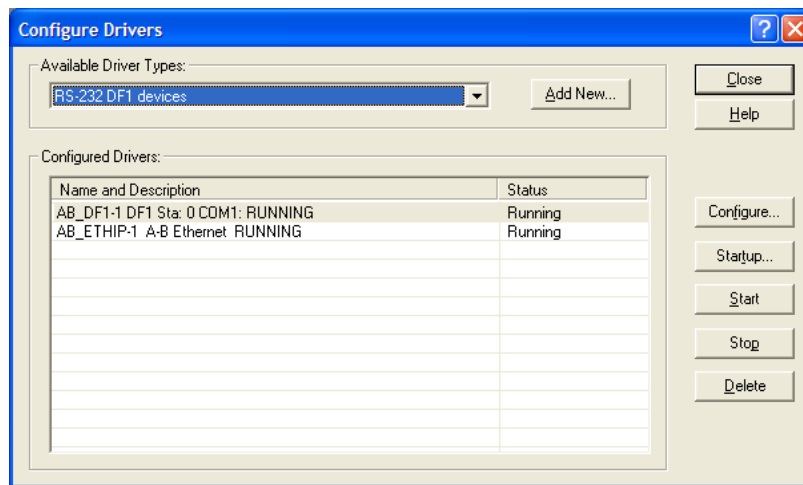

Note: If the list of configured drivers is blank, you must first choose and configure a driver from the Available Driver Types list. The recommended driver type to choose for serial communication with the processor is *RS-232 DF1 Devices*.

- 1 Click to select the driver, and then click **CONFIGURE**. This action opens the *Configure RS-232 DF1 Devices* dialog box.

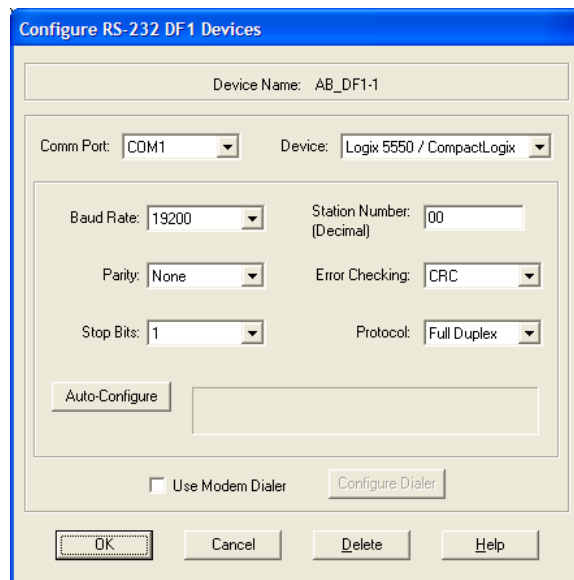

- 2 Click the **AUTO-CONFIGURE** button. *RSLinx* will attempt to configure your serial port to work with the selected driver.
- 3 When you see the message *Auto Configuration Successful*, click the **OK** button to dismiss the dialog box.

Note: If the auto-configuration procedure fails, verify that the cables are connected correctly between the processor and the serial port on your computer, and then try again. If you are still unable to auto-configure the port, refer to your *RSLinx* documentation for further troubleshooting steps.

2.4 Connect your PC to the Module

With the module securely mounted, connect your PC to the Configuration/Debug port using an RJ45-DB-9 Serial Adapter Cable and a Null Modem Cable.

- 1 Attach both cables as shown.
- 2 Insert the RJ45 cable connector into the Configuration/Debug port of the module.
- 3 Attach the other end to the serial port on your PC.

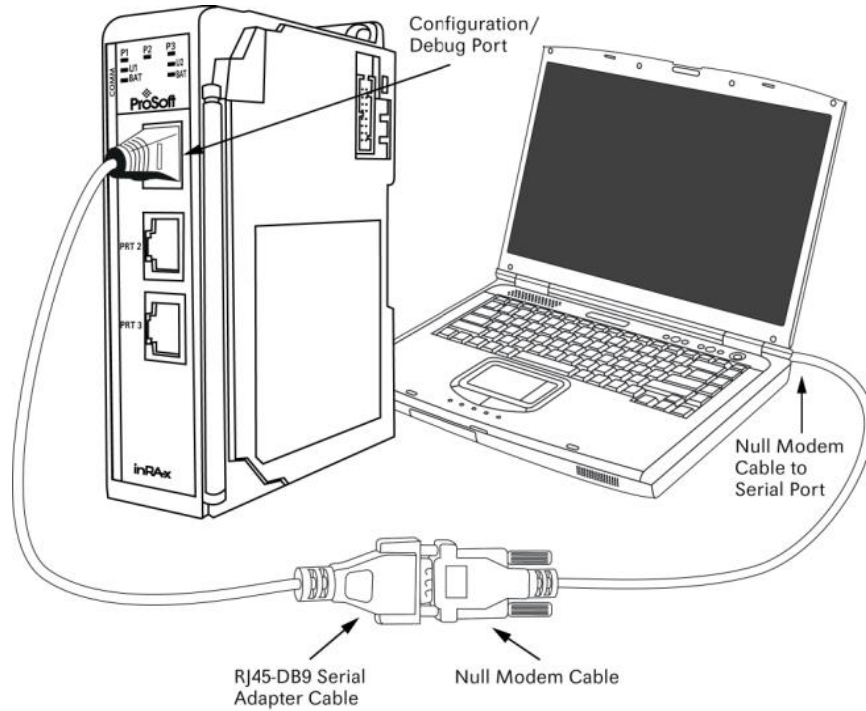

2.5 Using ProSoft Configuration Builder

ProSoft Configuration Builder (PCB) provides a quick and easy way to manage module configuration files customized to meet your application needs. *PCB* is not only a powerful solution for new configuration files, but also allows you to import information from previously installed (known working) configurations to new projects.

2.5.1 Setting Up the Project

To begin, start *ProSoft Configuration Builder*. If you have used other *Windows* configuration tools before, you will find the screen layout familiar. *ProSoft Configuration Builder's* window consists of a tree view on the left, an information pane and a configuration pane on the right side of the window. When you first start *ProSoft Configuration Builder*, the tree view consists of folders for *Default Project* and *Default Location*, with a *Default Module* in the *Default Location* folder. The following illustration shows the *ProSoft Configuration Builder* window with a new project.

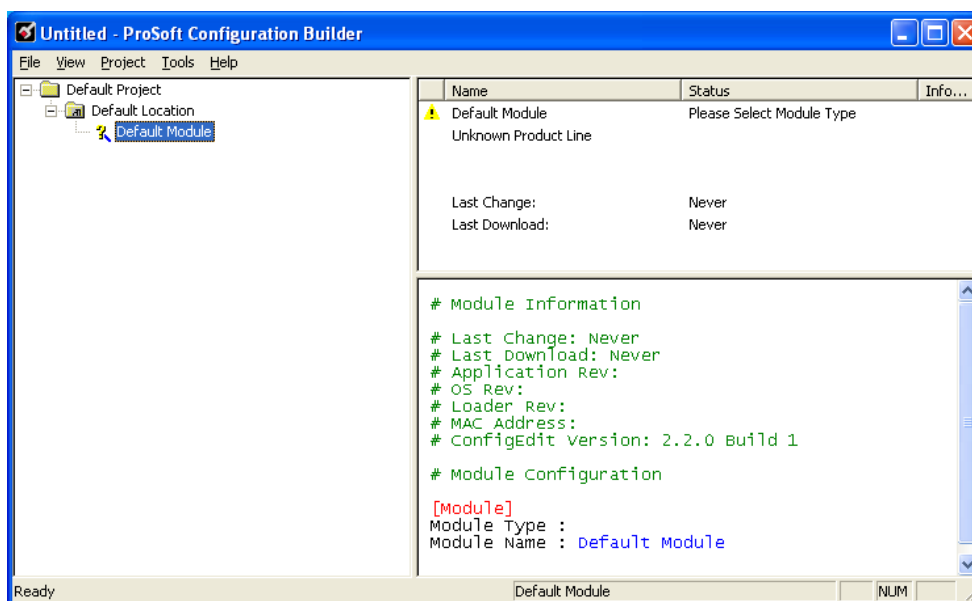

Your first task is to add the MVI69-GSC module to the project.

- 1 Use the mouse to select **DEFAULT MODULE** in the tree view, and then click the right mouse button to open a shortcut menu.

- 2 On the shortcut menu, select **CHOOSE MODULE TYPE**. This action opens the *Choose Module Type* dialog box.

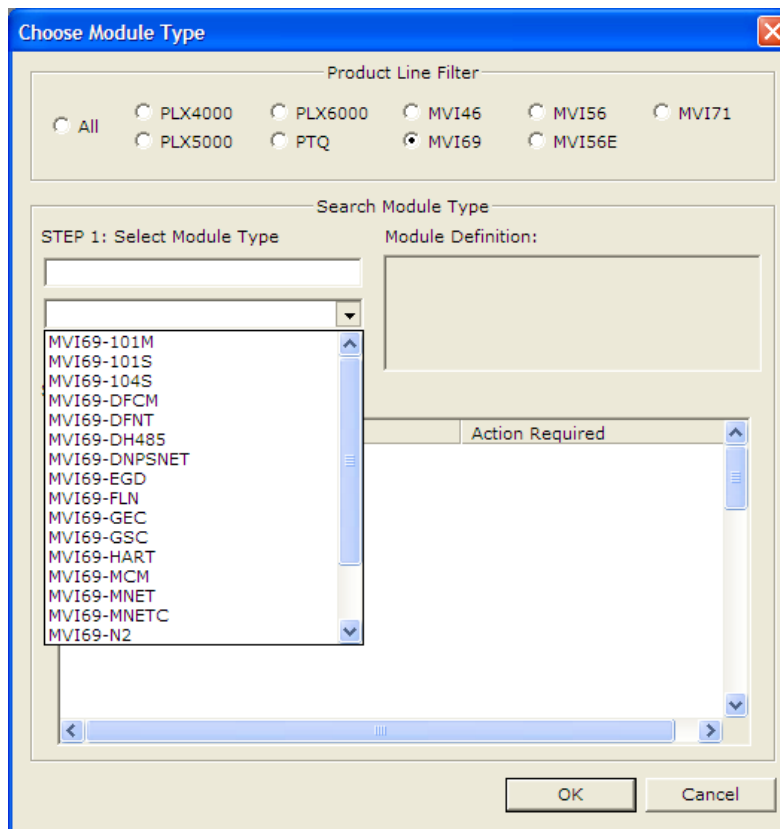

- 3 In the *Product Line Filter* area of the dialog box, select **MVI69**. In the *Select Module Type* dropdown list, select **MVI69-GSC**, and then click **OK** to save your settings and return to the *ProSoft Configuration Builder* window.

2.5.2 Renaming PCB Objects

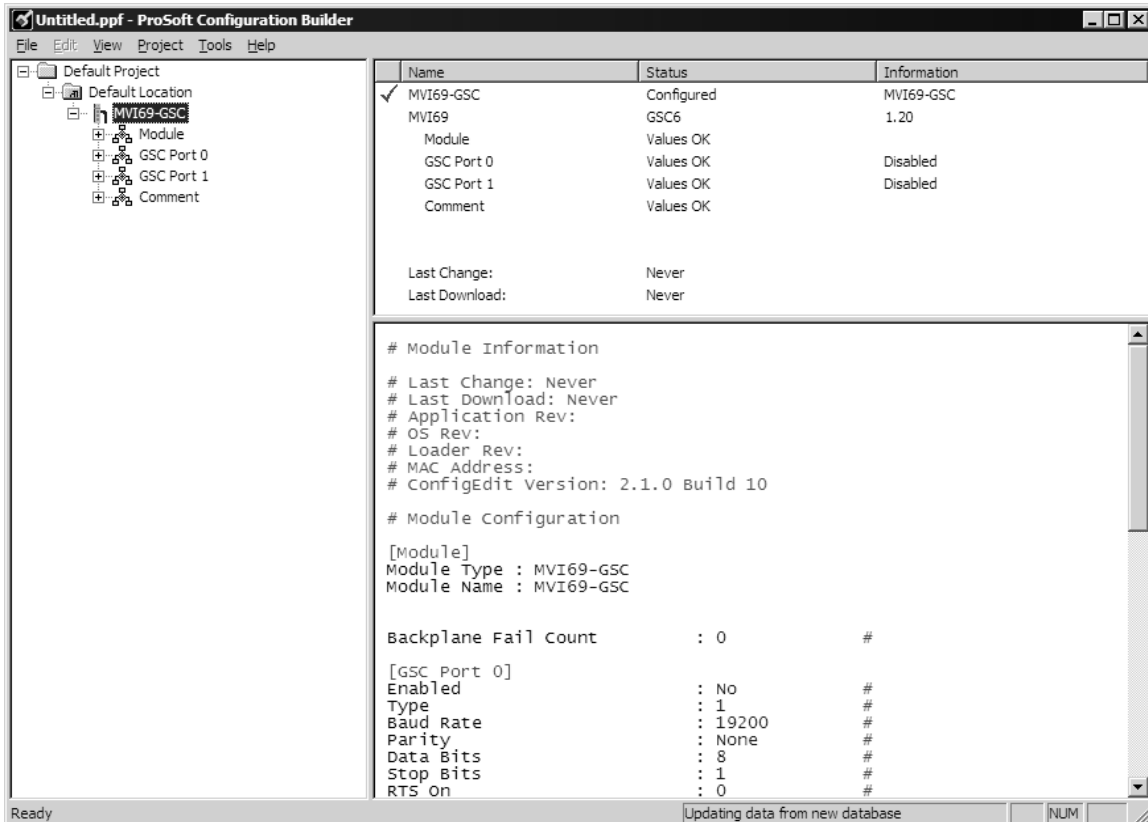

Notice that the contents of the information pane and the configuration pane changed when you added the module to the project.



At this time, you may wish to rename the *Default Project* and *Default Location* folders in the tree view.

- 1 Select the object, and then click the right mouse button to open a shortcut menu. From the shortcut menu, choose **RENAME**.
- 2 Type the name to assign to the object.
- 3 Click away from the object to save the new name.

Configuring Module Parameters

- 1 Click on the **[+]** sign next to the module icon to expand module information.
- 2 Click on the **[+]** sign next to any  icon to view module information and configuration options.
- 3 Double-click any  icon to open an *Edit* dialog box.
- 4 To edit a parameter, select the parameter in the left pane and make your changes in the right pane.
- 5 Click **OK** to save your changes.

Printing a Configuration File

- 1 Select the module icon, and then click the right mouse button to open a shortcut menu.
- 2 On the shortcut menu, choose **VIEW CONFIGURATION**. This action opens the *View Configuration* window.
- 3 In the *View Configuration* window, open the **FILE** menu, and choose **PRINT**. This action opens the *Print* dialog box.
- 4 In the *Print* dialog box, choose the printer to use from the drop-down list, select printing options, and then click **OK**.

2.6 Configuration Data

This section contains listings of the MVI69-GSC module's database that are related to the module's configuration. This data is available to any node on the network and is read from the CompactLogix processor when the module first initializes. Additionally, this section contains the miscellaneous status data and command control database layout.

[Section]/Item	Value	Range	Description
[MODULE]			Module section header
Module Name:		0 to 80 characters	This parameter assigns a name to the module that can be viewed using the configuration/debug port. Use this parameter to identify the module and the configuration file.
Backplane Fail Count:		0 to 65535	This parameter specifies the number of successive transfer errors that must occur before the communication ports are shut down. If the parameter is set to zero, the communication ports will continue to operate under all conditions. If the value is set larger than 0 (1 to 65535), communications will cease if the specified number of failures occur.

[Section]/Item	Value	Range	Description
[GSC Port 0]			GSC port definition header
Enabled:		Yes or No	This parameter defines if this port will be utilized. If the parameter is set to No, the port is disabled. A value of Yes will enable the port.
Type:		0 to 15	This parameter specifies the receive termination characteristics for the port. This value is bit mapped as follows: Bit 0 = Termination character(s) used, Bit1=Message timeout used, Bit2=Intercharacter delay timeout used and Bit3=Packet size limit used. If the parameter is set to zero, the port is placed in stream mode.
Baud Rate:		From selected list of codes	This is the baud rate to be used on the port. Enter the baud rate as a value. For example, to select 19K baud, enter 19200. Valid entries for this field include: 110, 150, 300, 600, 1200, 2400, 4800, 9600, 19200, 384 or 3840 for 38400, 576 or 5760 for 57600 and 115 or 1150 for 115200.
Parity:		None, Even, Odd, Mark or Space	This is the Parity code to be used for the port. The values are as follows: None, Odd, Even, Mark and Space.
Data Bits:		5 to 8	This parameter sets the number of data bits for each word used by the protocol. Valid entries for this field are 5, 6, 7 and 8.
Stop Bits:		1 or 2	This parameter sets the number of stop bits to be used with each data value sent. Valid entries for this field are 1 and 2.

[Section]/Item	Value	Range	Description
RTS On:		0 to 65535	This parameter sets the number of milliseconds to delay after RTS is asserted before the data will be transmitted. Valid values are in the range of 0 to 65535.
RTS Off:		0 to 65535	This parameter sets the number of milliseconds to delay after the last byte of data is sent before the RTS modem signal will be set low. Valid values are in the range of 0 to 65535.
Handshaking:	NONE, RTS/CTS, DTR/DSR or XON/XOFF		This parameter specifies the handshaking used on the port. The values are as follows: None=No hardware or software handshaking, RTS/CTS hardware handshaking, DTR/DSR hardware handshaking and XON/XOFF software handshaking.
Rx Term Char Count:		0 to 12	This parameter is used if bit 0 of the Type parameter is set. This value (0 to 12) defines the number of termination characters used to define the end of received message.
Rx Term Characters:	List of up to 12 integer values		This array of 12 integer values representing the characters used to define the termination characters at the end of each received message. The number of characters to be used in the array is set in the RTermCnt parameter.
Rx Packet Length:		0 to 4096	This parameter is used if bit 3 is set in the Type parameter. The parameter sets the length of data required to be received on the port before transferring the data to the processor.
Rx Message Timeout:		0 to 65535	This parameter is used if bit 1 is set in the Type parameter. The parameter sets the number of milliseconds to wait after the first character is received on the port before automatically sending the data to the processor.
Rx Intercharacter Delay:		0 to 65535	This parameter is used if bit 2 is set in the Type parameter. The parameter sets the number of milliseconds to wait between each character received on the port before sending the data to the processor.
Rx Swap Bytes:	Yes or No		This parameter specifies if the data received should have its bytes swapped before sending over the backplane.
Tx Message Timeout:		0 to 65535	This parameter specifies the timeout period to transmit a message out the port. A message must be transmitted out the port within the specified timeout period. Message transmission will be aborted if the timeout is exceeded.
Tx Minimum Delay:		0 to 65535	This parameter specifies the minimum number of milliseconds to delay before transmitting a message out the port. This pre-send delay is applied before the RTS on time. This may be required when communicating with slow devices.

[Section]/Item	Value	Range	Description
Tx Swap Bytes:		Yes or No	This parameter specifies if the data to be transmitted out the port will have the bytes swapped from the data presented across the backplane.
<hr/>			
[Section]/Item	Value	Range	Description
[GSC Port 1]			GSC port definition header
Enabled:		Yes or No	This parameter defines if this port will be utilized. If the parameter is set to No, the port is disabled. A value of Yes will enable the port.
Type:		0 to 15	This parameter specifies the receive termination characteristics for the port. This value is bit mapped as follows: Bit 0 = Termination character(s) used, Bit1=Message timeout used, Bit2=Intercharacter delay timeout used and Bit3=Packet size limit used. If the parameter is set to zero, the port is placed in stream mode.
Baud Rate:		From selected list of codes	This is the baud rate to be used on the port. Enter the baud rate as a value. For example, to select 19K baud, enter 19200. Valid entries for this field include: 110, 150, 300, 600, 1200, 2400, 4800, 9600, 19200, 384 or 3840 for 38400, 576 or 5760 for 57600 and 115 or 1150 for 115200.
Data Bits:		5 to 8	This parameter sets the number of data bits for each word used by the protocol. Valid entries for this field are 5, 6, 7 and 8.
Stop Bits:		1 or 2	This parameter sets the number of stop bits to be used with each data value sent. Valid entries for this field are 1 and 2.
RTS On:		0 to 65535	This parameter sets the number of milliseconds to delay after RTS is asserted before the data will be transmitted. Valid values are in the range of 0 to 65535.
RTS Off:		0 to 65535	This parameter sets the number of milliseconds to delay after the last byte of data is sent before the RTS modem signal will be set low. Valid values are in the range of 0 to 65535.
Handshaking:		NONE, RTS/CTS, DTR/DSR or XON/XOFF	This parameter specifies the handshaking used on the port. The values are as follows: None=No hardware or software handshaking, RTS/CTS hardware handshaking, DTR/DSR hardware handshaking and XON/XOFF software handshaking.
Rx Term Char Count:		0 to 12	This parameter is used if bit 0 of the Type parameter is set. This value (0 to 12) defines the number of termination characters used to define the end of received message.
Rx Term Characters:		List of up to 12 integer values	This array of 12 integer values representing the characters used to define the termination characters at the end of each received message. The number of characters to be used in the array is set in the RTermCnt parameter.

[Section]/Item	Value	Range	Description
Rx Packet Length:		0 to 4096	This parameter is used if bit 3 is set in the Type parameter. The parameter sets the length of data required to be received on the port before transferring the data to the processor.
Rx Message Timeout:		0 to 65535	This parameter is used if bit 1 is set in the Type parameter. The parameter sets the number of milliseconds to wait after the first character is received on the port before automatically sending the data to the processor.
Rx Intercharacter Delay:		0 to 65535	This parameter is used if bit 2 is set in the Type parameter. The parameter sets the number of milliseconds to wait between each character received on the port before sending the data to the processor.
Rx Swap Bytes:		Yes or No	This parameter specifies if the data received should have its bytes swapped before sending over the backplane.
Tx Message Timeout:		0 to 65535	This parameter specifies the timeout period to transmit a message out the port. A message must be transmitted out the port within the specified timeout period. Message transmission will be aborted if the timeout is exceeded.
Tx Minimum Delay:		0 to 65535	This parameter specifies the minimum number of milliseconds to delay before transmitting a message out the port. This pre-send delay is applied before the RTS on time. This may be required when communicating with slow devices.
Tx Swap Bytes:		Yes or No	This parameter specifies if the data to be transmitted out the port will have the bytes swapped from the data presented across the backplane.

2.7 Changing Parameters During Operation

A copy of the module's configuration data is mapped in the module's database as described in the following table. These values are initialized when the module first receives its configuration from the configuration file.

The configuration file is located in the module as well as website. With a new module, ProSoft recommends that you download the configuration file from the module for editing. Refer to the next topic for information on transferring the configuration file.

Function	Name	Description
Data Transfer	General Module Configuration	This section of the configuration data contains the module configuration data that defines the data transfer between the module and the CompactLogix processor.
Serial Port Drivers	Port Configuration	These sections define the characteristics of each of the Generic ASCII Serial communication ports on the module. These parameters must be sent correctly for proper module operation.

2.8 Downloading the Project to the Module Using a Serial COM port

For the module to use the settings you configured, you must download (copy) the updated *Project* file from your PC to the module.

- 1 In the tree view in *ProSoft Configuration Builder*, click once to select the module.
- 2 Open the *Project* menu, and then choose **MODULE/DOWNLOAD**. The program will scan your PC for a valid com port (this may take a few seconds). When *PCB* has found a valid COM port, the *Download* dialog box will open.

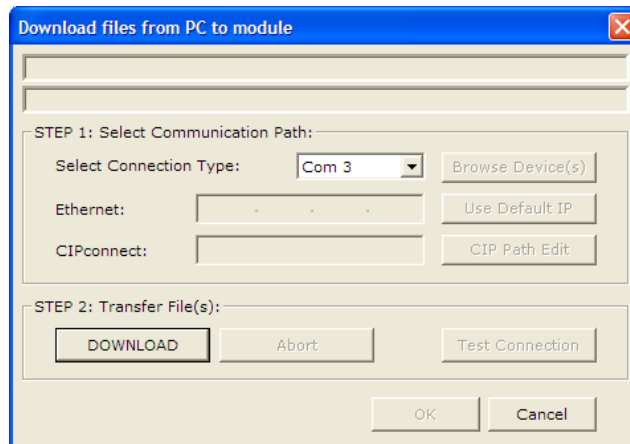

- 3 Choose the COM port to use from the dropdown list, and then click the **DOWNLOAD** button.

The module will perform a platform check to read and load its new settings. When the platform check is complete, the status bar in the *Download* dialog box will display the message *Module Running*.

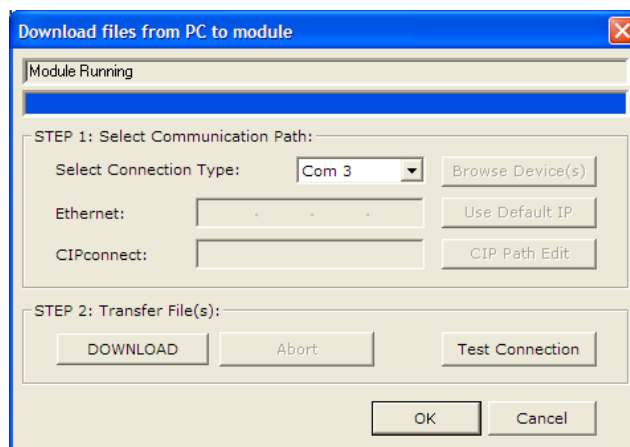

3 Ladder Logic

In This Chapter

- ❖ Adding the Module to an Existing CompactLogix Project44
- ❖ Adding the Module to an Existing MicroLogix Project47
- ❖ Adjust the Input and Output Array Sizes (Optional)49

Ladder logic is required for application of the MVI69-GSC module. Tasks that must be handled by the ladder logic are module data transfer, special block handling, and status data receipt. Additionally, a power-up handler may be needed to handle the initialization of the module's data and to clear any processor fault conditions.

The sample ladder logic is extensively commented, to provide information on the purpose and function of each rung. For most applications, the sample ladder will work without modification.

3.1 Adding the Module to an Existing CompactLogix Project

Important: The following steps describe how to install and configure the MVI69-GSC module with RSLogix 5000 version 15 or older. If you are using RSLogix 5000 version 16, please refer to Sample Add-On Instruction Import Procedure (page 15).

Important: The MVI69-GSC module has a power supply distance rating of 2 (L43 and L45 installations on first 2 slots of 1769 bus)

If you are installing and configuring the module with a CompactLogix processor, follow these steps. If you are using a MicroLogix processor, refer to the next section.

- 1 Add the MVI69-GSC module to the project.** Right-click the mouse button on the I/O Configuration option in the Controller Organization window to display a pop-up menu. Select the New Module option from the I/O Configuration menu.

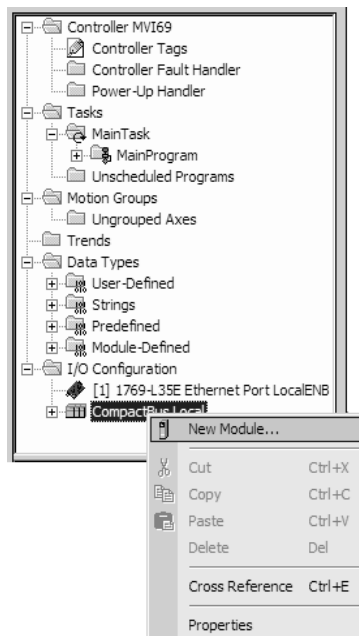

This action opens the following dialog box:

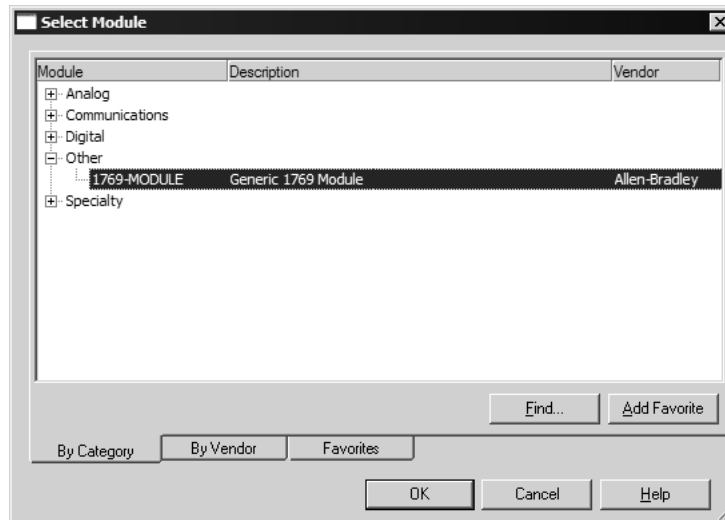

- 2 Select the 1769-Module (Generic 1769 Module) from the list and click OK.

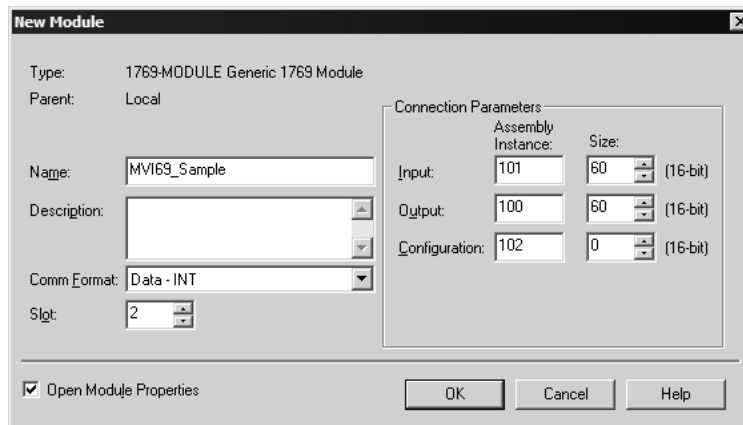

- 3 Enter the Name, Description and Slot options for your application, using the values in the illustration above. You must select the **Comm Format** as **Data - INT** in the dialog box, otherwise the module will not communicate over the backplane of the CompactLogix rack.

Click **OK** to continue.

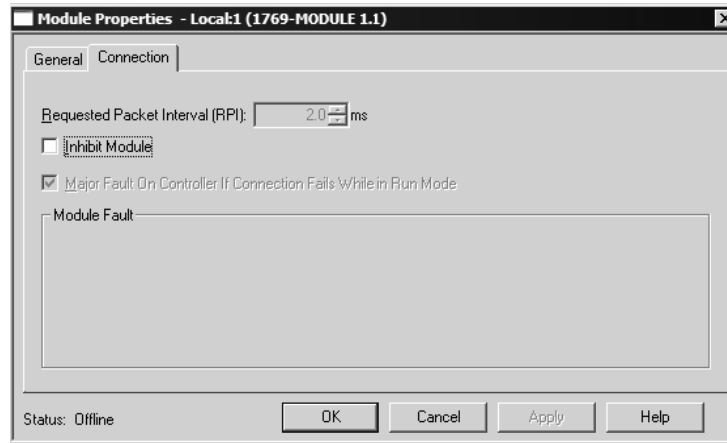

- 4 Select the Request Packet Interval value for scanning the I/O on the module. This value represents the minimum frequency the module will handle scheduled events. This value should not be set to less than 1 millisecond. Values between 1 and 10 milliseconds should work with most applications.
- 5 Save the module. Click OK to dismiss the dialog box. The Controller Organization window now displays the module's presence. The following illustration shows the Controller Organization window:

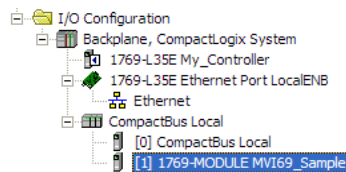

- 6 Copy the Controller Tags from the sample program.
- 7 Copy the User Defined Data Types from the sample program.
- 8 Copy the Ladder Rungs from the sample program.
- 9 Save and Download (page 29) the new application to the controller and place the processor in run mode.

3.2 Adding the Module to an Existing MicroLogix Project

If you are installing and configuring the module with a MicroLogix processor, follow these steps. If you are using a CompactLogix processor, refer to the previous section.

The first step in setting up the processor ladder file is to define the I/O type module to the system. Start RSLogix 500, and follow these steps:

- 1 In RSLogix, open your existing application, or start a new application, depending on your requirements.
- 2 Double-click the I/O Configuration icon located in the Controller folder in the project tree. This action opens the I/O Configuration dialog box.

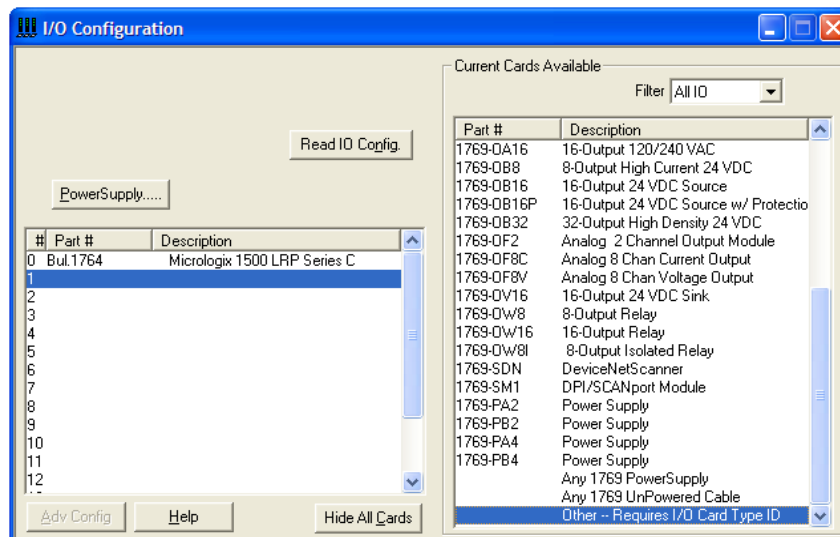

- 3 On the I/O Configuration dialog box, select "Other - Requires I/O Card Type ID" at the bottom of the list in the right pane, and then double-click to open the Module dialog box.
- 4 Enter the values shown in the following illustration to define the module correctly for the MicroLogix processor. Click OK to save your configuration.

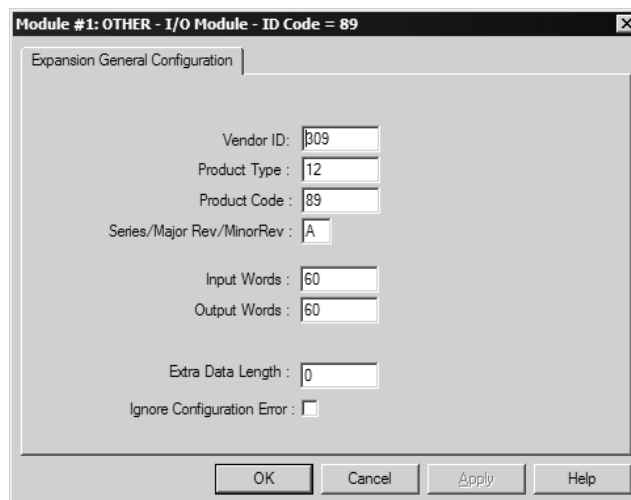

The input words and output words parameter will depend on the Block Transfer Size parameter you specify in the configuration file. Use the values from the following table.

Block Transfer Size	Input Words	Output Words
60	60	60

- 5 Click **Next** to continue.
- 6 After completing the module setup, the I/O configuration dialog box will display the module's presence.

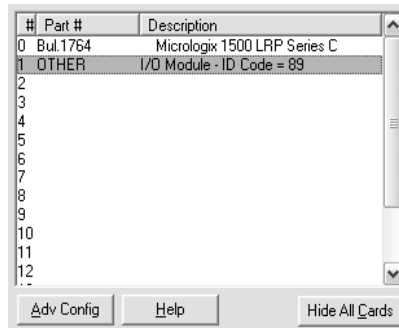

The last step is to add the ladder logic. If you are using the example ladder logic, adjust the ladder to fit your application. Refer to the example Ladder Logic section in this manual.

Download the new application to the controller and place the processor in run mode. If you encounter errors, refer to **Diagnostics and Troubleshooting** (page 49) for information on how to connect to the module's Config/Debug port to use its troubleshooting features.

4 Diagnostics and Troubleshooting

In This Chapter

- ❖ LED Status Indicators50
- ❖ Using ProSoft Configuration Builder (PCB) for Diagnostics53
- ❖ Reading Status Data from the Module60

The module provides information on diagnostics and troubleshooting in the following forms:

- LED status indicators on the front of the module provide general information on the module's status.
- Status data contained in the module can be viewed through the Configuration/Debug port, using the troubleshooting and diagnostic capabilities of *ProSoft Configuration Builder (PCB)*.
- Status data values can be transferred from the module to processor memory and can be monitored there manually or by customer-created logic. For details on Status Data values, see MVI69-GSC Status Data Area.

4.1 LED Status Indicators

The LEDs indicate the module's operating status as follows:

LED	Color	Status	Indication
CFG	Green	On	Data is being transferred between the module and a remote terminal using the Configuration/Debug port.
		Off	No data is being transferred on the Configuration/Debug port.
P1	Green	On	Data is being transferred between the module and the Generic Serial (ASCII) network on Port 1.
		Off	No data is being transferred on the port.
P2	Green	On	Data is being transferred between the module and the Generic Serial (ASCII) network on Port 2.
		Off	No data is being transferred on the port.
APP	Amber	On	The MVI69-GSC module program has recognized a communication error on one of its ports.
		Off	The MVI69-GSC is functioning normally.
BP ACT	Amber	On	The LED is on when the module is performing a write operation on the backplane.
		Off	The LED is off when the module is performing a read operation on the backplane. Under normal operation, the LED should blink rapidly on and off.
OK	Red/ Green	Off	The card is not receiving any power and is not securely plugged into the rack.
		Green	The module is operating normally.
		Red	The program has detected an error or is being configured. If the LED remains red for over 10 seconds, the program has probably halted. Remove the card from the rack and re-insert the card to restart the module's program.
BAT	Red	Off	The battery voltage is OK and functioning.
		On	The battery voltage is low or battery is not present. Allow battery to charge by keeping module plugged into rack for 24 hours. If BAT LED still does not go off, contact ProSoft Technology, as this is not a user serviceable item.

During module configuration, the OK LED will be red and the APP and BP ACT LEDs will be on.

If the APP, BP ACT and OK LEDs blink at a rate of every one-second, this indicates a serious problem with the module. Call ProSoft Technology support to arrange for repairs.

4.1.1 Clearing a Fault Condition

Typically, if the OK LED on the front of the module turns RED for more than ten seconds, a hardware problem has been detected in the module or the program has exited.

To clear the condition, follow these steps:

- 1** Turn off power to the rack.
- 2** Remove the card from the rack.
- 3** Verify that all jumpers are set correctly.
- 4** If the module requires a Compact Flash card, verify that the card is installed correctly.
- 5** Re-insert the card in the rack and turn the power back on.
- 6** Verify correct configuration data is being transferred to the module from the CompactLogix or MicroLogix controller.

If the module's OK LED does not turn GREEN, verify that the module is inserted completely into the rack. If this does not cure the problem, contact ProSoft Technology Technical Support.

4.1.2 Troubleshooting

Use the following troubleshooting steps if you encounter problems when the module is powered up. If these steps do not resolve your problem, please contact ProSoft Technology Technical Support.

Processor Errors

Problem Description	Steps to take
Processor Fault	<p>Verify that the module is plugged into the slot that has been configured for the module.</p> <p>Verify that the slot in the rack configuration has been set up correctly in the ladder logic.</p>
Processor I/O LED flashes	<p>This indicates a problem with backplane communications. Verify that all modules in the rack are configured in the ladder logic.</p> <p>Module has a power supply distance rating of 2 on CompactLogix. The module must be within 2 slots of the power supply on CompactLogix, or that the MicroLogix backplane can supply the 800ma required for the module.</p>

Module Errors

Problem Description	Steps to take
BP ACT LED remains off or blinks slowly	<p>This indicates that backplane transfer operations are failing. Connect to the module's Configuration/Debug port to check this.</p> <p>To establish backplane communications, verify the following items:</p> <ul style="list-style-type: none"> ▪ The processor is in Run mode ▪ The backplane driver is loaded in the module ▪ The module is configured for read and write block data transfer ▪ The ladder logic handles all read and write block situations ▪ The module is configured in the processor
OK LED remains red	<p>The program has halted or a critical error has occurred. Connect to the Configuration/Debug port to see if the module is running. If the program has halted, turn off power to the rack, remove the card from the rack and re-insert the card in the rack, and then restore power to the rack.</p>

4.2 Using ProSoft Configuration Builder (PCB) for Diagnostics

The *Configuration and Debug* menu for this module is arranged as a tree structure, with the *Main* menu at the top of the tree, and one or more submenus for each menu command. The first menu you see when you connect to the module is the *Main* menu.

Because this is a text-based menu system, you enter commands by typing the [command letter] from your computer keyboard in the *Diagnostic* window in *ProSoft Configuration Builder (PCB)*. The module does not respond to mouse movements or clicks. The command executes as soon as you press the [COMMAND LETTER] — you do not need to press [ENTER]. When you type a [COMMAND LETTER], a new screen will be displayed in your terminal application.

4.2.1 Using the Diagnostic Window in ProSoft Configuration Builder

To connect to the module's Configuration/Debug serial port

- 1 Start *PCB*, and then select the module to test. Click the right mouse button to open a shortcut menu.

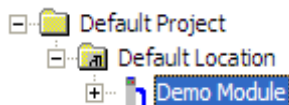

- 2 On the shortcut menu, choose **DIAGNOSTICS**.

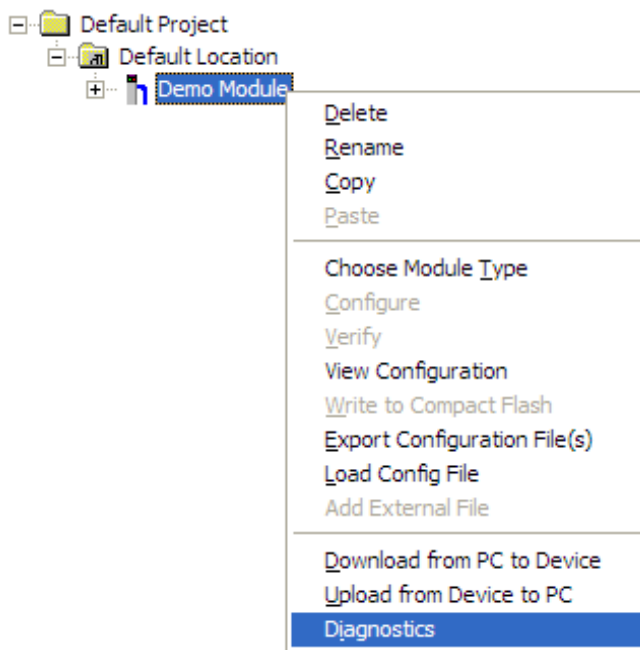

This action opens the *Diagnostics* dialog box.

- 3 Press [?] to open the *Main* menu.

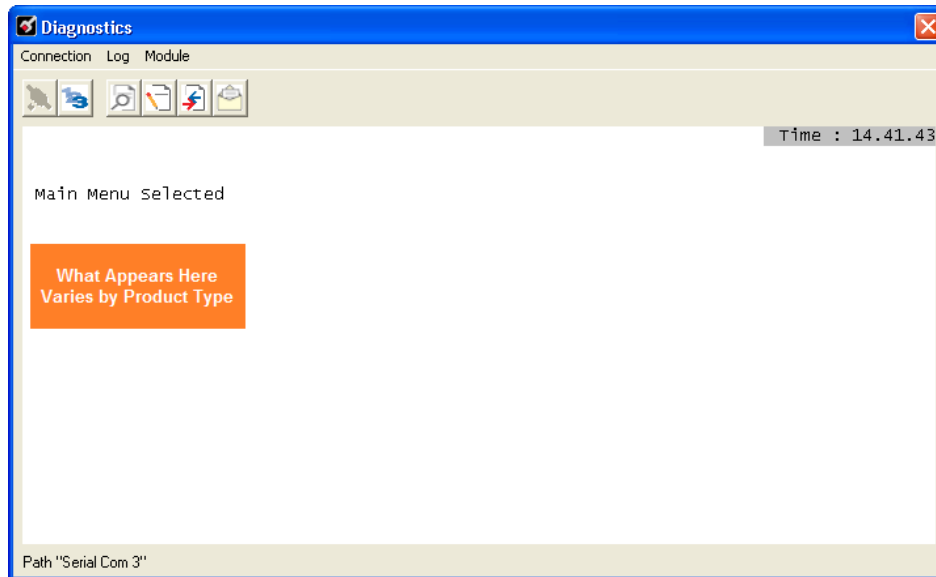

If there is no response from the module, follow these steps:

- 1 Click to configure the connection. On the *Connection Setup* dialog box, select a valid com port or other connection type supported by the module.

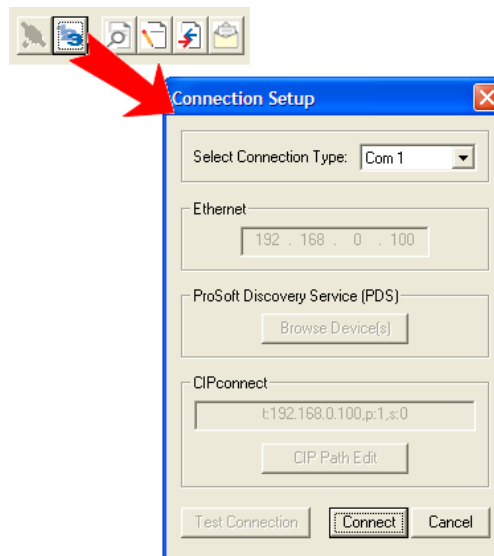

- 2 Verify that the null modem cable is connected properly between your computer's serial port and the module. A regular serial cable will not work.
- 3 On computers with more than one serial port, verify that your communication program is connected to the same port that is connected to the module.

If you are still not able to establish a connection, contact ProSoft Technology for assistance.

4.2.2 Navigation

All of the submenus for this module contain commands to redisplay the menu or return to the previous menu. You can always return from a submenu to the next higher menu by pressing **[M]** on your keyboard.

The organization of the menu structure is represented in simplified form in the following illustration:

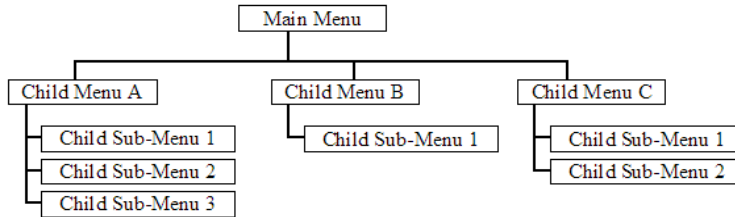

The remainder of this section shows the menus available for this module, and briefly discusses the commands available to you.

Keystrokes

The keyboard commands on these menus are usually not case sensitive. You can enter most commands in lowercase or uppercase letters.

The menus use a few special characters (**?**, **-**, **+**, **@**) that must be entered exactly as shown. Some of these characters will require you to use the **SHIFT**, **CTRL**, or **ALT** keys to enter them correctly. For example, on US English keyboards, enter the **?** command as **SHIFT** and **/**.

Also, take care to distinguish the different uses for uppercase letter "eye" (**I**), lowercase letter "el" (**L**), and the number one (**1**). Likewise, uppercase letter "oh" (**O**) and the number zero (**0**) are not interchangeable. Although these characters look alike on the screen, they perform different actions on the module and may not be used interchangeably.

4.2.3 Main Menu

When you first connect to the module from your computer, your terminal screen will be blank. To activate the main menu, press the [?] key on your computer's keyboard. If the module is connected properly, the following menu will appear.

```
GENERIC SERIAL COMMUNICATION MODULE MENU
?=Display Menu
A=Data Analyzer
B=Block Transfer Statistics
C=Module Configuration
U=Version Information
W=Warn Boot Module
Communication Status : 1=Port 1   2=Port 2
Port Configuration   : 6=Port 1   7=Port 2
Esc=Exit Program
```

Caution: Some of the commands available to you from this menu are designed for advanced debugging and system testing only, and can cause the module to stop communicating with the processor or with other devices, resulting in potential data loss or other failures. Only use these commands if you are specifically directed to do so by ProSoft Technology Technical Support staff. Some of these command keys are not listed on the menu, but are active nevertheless. Please be careful when pressing keys so that you do not accidentally execute an unwanted command.

Opening the Data Analyzer Menu

Press [A] to open the Data Analyzer Menu. Use this command to view all bytes of data transferred on each port. Both the transmitted and received data bytes are displayed. Refer to Data Analyzer (page 58) for more information about this menu.

Important: When in analyzer mode, program execution will slow down. Only use this tool during a troubleshooting session. Before disconnecting from the Config/Debug port, please press [S] to stop the data analyzer, and then press [M] to return to the main menu. This action will allow the module to resume its normal high speed operating mode.

Viewing Block Transfer Statistics

Press [B] from the *Main* menu to view the *Block Transfer Statistics* screen.

Use this command to display the configuration and statistics of the backplane data transfer operations between the module and the processor. The information on this screen can help determine if there are communication problems between the processor and the module.

Tip: To determine the number of blocks transferred each second, mark the numbers displayed at a specific time. Then some seconds later activate the command again. Subtract the previous numbers from the current numbers and divide by the quantity of seconds passed between the two readings.

Viewing Module Configuration

Press **[C]** to view the *Module Configuration* screen.

Use this command to display the current configuration and statistics for the module.

Viewing Version Information

Press **[V]** to view version information for the module.

Use this command to view the current version of the software for the module, as well as other important values. You may be asked to provide this information when calling for technical support on the product.

Values at the bottom of the display are important in determining module operation. The *Program Scan Counter* value is incremented each time a module's program cycle is complete.

Tip: Repeat this command at one-second intervals to determine the frequency of program execution.

Warm Booting the Module

Press **[W]** from the *Main* menu to warm boot (restart) the module.

This command will cause the program to exit and reload, refreshing configuration parameters that must be set on program initialization. Only use this command if you must force the module to reboot.

Viewing Port Communication Status

Press **[1]** or **[2]** from the Main Menu to view the port communication status for Ports 1 and 2.

Use this command to view communication status and statistics for the selected port. This information can be informative when troubleshooting communication problems.

Viewing Port Configuration

Press **[6]** or **[7]** from the Main Menu to view configuration information for ports 1 and 2.

Use this command to display detailed configuration information for the selected port.

Exiting the Program

Press **[ESC]** to restart the module and force all drivers to be loaded. The module will use the configuration stored in the module's Flash memory to configure the module.

Removing Timing Marks in the Data Analyzer

Press **[0]** to turn off timing marks in the Data Analyzer screen.

Viewing Data in Hexadecimal Format

Press **[H]** from the *Database View* menu to display the data on the current page in hexadecimal format.

Viewing Data in ASCII (Text) Format

Press **[A]** from the *Database View* menu to display the data on the current page in ASCII format. This is useful for regions of the database that contain ASCII data.

Starting the Data Analyzer

Press **[B]** to start the data analyzer. After the key is pressed, all data transmitted and received on the currently selected port will be displayed. The following illustration shows an example.

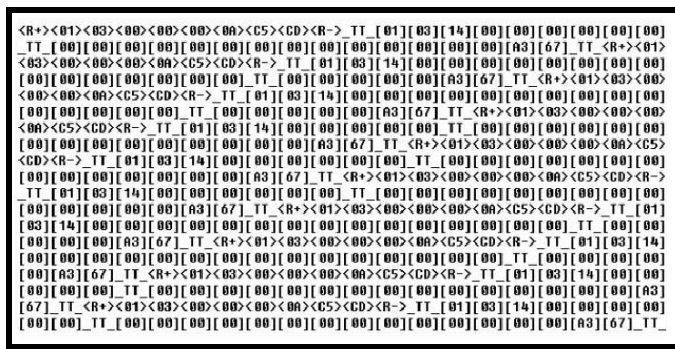

The Data Analyzer displays the following special characters:

Character	Definition
[]	Data enclosed in these characters represent data received on the port.
< >	Data enclosed in these characters represent data transmitted on the port.
<R+>	These characters are inserted when the RTS line is driven high on the port.
<R->	These characters are inserted when the RTS line is dropped low on the port.
<CS>	These characters are displayed when the CTS line is recognized high.
TT	These characters are displayed when the timing mark interval has been reached. This parameter is user defined.

Stopping the Data Analyzer

Press **[S]** to stop the data analyzer. Use this option to freeze the display so the data can be analyzed. To restart the analyzer, press **[B]**.

Important: When in analyzer mode, program execution will slow down. Only use this tool during a troubleshooting session. Before disconnecting from the Config/Debug port, please press **[S]** to stop the data analyzer, and then press **[M]** to return to the main menu. This action will allow the module to resume its normal high speed operating mode.

Returning to the Main Menu

Press **[M]** to return to the *Main* menu.

4.3 Reading Status Data from the Module

The MVI69-GSC module returns a 29-word Status Data block that can be used to determine the module's operating status. This data is located in the module's database at registers 6670 to 6698 and at the location specified in the configuration. This data is transferred to the CompactLogix processor continuously.

5 Reference

In This Chapter

❖ Product Specifications	62
❖ Functional Overview	65
❖ Cable Connections	72
❖ GSC Database Definition.....	77
❖ Status Data Definition	78

5.1 Product Specifications

The MVI69 Generic ASCII Serial Interface Module is a fast and easy way to add two fully configurable ASCII communication ports to the CompactLogix or MicroLogix platform without consuming the front port of the processor, or using valuable processing time.

The MVI69-GSC module is a single slot, backplane compatible solution for the CompactLogix or MicroLogix platform. This module has two powerful and fully configurable ASCII communication ports, each supporting the sending and receiving of large ASCII character strings. With the implementation of some supporting ladder logic in the processor, the many different devices supporting ASCII communications can be integrated into the CompactLogix or MicroLogix platform.

5.1.1 General Specifications

- Single-slot, 1769 backplane-compatible
- The module is recognized as an Input/Output module and has access to processor memory for data transfer between processor and module.
- Ladder Logic is used for data transfer between module and processor. Sample ladder file included.
- Configuration data obtained from configuration text file downloaded to module. Sample configuration file included.
- Supports all CompactLogix and MicroLogix 1500 LRP processors except 1769-L23E-QBFC1B, 1769-L16x, and 1769-L18x. Must have at least 800 mA of 5 Vdc backplane current available.

5.1.2 Hardware Specifications

Specification	Description
Dimensions	Standard 1769 Single-slot module
Current Load	800 mA max @ 5 VDC Power supply distance rating of 2 (L43 and L45 installations on first 2 slots of 1769 bus)
Operating Temp.	32° F to 140° F (0° C to 60°C)
Storage Temp.	-40° F to 185° F (-40° C to 85° C)
Relative Humidity	5% to 95% (with no condensation)
LED Indicators	Battery and Module Status Application Status Serial Port Activity CFG Port Activity
CFG Port (CFG)	RJ45 (DB-9F with supplied cable) RS-232 only No hardware handshaking
App Ports (P1,P2) (Serial modules)	RS-232, RS-485 or RS-422 (jumper selectable) RJ45 (DB-9F with supplied cable) RS-232 handshaking configurable 500V Optical isolation from backplane
Shipped with Unit	RJ45 to DB-9M cables for each port 6-foot RS-232 configuration Cable

5.1.3 Functional Specifications

- ASCII Communication ports 1 & 2 (PRT1, PRT2)
 - Both ports are capable of transmitting and/or receiving ASCII character strings. Each port is individually configurable:
 - Termination types
 - Stream mode
 - Termination character(s)
 - Message timeout
 - Intercharacter timeout
 - Packet size limit
 - Baud rate: 110 to 115.2K baud
 - Parity: none, even, odd
 - Stop bits: 1 or 2
 - Data bits: 5 to 8
 - RTS on/off timing: 0 to 65535 milliseconds
 - Minimum response delay: 0 to 65535 milliseconds
- Handshaking (optional)
 - Hardware: RTS/CTS, DTR/DSR
 - Software: XON/XOFF
- ASCII character strings up to 4096 characters in length supported
- Full hardware handshaking control provides radio, modem and multi-drop support
- User-definable module memory usage, supporting the storage and transfer of up to 4000 registers to/from the control processor
- Module error and status conditions returned to processor for diagnostic purposes
 - Module status
 - Port error status word (bit mapped)
 - Port receive state
 - Port receive character count
 - Port receive block count
 - Port transmit state
 - Port transmit character count
 - Port transmit block count
- All data related to the module is contained in a single controller tag with defined objects to simplify configuration, monitoring and interfacing with the module
- Module configuration and communication configuration data is transferred to the module via a predefined user data type in the processor

5.2 Functional Overview

5.2.1 General Concepts

The following discussion explains several concepts that are important for understanding module operation.

Module Power Up

On power up the module begins performing the following logical functions:

- 1 Initialize hardware components
 - Initialize CompactLogix or MicroLogix backplane driver
 - Test and Clear all RAM
 - Initialize the serial communication ports
- 2 Module configuration
- 3 Initialize Module Register space

After this initialization procedure is complete, the module will begin communicating with other devices on the network, depending on the configuration.

Main Logic Loop

Upon completing the power up configuration process, the module enters an infinite loop that performs the following functions:

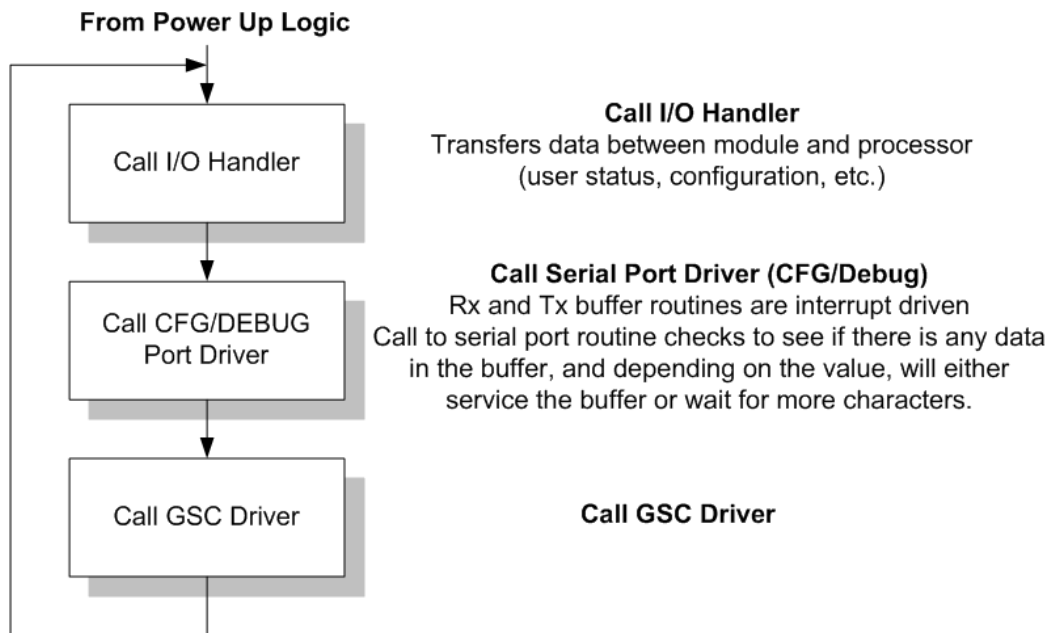

5.2.2 Data Flow between MVI69-GSC Module and CompactLogix Processor

The following topics describe the flow of data between the two pieces of hardware (CompactLogix processor and MVI69-GSC module) and other devices on the network under the module's different operating modes.

Backplane Data Transfer

The MVI69-GSC module communicates directly over the CompactLogix or MicroLogix backplane. Data is paged between the module and the CompactLogix processor across the backplane using the module's input and output images. The update frequency of the images is determined by the scheduled scan rate defined by the user for the module and the communication load on the module. Typical updates are in the range of 2 to 10 milliseconds.

The data is paged between the processor and the module using input and output image blocks (fixed at 60 words).

This bi-directional transference of data is accomplished by the module filling in data in the module's input image to send to the processor. Data in the input image is placed in the Controller Tags in the processor by the ladder logic.

The processor inserts data to the module's output image to transfer to the module. The module's program extracts the data and places it in the module's internal database.

The following illustration shows the data transfer method used to move data between the CompactLogix processor, the MVI69-GSC module and the network.

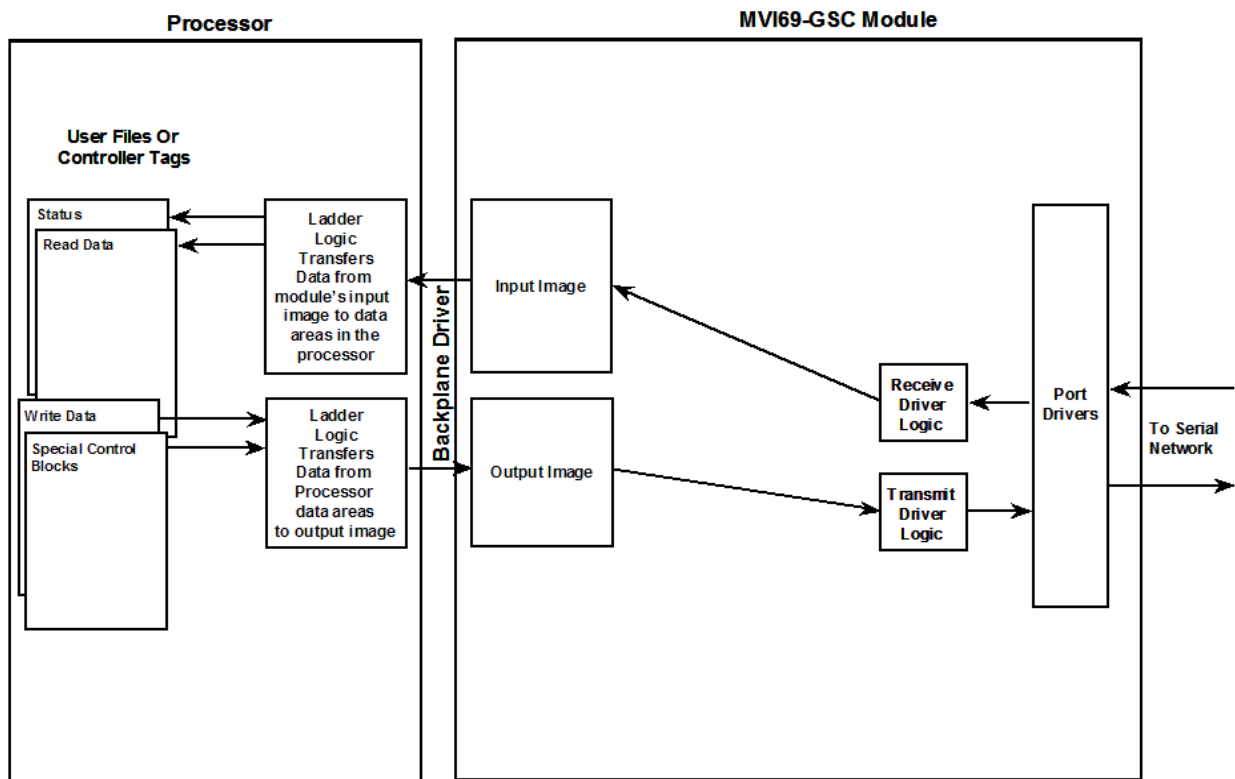

All data transferred between the module and the processor over the backplane is through the input and output images. Ladder logic must be written in the CompactLogix processor to interface the input and output image data with data defined in the Controller Tags. All data used by the module is stored in its internal database. The following illustration shows the layout of the database:

Module's Internal Database Structure

5000 registers for user data

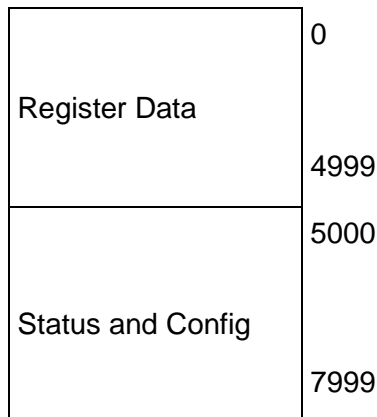

3000 words of configuration and status data

Data contained in this database is paged through the input and output images by coordination of the CompactLogix ladder logic and the MVI69-GSC module's program. Up to 60 words of data can be transferred from the module to the processor at a time. Up to 60 words of data can be transferred from the processor to the module. The read and write block identification codes in each data block determine the function to be performed or the content of the data block. The block identification codes used by the module are listed below:

Block Range	Descriptions
0 to 127	Normal Data Blocks for Read and Write
9998	Warm-boot control block
9999	Cold-boot control block

Each image has a defined structure depending on the data content and the function of the data transfer.

Normal Data Transfer

Normal data transfer includes the paging of the user data to and from the module's ports and bringing in status data. These data are transferred through read (input image) and write (output image) blocks. The structure and function of each block is discussed in the following topics:

Block Request from the Processor to the Module

These blocks of data are used to transfer information from the CompactLogix processor to the module. The structure of the output image used to transfer this data is shown below:

	Word Offset	Description
Port 1	0	Block Sequence Number (Read block number as sent by module) (0 to 127)
	1	Inter-character delay for this message (milliseconds between characters)
	2	Number of characters to transmit on Port 1 (0 to 50)
	3 to 27	Port 1 ASCII character codes to transmit (up to 50 ASCII characters)
Port 2	28	Inter-character delay for this message (milliseconds between characters)
	29	Number of characters to transmit on Port 2 (0 to 50)
	30 to 54	Port 2 ASCII character codes to transmit (up to 50 ASCII characters)
	55 to 59	Reserved

The Block Sequence Number is that received on the last read block transfer through the input image on the module. The ladder logic should copy this value from byte 0 of the input image to byte 0 of output image in the ladder logic. This must be the last operation performed when constructing the write block. The module’s program will trigger the process write block function when a new value is recognized in byte 0 of the output image. If the number of characters to transmit in the write block is not set to zero (non-zero value in bytes 2 and 29), this indicates to the module there is data present in the block that needs to be transmitted. If the selected port is not already busy transmitting data from a previous write block, the data in the block will be moved to the port’s transmit buffer and sent out the port as soon as possible.

In order to pace the characters for the write operation, an inter-character delay value is associated with each write message. For devices that do not buffer received data, when interfacing with a modem in command mode or when simulating keyboard or keypad entry, inter-character delays may be required. For example, if the port is tied to a device that expects input with delays of 200 milliseconds between each character, place the data to send in the write block output image along with the length and set the inter-character delay byte (bytes 1 and 28) to a value of 200 in the module’s output image in the processor’s ladder logic program. The message will be transmitted with a 200-millisecond wait period between each character. Because this delay value is sent from the processor for each write message, the inter-character delay can be set independently for each message. For example, when writing AT commands to a dial-up modem, an inter-character delay of 100 may be required. But when the modem is in data mode, the inter-character delay can be set to 0. When the delay is set to 0, the whole packet of data will be placed in the module’s transmit buffer at one time.

Block Response from the Module to the Processor

These blocks transfer information from the module to the processor. The structure of the input image used to transfer these data is shown below. The Block Sequence Number (byte 0) is an index value used to signal to the processor that a new block is ready for processing. The ladder logic must recognize a change in this value and process the data encapsulated in the input image. The block contains the data received on each port and status data. The two byte values in bytes 1 (port 1 receive length), and 28 (port 2 receive length), hold the number of characters received on each port to be processed by the ladder logic. ASCII character code data received on the ports are found starting at byte 3 and 30 for Port 1 and 2, respectively. The simpler version of the example ladder logic assumes the number of ASCII characters received on each port is less than or equal to fifty characters (25 words per port, times 2 characters per word).

	Word Offset	Description
	0	Block Sequence Number (Bumped each scan by module) (0 to 127)
Port 1	1	Number of characters (0 to 50) in Port 1 receive block (3 to 27). If the string received on the port is larger than 50 characters, multiple blocks will be transferred. Any block with a value of -1 in this field represents the first or continuation block and the block contains 50 characters of ASCII code data. The last block of data will contain a positive number in this field that represents the number of characters in the last block. Status data will be returned in words 3 to 27 if this word contains a value of 0.
	2	Number of characters transmitted (0 to 50) from last block write for Port 1
	3 to 27	Port 1 data received (up to 50 ASCII character codes of data). If the number of characters received for the port is 0, status data will be returned in this area.
Port 2	28	Number of characters (0 to 50) in Port 2 receive block (30 to 54). If the string received on the port is larger than 50 bytes, multiple blocks will be transferred. Any block with a value of -1 in this field represents the first of continuation block and the block contains 50 characters of ASCII code data. The last block of data will contain a positive number in this field that represents the number of characters in the last block. Status data will be returned in words 30 to 54 if this word contains a value of 0.
	29	Number of characters transmitted (0 to 50) from last block write for Port 2
	30 to 54	Port 2 data received (up to 50 ASCII character codes of data). If the number of characters received for the port is 0, status data will be returned in this area
	55 to 59	Reserved

The receive buffer in the module can hold up to 4096 characters. This large size permits the buffering of a large amount of data before a transfer of the data to the controller is required. The module buffers incoming ASCII characters in its receive buffer until one of the user-specified termination conditions is recognized. The module will then transfer the received terminated string to the controller.

The ladder logic required to properly handle transfer of terminated strings longer than 50 characters per port is more complex than the simpler version of ladder logic discussed above. If the terminated string is larger than 50 characters, multiple blocks will be used to transfer the data to the controller. The first block will contain a value of -1 in the "Number of Characters Received" data field. This indicates that there will be more blocks to follow and that the current block contains 50 ASCII character codes. As long as more than 50 characters remain in the buffer waiting to be sent to the ladder logic, successive Read Blocks will continue to show the "Number of Characters Received" as -1. When 50 or fewer ASCII characters remain in the buffer, the module will send the last block with a positive number in the length field. The value passed represents the number of characters present in the data area, which is the last characters of the complete, terminated string. The ladder logic must recognize the presence of one or more successive blocks with -1 lengths and then the positive number of the last block as indication that a single, complete, long string has been completely transferred.

The two byte values at bytes 1 (port 1 transmit count) and 29 (port 2 transmit count) inform the processor of the number of ASCII characters transferred in the last write block to the respective port transmit buffers. If a value of zero is returned in one of these words and data was sent in the last write block, the ladder logic must re-send the data in the next write block because the port was in a busy state and could not transmit the last data to be written at the time the Write Block was received by the module from the ladder logic. If a non-zero value is returned in one of these bytes, the value represents the number of ASCII characters from the last write block that were successfully moved into the port's transmit buffer.

The status information transferred in the read block can be used by the processor to determine the state and "health" of the module and the device(s) attached to each application port. An important member of the value in the status object is error word for each port. This value contains the configuration error flags for each port and the receive buffer overflow error flag.

5.2.3 Special Function Blocks

Special Function blocks are blocks used to control the module or request special data from the module. The current version of the software supports two Special Functions, warm boot and cold boot.

Warm Boot Block (9998)

This block is sent from the CompactLogix or MicroLogix processor to the module (output image) when the module is required to perform a warm-boot (software reset) operation. The following table describes the format of the control block.

Offset	Description	Length
0	9998	1
1	Spare	

Cold Boot Block (9999)

This block is sent from the CompactLogix or MicroLogix processor to the module (output image) when the module is required to perform the cold boot (hardware reset) operation. This block is sent to the module when a hardware problem is detected by the ladder logic that requires a hardware reset. The following table describes the format of the control block.

Offset	Description	Length
0	9999	1
1	Spare	

5.3 Cable Connections

The application ports on the MVI69-GSC module support RS-232, RS-422, and RS-485 interfaces. Please inspect the module to ensure that the jumpers are set correctly to correspond with the type of interface you are using.

Note: When using RS-232 with radio modem applications, some radios or modems require hardware handshaking (control and monitoring of modem signal lines). Enable this in the configuration of the module by setting the UseCTS parameter to 1.

5.3.1 RS-232 Configuration/Debug Port

This port is physically an RJ45 connection. An RJ45 to DB-9 adapter cable is included with the module. This port permits a PC based terminal emulation program to view configuration and status data in the module and to control the module. The cable for communications on this port is shown in the following diagram:

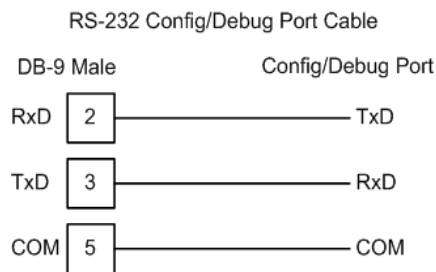

5.3.2 RS-232 Application Port(s)

When the RS-232 interface is selected, the use of hardware handshaking (control and monitoring of modem signal lines) is user definable. If no hardware handshaking will be used, here are the cable pinouts to connect to the port.

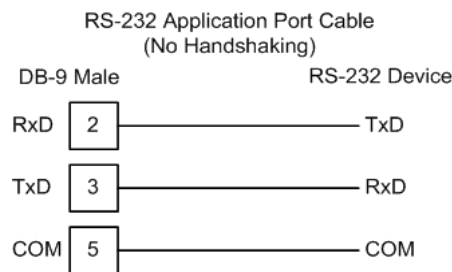

RS-232: Modem Connection (Hardware Handshaking Required)

This type of connection is required between the module and a modem or other communication device.

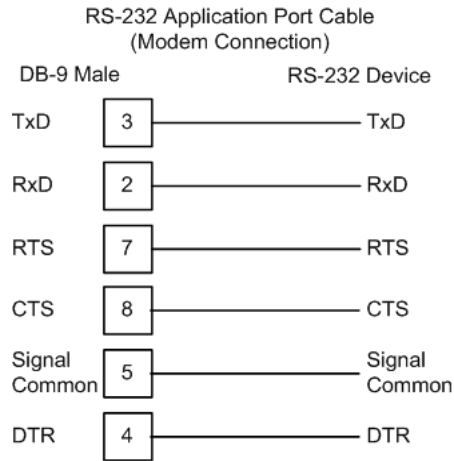

The "Use CTS Line" parameter for the port configuration should be set to 'Y' for most modem applications.

RS-232: Null Modem Connection (Hardware Handshaking)

This type of connection is used when the device connected to the module requires hardware handshaking (control and monitoring of modem signal lines).

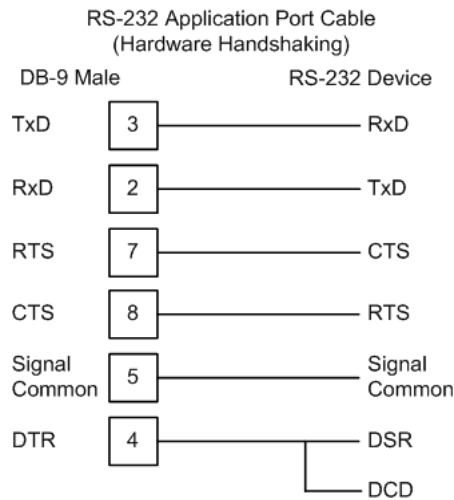

RS-232: Null Modem Connection (No Hardware Handshaking)

This type of connection can be used to connect the module to a computer or field device communication port.

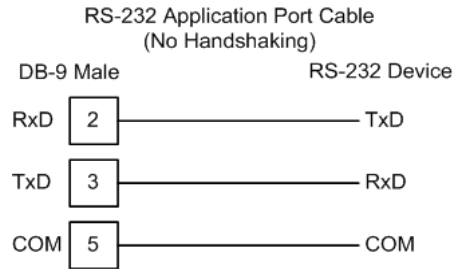

Note: For most null modem connections where hardware handshaking is not required, the *Use CTS Line* parameter should be set to **N** and no jumper will be required between Pins 7 (RTS) and 8 (CTS) on the connector. If the port is configured with the *Use CTS Line* set to **Y**, then a jumper is required between the RTS and the CTS lines on the port connection.

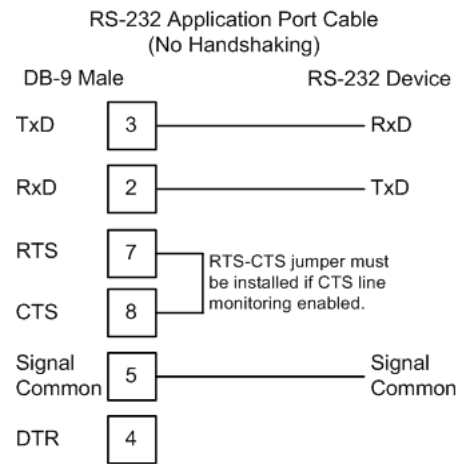

5.3.3 RS-422

The RS-422 interface requires a single four or five wire cable. The Common connection is optional, depending on the RS-422 network devices used. The cable required for this interface is shown below:

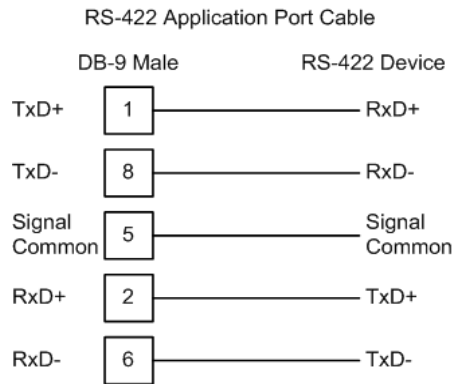

5.3.4 RS-485 Application Port(s)

The RS-485 interface requires a single two or three wire cable. The Common connection is optional, depending on the RS-485 network devices used. The cable required for this interface is shown below:

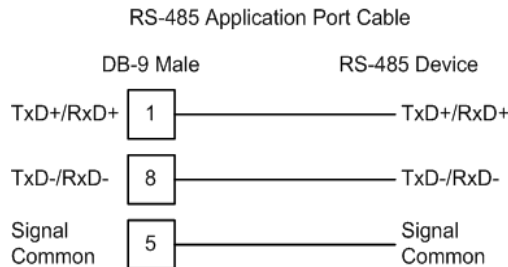

Note: Terminating resistors are generally not required on the RS-485 network, unless you are experiencing communication problems that can be attributed to signal echoes or reflections. In these cases, installing a 120-ohm terminating resistor between pins 1 and 8 on the module connector end of the RS-485 line may improve communication quality.

RS-485 and RS-422 Tip

If communication in the RS-422 or RS-485 mode does not work at first, despite all attempts, try switching termination polarities. Some manufacturers interpret + and -, or A and B, polarities differently.

5.3.5 DB9 to RJ45 Adaptor (Cable 14)

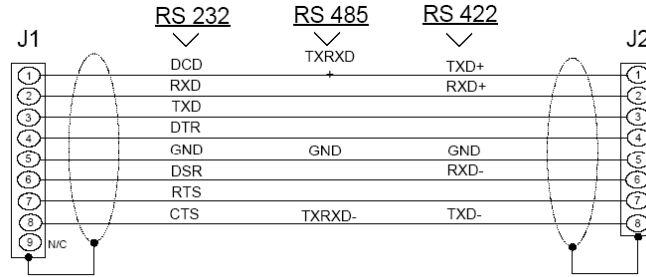
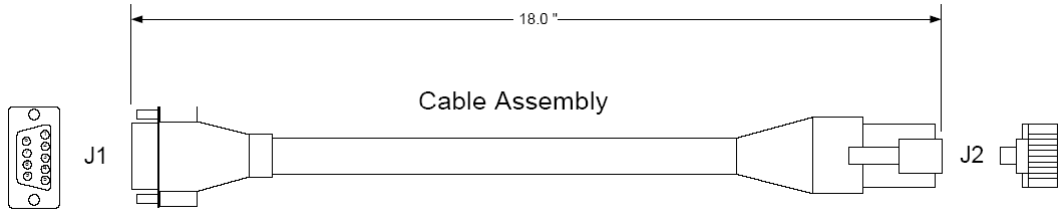

Wiring Diagram

5.4 GSC Database Definition

This section contains a listing of the internal database of the MVI69-GSC module. This information can be used to interface other devices to the data contained in the module.

Register Range	Content	Size
0 to 4999	User Data	5000
5000 to 5009	Backplane Configuration	10
5010 to 5039	Port 1 Setup	30
5040 to 5069	Port 2 Setup	30
5070 to 5869	Port 1 Commands	800
5870 to 6669	Port 2 Commands	800
6670 to 6702	Misc. Status Data	32
6703 to 6749	Reserved	
6750 to 6759	Port 1 Status Data	10
6760 to 6769	Port 2 Status Data	10

The User Data area holds data collected from other nodes on the network (master read commands) or data received from the processor (write blocks). Additionally, this data area is used as a data source for the processor (read blocks) or other nodes on the network (write commands).

Detailed definition of the miscellaneous status data area and configuration data areas can be found in the Reference chapter.

5.5 Status Data Definition

This section contains a description of the members present in the **GSCStatus** object. This data is transferred from the module to the processor as part of each read block.

Object in GSCInStat	Block Offset	Description
PassCnt	3	Program cycle counter
Product	4 to 5	Product name as ASCII string
Rev	6 to 7	Revision level as ASCII string
OP	8 to 9	Operating system level as ASCII string
Run	10 to 11	Run number as ASCII string
BlkErrs.Read	12	Number of blocks transferred from module to processor
BlkErrs.Write	13	Number of blocks transferred from processor to module
BlkErrs.Parse	14	Number of blocks parsed by module
BlkErrs.Err	15	Number of block errors in module
Port[0].RxState	16	Port 1 receive state: -1 = Listening for data 1 = Receiving Port Data 2 = Waiting for Backplane transfer
Port[0].RXCharCnt	17	Port 1 receive character count
Port[0].RxMsgCnt	18	Port 1 receive block count
Port[0].TxState	19	Port 1 transmit state: 0 = Waiting for Data to Send 1 = RTS On 2 = RTS Timeout 3 = Sending data 4 = Waiting for RTS Off 5 = RTS turned off 30 = Intercharacter Delay 31 = Intercharacter Delay 32 = Intercharacter Delay 100 = Message Delay before Transmit 101 = Message Delay before Transmit
Port[0].TxCharCnt	20	Port 1 transmit character count
Port[0].TxMsgCnt	21	Port 1 transmit block count
Port[0].ErrorWord	22	Port 1 error word
Port[1].RxState	30	Port 2 receive state: -1 = Listening for data 1 = Receiving Port Data 2 = Waiting for Backplane transfer
Port[1].RXCharCnt	31	Port 2 receive character count
Port[1].RxMsgCnt	32	Port 2 receive block count

Object in GSCInStat	Block Offset	Description
Port[1].TxState	33	Port 2 transmit state: 0 = Waiting for Data to Send 1 = RTS On 2 = RTS Timeout 3 = Sending data 4 = Waiting for RTS Off 5 = RTS turned off 30 = Intercharacter Delay 31 = Intercharacter Delay 32 = Intercharacter Delay 100 = Message Delay before Transmit 101 = Message Delay before Transmit
Port[1].TxCharCnt	34	Port 2 transmit character count
Port[1].TxMsgCnt	35	Port 2 transmit block count
Port[1].ErrorWord	36	Port 2 error word

GSSErrorWord Definition

Member Name	Bit in Word	Description
Cfg_type	Bit 0	The termination type configured for the port is not valid. Values between 0 and 15 are the only ones valid. The module will use type 0 (stream mode) for the port.
Cfg_Baud	Bit 1	The baud rate entered for the port is not valid. The module will use 9600 baud for the port.
Cfg_Parity	Bit 2	The parity value entered is not valid. Values between 0 and 4 are accepted. The module has set the parity to a value of none (0).
Cfg_DataBits	Bit 3	The number of data bits for the protocol is not valid. Values between 5 and 8 are accepted. The module assumes a value of 8 data bits.
Cfg_StopBits	Bit 4	The number of stop bits for the protocol is not valid. Values of 1 or 2 are accepted. The module assumes a value of 1 stop bit.
Cfg_Handshake	Bit 5	The handshake code for the port is not valid. The value entered must be in the range of 0 to 3. The module assumes a value of 0 (no handshaking).
Cfg_Rtermcount	Bit 6	The number of termination characters is not valid. The value must be set between 1 and 12 when using the termination character string to end a receive buffer. The module will not terminate a buffer when using the termination character(s) when this bit is set.
Cfg_RPacketLen	Bit 7	The number of characters for a packet is not valid. The value must be set between 1 and 4096 when the packet size termination option is used. The module will not use the packet length termination option when this bit is set.
Cfg_Rtimeout	Bit 8	The message timeout value is set to zero. The module will not use the message timeout termination option when this bit is set.
Cfg_Rdelay	Bit 9	The intercharacter delay value configured is set to zero. The module will not use the intercharacter delay option when this bit is set.
Cfg_Wtimeout	Bit 10	The write message timeout parameter is set to zero. The module assumes a value of 5000 milliseconds.
	Bit 11	
	Bit 12	
	Bit 13	
	Bit 14	
Err_ROverflow	Bit 15	Data is being received faster on the port than the ladder logic can process the read blocks. Alter the configuration of the module or the connected device. Receive data is being lost.

6 Support, Service & Warranty

6.1 Contacting Technical Support

ProSoft Technology, Inc. is committed to providing the most efficient and effective support possible. Before calling, please gather the following information to assist in expediting this process:

- 1 Product Version Number
- 2 System architecture
- 3 Network details

If the issue is hardware related, we will also need information regarding:

- 1 Module configuration and associated ladder files, if any
- 2 Module operation and any unusual behavior
- 3 Configuration/Debug status information
- 4 LED patterns
- 5 Details about the interfaced serial, Ethernet or Fieldbus devices

Note: For technical support calls within the United States, ProSoft's 24/7 after-hours phone support is available for urgent plant-down issues.

North America (Corporate Location)	Europe / Middle East / Africa Regional Office
Phone: +1.661.716.5100 info@prosoft-technology.com Languages spoken: English, Spanish REGIONAL TECH SUPPORT support@prosoft-technology.com	Phone: +33.(0)5.34.36.87.20 france@prosoft-technology.com Languages spoken: French, English REGIONAL TECH SUPPORT support.emea@prosoft-technology.com
Latin America Regional Office	Asia Pacific Regional Office
Phone: +52.222.264.1814 latinam@prosoft-technology.com Languages spoken: Spanish, English REGIONAL TECH SUPPORT support.la@prosoft-technology.com	Phone: +60.3.2247.1898 asiapc@prosoft-technology.com Languages spoken: Bahasa, Chinese, English, Japanese, Korean REGIONAL TECH SUPPORT support.ap@prosoft-technology.com

For additional ProSoft Technology contacts in your area, please visit:
<https://www.prosoft-technology.com/About-Us/Contact-Us>.

6.2 Warranty Information

For complete details regarding ProSoft Technology's TERMS & CONDITIONS OF SALE, WARRANTY, SUPPORT, SERVICE AND RETURN MATERIAL AUTHORIZATION INSTRUCTIONS, please see the documents at:
www.prosoft-technology/legal

Index

A

- Adding Multiple Modules (Optional) • 22
- Adding the Module to an Existing CompactLogix Project • 15, 44
- Adding the Module to an Existing MicroLogix Project • 47
- Analyzing Data for the first application port • 58
- Analyzing Data for the second application port • 58

B

- Backplane Data Transfer • 66
- Battery Life Advisory • 4
- Block Request from the Processor to the Module • 68
- Block Response from the Module to the Processor • 69

C

- Cable Connections • 72
- Changing Parameters During Operation • 41
- Clearing a Fault Condition • 51
- Cold Boot Block (9999) • 71
- Configuration Data • 37
- Configuring Module Parameters • 35
- Configuring the MVI69-GSC Module • 14
- Configuring the RSLinx Driver for the PC COM Port • 30
- Connect your PC to the Module • 32
- Connecting Your PC to the Processor • 28
- Create a new RSLogix5000 project • 15
- Create the Module • 16

D

- Data Analyzer • 56, 58
- Data Flow between MVI69-GSC Module and CompactLogix Processor • 66
- DB9 to RJ45 Adaptor (Cable 14) • 76
- Diagnostics and Troubleshooting • 48, 49
- Displaying Timing Marks in the Data Analyzer • 58
- Downloading the Project to the Module Using a Serial COM port • 42
- Downloading the Sample Program to the Processor • 29, 46

E

- Exiting the Program • 57

F

- Functional Overview • 65
- Functional Specifications • 64

G

- General Concepts • 65
- General Specifications • 62
- GSC Database Definition • 77

H

- Hardware Specifications • 63
- How to Contact Us • 2

I

- Import the Ladder Rung • 19
- Important Installation Instructions • 3
- Install the Module in the Rack • 11
- Installing ProSoft Configuration Builder Software • 10

K

- Keystrokes • 55

L

- Ladder Logic • 43
- LED Status Indicators • 50

M

- Main Logic Loop • 65
- Main Menu • 56
- Markings • 4
- Module Power Up • 65
- MVI (Multi Vendor Interface) Modules • 3
- MVI69-GSC Sample Add-On Instruction Import Procedure • 15, 44

N

- Navigation • 55
- Normal Data Transfer • 67

O

- Opening the Data Analyzer Menu • 56

P

- Package Contents • 9
- Pinouts • 3, 72, 76
- Printing a Configuration File • 36
- Product Specifications • 62

R

- Reading Status Data from the Module • 60
- Reference • 61
- Removing Timing Marks in the Data Analyzer • 59
- Renaming PCB Objects • 35
- Returning to the Main Menu • 60
- RS-232
 - Modem Connection (Hardware Handshaking Required) • 73
 - Null Modem Connection (Hardware Handshaking) • 73
 - Null Modem Connection (No Hardware Handshaking) • 74
- RS-232 Application Port(s) • 72
- RS-232 Configuration/Debug Port • 72
- RS-422 • 75
- RS-485 and RS-422 Tip • 75
- RS-485 Application Port(s) • 75

S

Setting Jumpers • 10
Setting Up the Project • 33
Special Function Blocks • 71
Start Here • 7
Starting the Data Analyzer • 59
Status Data Definition • 78
Stopping the Data Analyzer • 60
Support, Service & Warranty • 81
System Requirements • 8

T

Troubleshooting • 52

U

Using ProSoft Configuration Builder • 33
Using ProSoft Configuration Builder (PCB) for Diagnostics •
53
Using the Diagnostic Window in ProSoft Configuration
Builder • 53

V

Viewing Block Transfer Statistics • 56
Viewing Data in ASCII (Text) Format • 59
Viewing Data in Hexadecimal Format • 59
Viewing Module Configuration • 57
Viewing Port Communication Status • 57
Viewing Port Configuration • 57
Viewing Version Information • 57

W

Warm Boot Block (9998) • 71
Warm Booting the Module • 57
Warnings • 3
Warranty Information • 81

Y

Your Feedback Please • 2