

1010100
1010101
0101011
1110001

WHERE AUTOMATION CONNECTS

Communication Solutions for **Rockwell Automation®** Users



Table of Contents

Ethernet and Serial Gateway Solutions	2
Automotive and Inertial Navigation Gateways	2
Serial & Ethernet Modbus® Solutions	3
Scalable Modbus® & Modbus® TCP Solutions for Compact Logix™	3
Secure Remote Connectivity	4
In-Chassis Flow Computer Solutions	6
HART Solutions	6
Power and Energy Solutions	7
DNP3 Solutions	7
Modernization Solutions	8
PROFIBUS Solutions	10
Enterprise Connectivity	11
Leverage the IIoT	11
Automated Material Handling	12
Radiating Cable 2.4 and 5 GHz Band	14
802.11n (abgn) Fast Watertight Industrial Hotspots	14
Wireless Support from Trusted Experts	15
Wireless Comparison Product Selection Chart	16
In-Chassis Product Selection Chart	17
Stand-Alone Gateways Product Selection Chart	18

Ethernet and Serial Gateway Solutions

ProSoft Technology's stand-alone, DIN rail-mounted industrial gateways provide a means to read or write data from devices using dissimilar protocols. All gateways come with our ProSoft Discovery Service feature. With PDS, you don't have to change your PC to the default subnet of the module, saving you time during setup.

Building Automation solutions – including QuickServer gateways – bring key operational data directly to your Rockwell Automation controller. Use these solutions to boost energy efficiency, use the resource most productively, and decrease your usage and costs.

The Modbus Router enables EtherNet/IP™, Modbus TCP/IP and Modbus RTU connectivity for field devices. In addition to its gateway functionality, the module also functions a router, forwarding Modbus data from the unit's serial ports to its Ethernet port.



- Gateways with two Ethernet ports allow you to isolate networks, passing only the data you want between devices
- EtherNet/IP™ gateways support multiple I/O connections for fast real-time data
- Remote configuration and diagnostics via Ethernet
- SD Card slot for disaster recovery of configuration data
- Up to four Serial ports

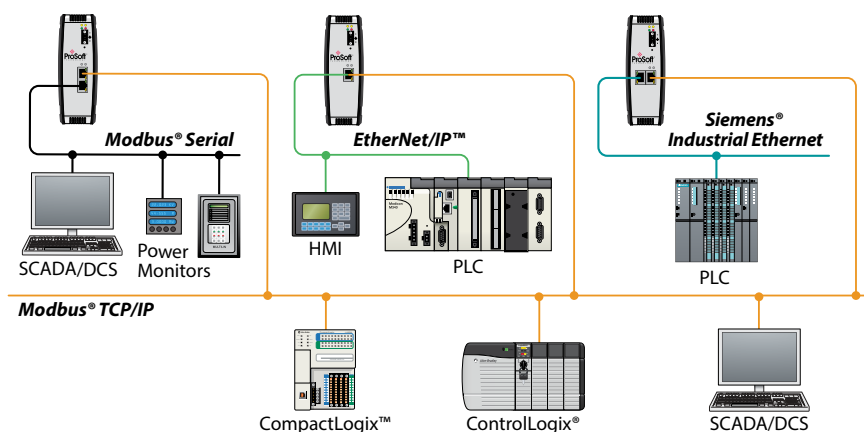

PROFIBUS DP & many other protocols are also available.

Automotive and Inertial Navigation Gateways

- The **CANOpen Router** is an ideal solution for motion-oriented machine control systems, primarily in automotive applications. The module supports EtherNet/IP to CANOpen communications, and can support either Master or Slave mode
- The **J1939 Router** enables automotive diagnostic communications via EtherNet/IP between Logix controllers and J1939 devices. The module is used to facilitate automatic unpacking and scaling of J1939 devices' data to your controller's UDT structure, saving you time
- The **Time Sync Module** enables precise time syncing with Logix controllers and HMIs, and provides GPS data as well for inertial navigation applications. Velocity and odometer data is available thanks to the onboard GPS receiver. This module can also be used as a replacement for Rockwell Automation's discontinued 1756-TIME solution
- The **XPosition Module** delivers highly precise location data from GPS or inertial navigation devices, ensuring you know the placement of your crane system, marine crafts, or drilling equipment

Serial & Ethernet Modbus® Solutions



Modbus® Serial

- Module configuration stored within the Studio 5000®/RSLogix™ 5000 project (ACD file) for simplified disaster recovery
- Add-On Profile (AOP) improves integration into Studio 5000/RSLogix 5000
- Add-On Instruction (AOI) reduces configuration effort and simplifies maintenance
- Modules also available for the Logix-XT platform; support operations in extreme environments at higher operating temperatures, and have a conformal coating to protect them in harsh conditions



Modbus® TCP/IP

- Fast Multi-Server/Multi-Client capabilities
- Add-On Instruction reduces configuration effort and simplifies maintenance

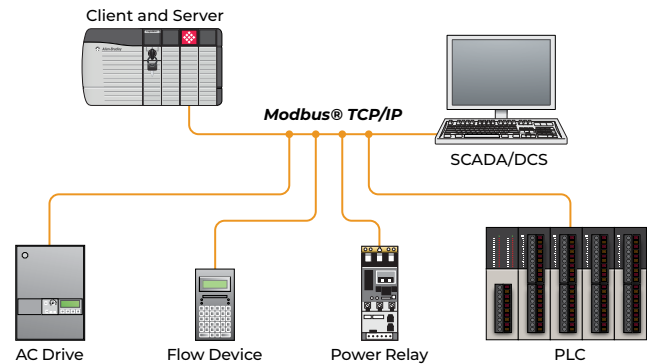
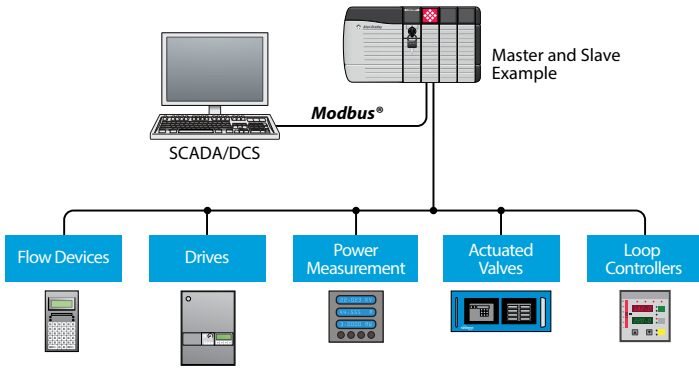

Scalable Modbus® & Modbus® TCP Solutions for CompactLogix™



- Enhanced modules allow up to 10,000 I/O words
- Lite modules allow up to 240 I/O words
- Integrated Modbus® Serial communications in 1734 Point I/O™ applications

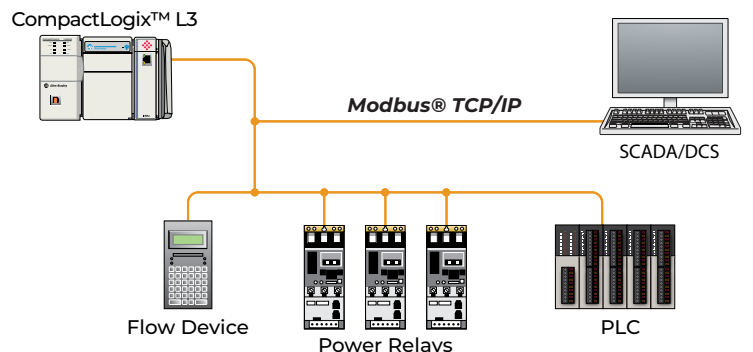
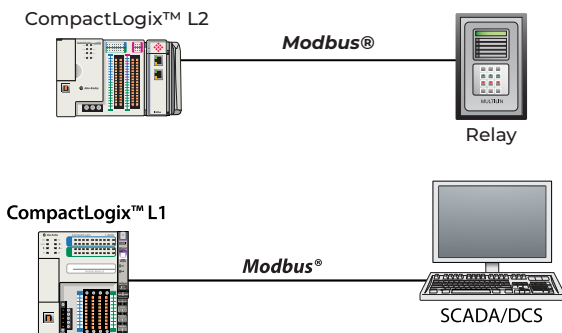



Secure Remote Connectivity

Our Secure Remote Access suite, easy to use by design, provides IT-secure and OT-friendly solutions that help you connect to your equipment anywhere, at any time. Remote access gateways and always-on networks can be monitored securely and easily in Belden Horizon™ Console, part of Belden Horizon.

We aim to make remote access as secure and streamlined as possible, and put the end user in the driver's seat, ensuring complete access control of remote equipment. Our remote access solutions feature:

- Virtual Lockout-Tagout feature for greater access control of specific equipment
- A multi-layered Defense-in-Depth approach to security, including advanced two-factor authentication (we avoid the less-secure SMS mode of authentication) and Active Directory support via Single Sign-On (SSO), which means you can access Belden Horizon with your corporate login credentials
- Role-based device and user access
- No software updates on your part – no user-installed software means you'll eliminate an entry point for hackers, and save time for your team
- OpenVPN support: One-time-use tunnels provide a secure connection between your equipment and Belden Horizon
- Layer 2 Tunneling Protocol (L2TP)/IPsec and Secure Socket Tunneling Protocol (SSTP) support increases VPN security for all popular clients, including Windows, iOS, and Android products, and easily allows you to see your remote devices rather than try to remember them
- Support for SMS messaging from your EtherNet/IP or Modbus TCP/IP PAC (Cellular Gateway only)

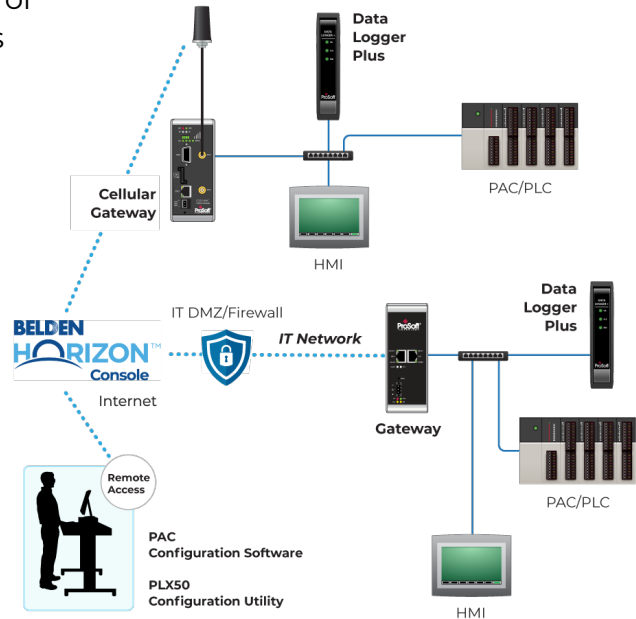

Persistent Data Network (PDN) Always-on, secure, and managed cloud- based network to connect geographically dispersed remote sites.

This simple, secure solution is ideal for infrastructure communications networks.

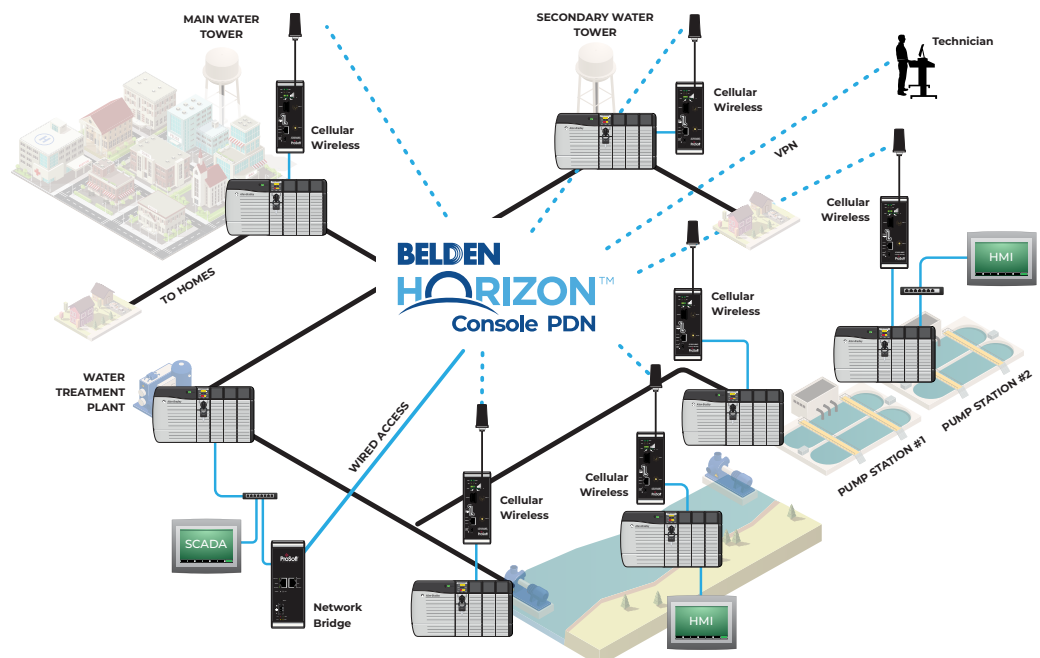

Gateways



Industrial Cellular Gateway (ICX35-HWC)

- 4G LTE cellular or wired access via WAN/LAN port
- Ethernet port available for Internet connection or SIM card
- Monitor and manage via Belden Horizon Console



Data Logger Plus (PLX51-DLplus-232)

- Ideal for remote sites with limited communications that need to log data (stores over 16M records!)
- Can help OEMs identify operational issues and improve OEE
- Data can be downloaded as a .csv file
- Support for 200 tags; minimum log interval: 50 milliseconds
- Features support for JSON interface, enabling easy exporting of logged data to business CRM systems
- Features an integrated webserver to trend variables and upload logged data
- XLReporter connection available



Network Bridge (PLX35-NB2)

- Wired remote access
- Monitor and manage via Belden Horizon Console
- Enable / Disable remote access locally via an EtherNet/IP message
- File Relay – transfer files across segmented networks



Belden Horizon Console

- EasyBridge™ technology enables your PC to act like it is connected directly to a switch on the remote network
- Allows software tools, such as RSWho and Studio 5000, to work without routing
- Multi-layered defense-in-depth approach, including support for Active Directory (SSO) and token-based 2F Authentication, keeps your data and equipment safe

Belden Horizon Lite App

What if you're not at your desk or office when the customer call comes in, or sitting on a beach and your customer calls with a critical issue? You don't have to give up that view or worry you'll upset your customer - Belden Horizon has gone mobile, and the app is available to download on the iOS platform! App Store is a trademark of Apple Inc.



Case Study: Wastewater Monitoring via Always-On Managed Network
psft.com/DC4

Case Study: Oil and Gas Company Now Remotely Monitoring Operation
psft.com/DCE

Case Study: Monitoring a City's Remote Lift Stations
psft.com/C19



In-Chassis Flow Computer Solutions

For Multi-Well Pad and LACT Applications

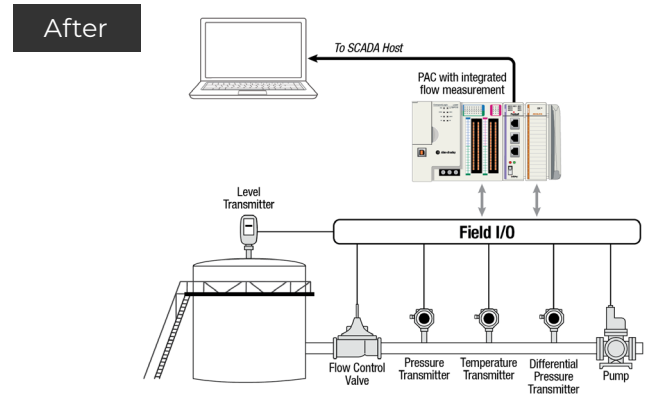
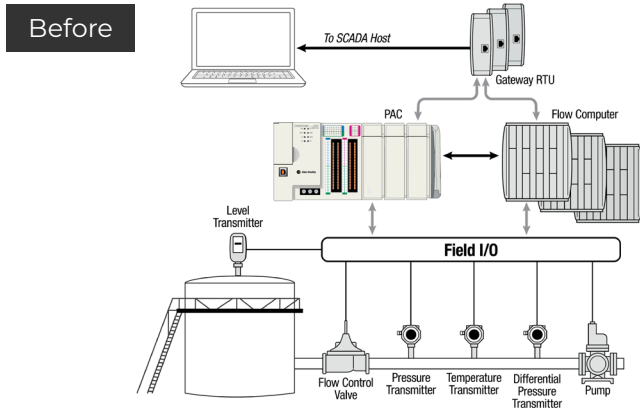

ControlLogix®



CompactLogix™

- Supports 8-16 meter runs with 4 streams per meter run for the measurement of hydrocarbon gases and liquids
- In-chassis solution brings data directly into your ControlLogix® or CompactLogix™; helps minimize cabinet space
- Pair with Rockwell Automation's distributed I/O capability + ProSoft's wireless radios to reduce wiring to transmitters and I/O devices
- Includes the use of EAFC Manager, a free Windows 7-based tool for configuration, reporting, and monitoring; hourly or daily archives with user-selected data are available
- NMI certified for OIML, WELMEC, and MID type approval (AGA/API)
- No additional licensing fee for liquid meter runs
- Add another AFC card in same chassis if more meter runs are required
- Secure data archiving / meter run
- Archive records stored in non-volatile memory in module
- Archive data cannot be altered/changed
- Integration to SCADA with Modbus/Enron Modbus support (Cygnnet, Autosol, and FlowCal)
- System designs can support more than 80 metering locations

Case Study: ProSoft's integrated flow computer helped Pelican Gathering decrease the number of components, minimize their panel space, and streamline integration. psft.com/DCE

HART Solutions

Gain additional diagnostic information from your distributed process equipment – and boost efficiency as a result.

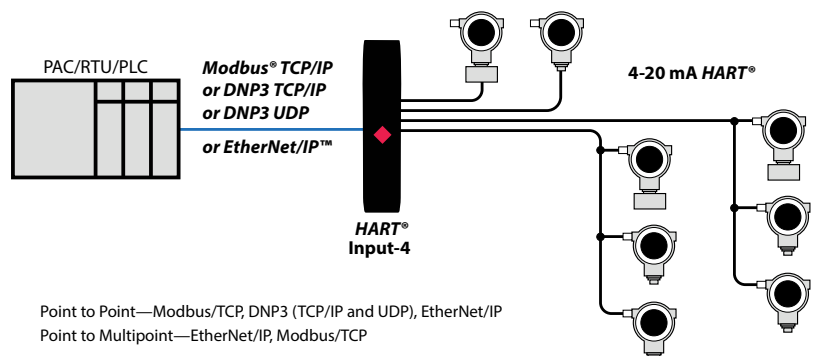

Find out how you'll benefit psft.com/DCB



Power and Energy Solutions

Connecting your Rockwell Automation controller to intelligent electronic devices (IEDs), including substation power monitors and relays.

Those devices' data can then be used for IED integration and substation automation, as well as be sent to the utility enterprise level. ProSoft has a variety of modules that can help you extend your power and energy application's Connected Enterprise.

IEC 61850 Solutions



IEC 61850 Client Module

- Allows ControlLogix® PACs to interface with IEC 61850 IEDs, including power protection equipment; features support for up to 40 IEC 61850 Server devices on the network
- Supports up to 225 I/O connections to ControlLogix PAC
- Supports MMS and GOOSE messaging, helping you eliminate hard-wired I/O signals for interlocking of protection relays and load shedding applications
- Streamlined configuration: Highly integrated into Studio 5000 with Add-On Profile; custom Add-On Instruction available
- An IEC 61850 Server Module is also available for ControlLogix PACs

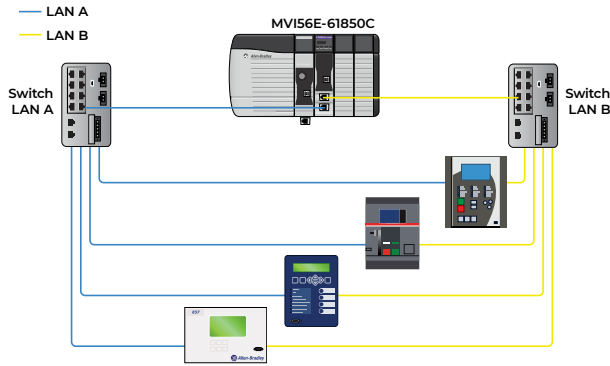

IEC 61850 Gateway

- Fast, real-time data transfers with a maximum of 10,000 bytes in and 9,920 out (PLX82)
- Polls up to 20 IEC 61850 server devices
- Application-specific Add-On Instructions are automatically generated
- IEC 61850 IED tags are created in your Studio 5000®/RSLogix 5000™ Project, reducing configuration time and errors

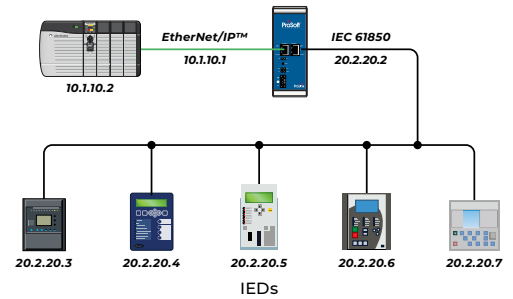

Other protocol solutions are available, including modules supporting IEC-60870-5-101/103/104, Modbus, PROFIBUS, and PROFINET.

DNP3 Solutions

Connect power and energy, oil and gas, or water and wastewater sites with industrial DNP3 solutions.

DNP3 Master and Slave Gateways



The PLX51-DNPM and -DNPS gateways enable intelligent routing between DNP3 and EtherNet/IP or Modbus protocols. Adding these modules into your SCADA and telemetry system will help you reliably capture key data with no holes, with time- and date-stamped data at the source.

- Supports secure authentication
- Optimized for Rockwell Automation architectures
- Flexible and easy to configure

PLX51-DNPM In Data Concentrator Mode with ProSoft PDN

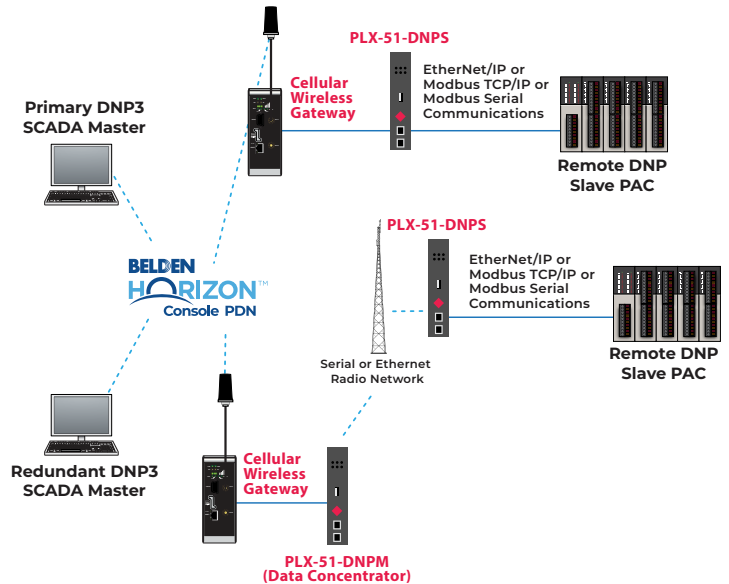



Modernization Solutions

Lower-risk, phased updates of legacy equipment can be completed on your timeline – without using up CapEx. Avoid extended downtime with this gradual approach.

Legacy Rockwell Automation Remote I/O and DH+™ Modernization Solutions

Modernize your legacy control system in phases with OpEx dollars



AN-X4-AB-DHRIO EtherNet/IP to Remote I/O or DH+ Gateway

- Replace old Remote I/O drives with new drives on EtherNet/IP without modifying PLC code
- Replace PanelView™ units on Remote I/O to new PanelView Plus 6 models on EtherNet/IP without modifying PLC code
- Enables your Remote I/O PLC-5® or SLC™ to communicate with EtherNet/IP FLEX™ I/O adapters, giving you a phased migration option when your 1794-ASB spares are gone

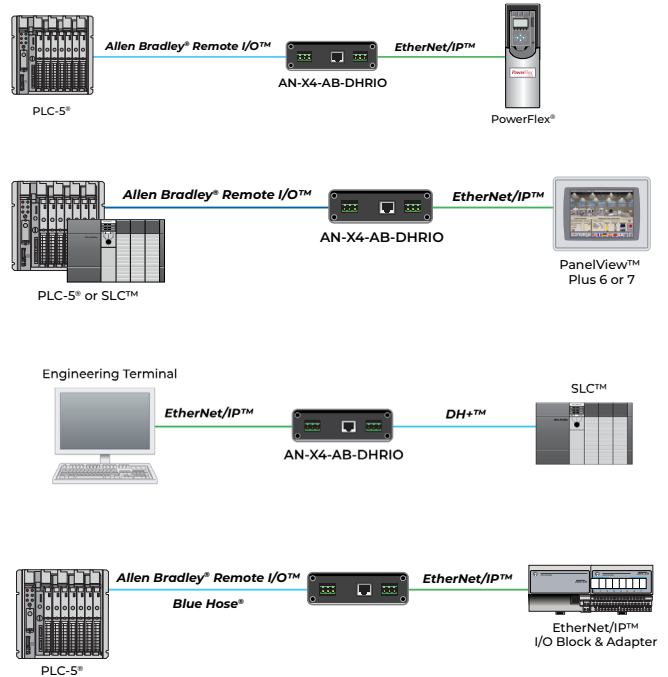

Legacy Competitive PLC Migration Solutions



AN-X3 Family of Gateways

- Enables Allen-Bradley PAC via EtherNet/IP to control I/O devices on legacy networks
- Enables a phase-based approach for migrating legacy control systems
- Monitor mode enables testing & verification of PAC logic before controlling I/O
- Currently available for AutoMax, Modicon, and GE Genius migrations

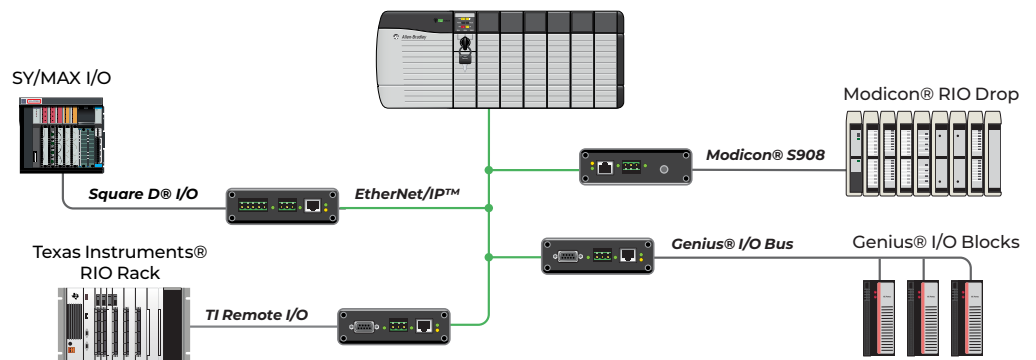

DCS migration solutions
psft.com/DB3

1761-NET-ENI Replacement – Update Your Legacy DFI Systems

Need a 1761-NET-ENI now that it's been discontinued? The Routing Module can be used in nearly every application as the NET-ENI. Now you can modernize your legacy DFI control system in phases using your OpEx budget.



- Intelligent routing to ControlLogix® or CompactLogix™ from PLC-5, SLC, MicroLogix™ controllers
- Direct-to-tag technology simplifies data mapping, reducing configuration time

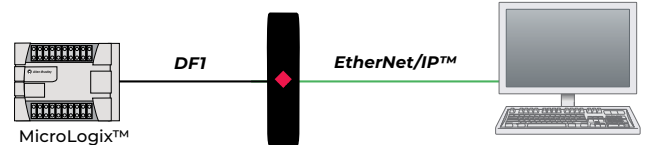

1761-NET-AIC Replacement – Update your legacy DH485 systems

Need a 1761-NET-AIC replacement? This module can be used in nearly every application as the NET-AIC. Now you can modernize your legacy DH485-based system in phases using your OpEx budget.



- Intelligent data routing between DH485 and EtherNet/IP devices
- Direct-to-tag technology simplifies data mapping, reducing configuration time
- 2-port unmanaged switch or Device Level Ring (DLR) support

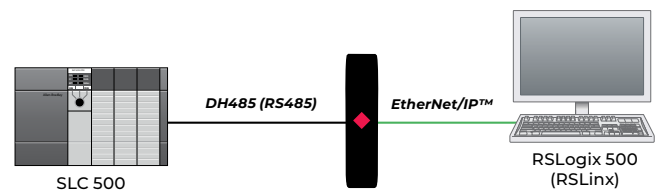

ControlNet and DeviceNet Modernizations



- **ControlNet Router:** Connect existing equipment to new EtherNet/IP-using PanelView Plus terminals – without having to do some major re-cabling. The module also supports Device Level Ring networks or can be used as a two-port Ethernet switch.



- **DeviceNet Router:** Allows you to exchange data between DeviceNet and EtherNet/IP networks. The router can be configured as a DeviceNet Scanner or a DeviceNet Device, which allows the device be integrated into a new Logix system while also allowing the EtherNet/IP device to be added to the DeviceNet network. The router also features two Ethernet ports to support Device Level Ring (DLR) applications.

Real-World Modernizations

American Castings estimates they saved over \$100,000 in lost production and implementation time, as well as 140 hours of troubleshooting and rewiring work. psft.com/DD5

Brains Brewery needed to upgrade its PLC-2® controllers - but only 3 days of downtime was available. The systems were updated, beer availability didn't skip a beat, and the process cost 40% less than an alternative modernization approach. psft.com/DD6



PROFIBUS Solutions

ProSoft's PROFIBUS DP modules are ideal for the most demanding applications.



For ControlLogix®

Through premier integration tools, you can minimize the time required to get a PROFIBUS DP network configured in a ControlLogix environment.

Master/multi-slave module: Can transfer up to 5000 bytes of cyclic I/O data with various slave devices on the network.

Multi-slave module: Can pass up to 2440 bytes of input and output data as high-speed cyclic I/O data on a PROFIBUS DP network.



For CompactLogix™

Master module: Supports remote Ethernet connectivity with Asset Management Software, significantly lowering your maintenance costs.

Slave module: Supports DPV1 Acyclic Messaging; Add-On Profile provided to allow for seamless integration to Studio 5000 and RSLogix 5000.

Gateways

Master and Slave gateways connect PROFIBUS DP equipment to devices using EtherNet/IP, Modbus Serial, or Modbus TCP/IP. PROFIBUS DP network commissioning time can be greatly reduced with the modules' built-in PROFIBUS DP packet capture utility. With support for up to 1536 bytes of Input and Output data, and up to 4 EtherNet/IP connections back to the processor, the modules provide performance and data throughput for even the most demanding of PROFIBUS applications.

Siemens® Communications and Migrations

Siemens Industrial Ethernet gateways can be used to foster connections between equipment using the protocol and EtherNet/IP or Modbus TCP/IP devices. ProSoft's modules include 2-port gateways that allow each protocol to reside on separate subnets, allowing you to pass data between the two subnets without changing each device's IP address. The gateways' Add-On Profiles allow for simplified integration and reduced commissioning time.

In-chassis modules are available to help you share data between your new Rockwell Automation controller and your existing Siemens Industrial Ethernet PLC.

PROFINET Gateways

- PROFINET Controller and Device Gateways connect to EtherNet/IP-based systems.
- Gateways with two Ethernet ports allow you to isolate networks, passing only the data you want between devices
- EtherNet/IP gateways support multiple I/O connections for fast real-time data

Enterprise Connectivity

Linux Development Modules

Connect Your Logix Processor to ThingWorx or to a MQTT Broker

These edge-compute modules are ideal for custom algorithm applications, including the transfer of key operational data. The ControlLogix module's library has sample applications (complete with source code!) for ThingWorx®, Sparkplug B MQTT, and standard MQTT. These samples help enable direct connectivity, expanding your IIoT application.

- In-chassis modules simplify your site and bring data directly into your ControlLogix or CompactLogix; help minimize cabinet space
- Linux Virtual Machine (VM) and C/C++ development environment provided on separate DVD
- VM contains preinstalled toolchain and libraries

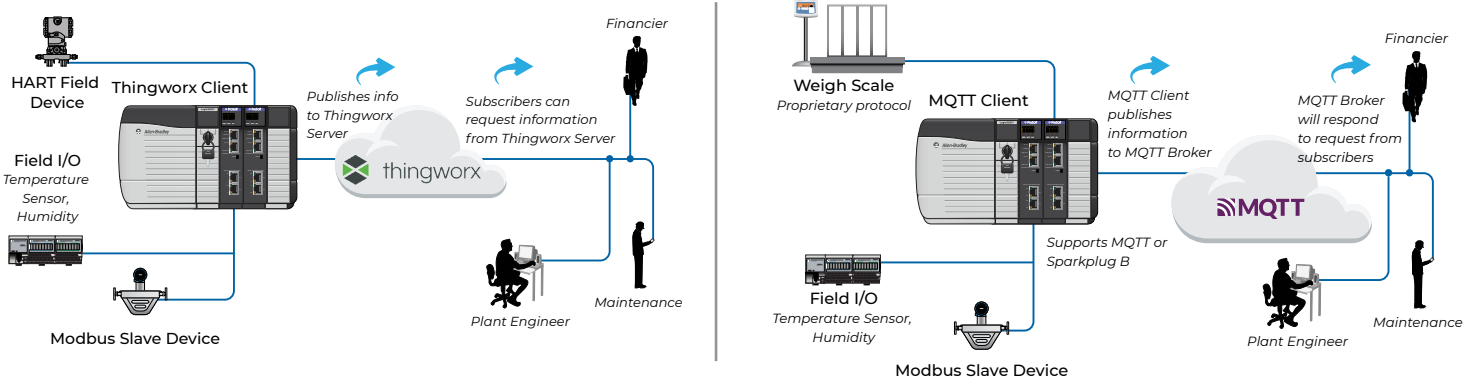

Leverage the IIoT

Collect, store, and analyze data to realize measurable business improvements.

There's operational data within nearly every piece of equipment in your application – and you can use it to make changes that will positively affect your facility. ProSoft's in-chassis modules and standalone gateways have been used for 30 years to connect disparate equipment, the first step on the path to showing ROI from your IIoT improvements.

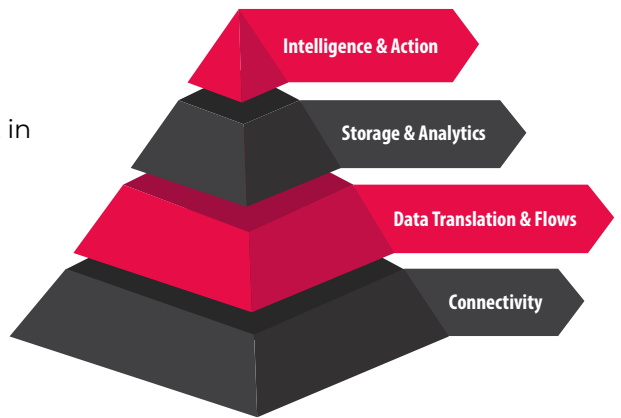

The best IIoT steps for your operation
psft.com/DB5



Automated Material Handling

Reliability is key for any Automated Material Handling application.

Industrial gateways and wireless radios enable communications between equipment in busy facilities, helping you maintain production and meet increased consumer demand.



Logistics

Increased consumer demand for goods bought online has heightened the need for reliable, on-time delivery of many household goods. Industrial protocol gateways and wireless radios can help ensure accurate production and distribution; real-time communications between moving equipment such as smart conveyors and automated guided vehicles (AGVs); and the safety of on-site employees in increasingly mobile applications.

Real-World Examples

A logistics end user needed to find a reliable alternative to slip rings for a conveyor application. Wireless radios now communicate with their CompactLogix.
psft.com/DEA

A perfume manufacturer produces its samples thanks to improved communication with their scale.
psft.com/DEB



Automotive

Automotive production is an intricate process whose automated elements rely on real-time communications.

Moving parts throughout a facility – whether they're half-finished vehicle frames moving down a production line or AGVs ferrying supplies – require reliable communications to protect workers and product throughout the site. Ultra-Fast Industrial Hotspots can help.

Real-World Examples

Fiat Chrysler increased production flexibility – and saved downtime – when they paired wireless radios with new Rockwell Automation controllers.
psft.com/DD4

A UK end user needed to transport materials within its automotive facility. The machine builder Mirage paired AGVs with wireless radios.
psft.com/DD9

Automotive Skillet Line Communication

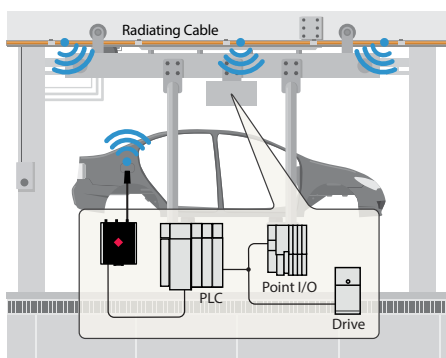

AGV Communication

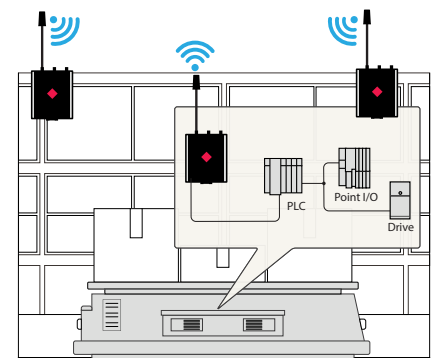



Amusement

At the top of any amusement end user or machine builder's mind is the need to maintain riders' safety.

Using wireless communications over CIP Safety helps increase communications for thrilling rides – as well as the safety of everyone on-board.

Real-World Examples

- Safety on the Skyfall: The company Funtime added radiating cable and a wireless radio to best monitor this freeride's signals.

psft.com/DEC

- Improvements to the Disk'O Coaster: Using a wireless Ethernet-based solution paired with a safety protocol helped this ride manufacturer improve the data rate of communication.

psft.com/DED

802.11n (abgn) Fast Industrial Hotspots

- Ultra-Fast access point switchover times of less than 10 ms are perfect for applications such as automated storage-retrieval systems, AGVs, and automotive skid lines
- EtherNet/IP™ embedded object and Modbus® agent support lets users get radio diagnostics into their
- PAC/PLC, where the information can be analyzed and acted upon, helping to reduce downtime
- WPA/WPA2-Personal (PSK, AES and/or TKIP); WPA/WPA2-Enterprise (IEEE 802.1X/RADIUS, AES and/or TKIP)
- Secure digital configuration storage for quick field replacement
- Radios support wireless safety Ethernet networks, ideal for automated material handling applications

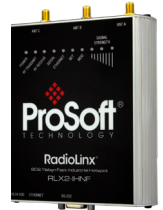

2.4 GHz and 5 GHz High-Power Industrial Hotspots are also available for longer-distance applications.

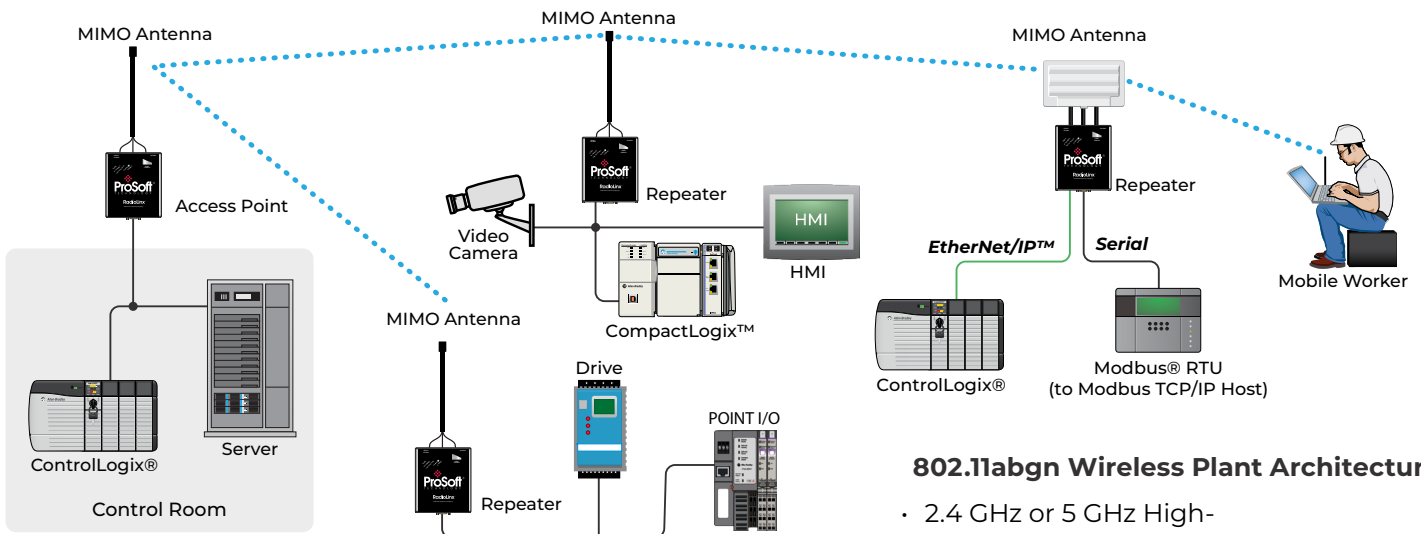

802.11abgn Wireless Plant Architecture

- 2.4 GHz or 5 GHz High-Speed Wireless Network

Radiating Cable 2.4 and 5 GHz Band

Acting as a long, flexible antenna, Radiating Cable is an alternative to traditional RF antenna systems.

Features

- Special coaxial shield design uses slots to radiate RF Signals
- Available in variable lengths
- Pre-assembled cable for easy installation
- Frequency Range: 2.4 GHz, 5 GHz to 6 GHz

Benefits

- Wireless signal more stable in terms of response time – useful in communicating with I/O
- Used in metallic environments, rotating/spinning machines, conveyors, AGVs, warehousing, and more

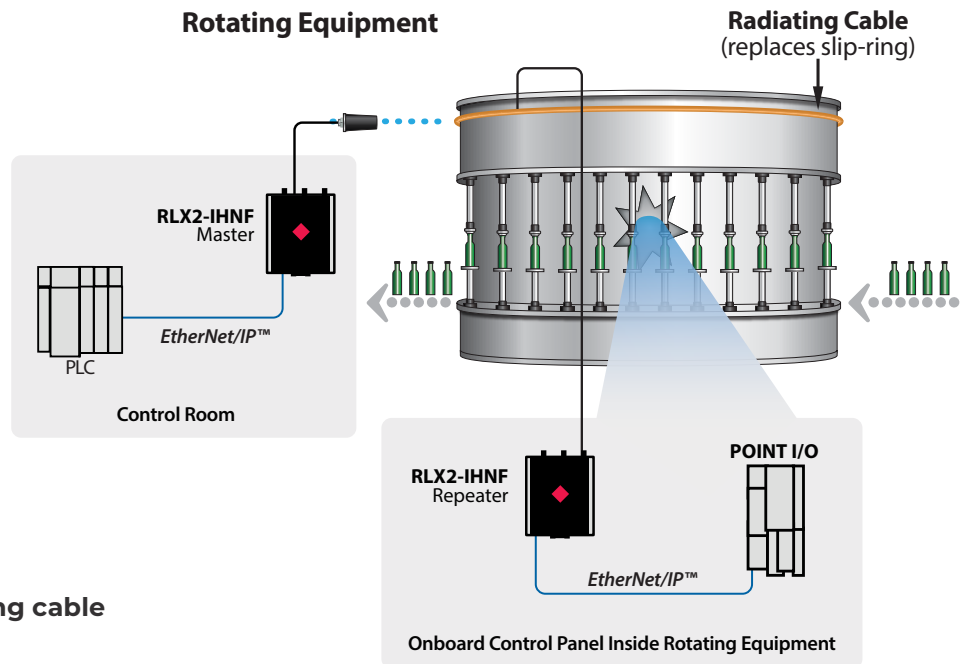

How you'll benefit from radiating cable
psft.com/CXL

802.11n (abgn) Fast Watertight Industrial Hotspots

- IP67 water/dust-rated
- Designed for extreme temperatures (-40° to +70°C), high vibration/shock and hazardous locations (UL CID2, ATEX Zone 2)
- Ultra-Fast Roaming with under 10 ms switchover times maintains connections for moving machines/platforms
- Power over Ethernet (PoE)
- QoS and VLAN for optimum traffic management
- WPA/WPA2-Personal (PSK, AES and/or TKIP)
- WPA/WPA2-Enterprise (IEEE 802.1X/ RADIUS, AES and/or TKIP)

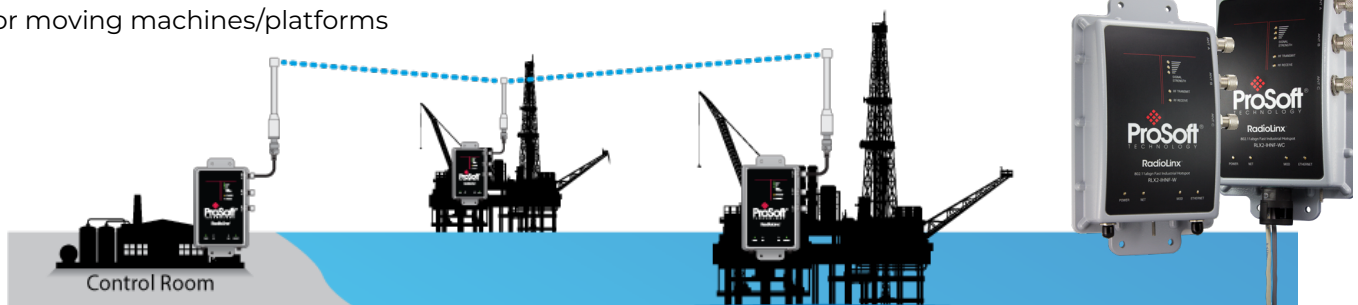

Wireless Support from Trusted Experts

Designing and implementing a wireless network is a major investment. ProSoft's wireless field application engineers can help ensure a smooth design and installation for your application. Our professional wireless services include:

- Expert Phone Support
- Engineering Drawing Review
- Site Surveys
- Configuration Support
- Troubleshooting



Contact us at psft.com/DD8 to learn more.

Wireless Application Guide:

In this comprehensive resource, find out the key considerations for adding wireless communications over CIP Safety.

psft.com/DD7

Wireless Comparison Product Selection Chart

Model	802.11abgn Weatherproof Industrial Hotspot	802.11abgn Fast Industrial Hotspot	Industrial Cellular Gateway
	RLX2-IHNF-W(C)	RLX2-IHNF	ICX35-HWC
Features & Specifications			
Device Connectivity	Ethernet	Ethernet/Serial	Ethernet/Serial
Frequency Band(s)	2.4 & 5 GHz	2.4 & 5 GHz	Cellular
Regions Unlicensed Use Allowed	Global	Global	Global
Wireless Technology	IEEE 802.11abgn	IEEE 802.11abgn	4G LTE Cellular HSPA
Max Outdoor Range (miles/km)	5 mi / 8 km	5 mi / 8 km	Unlimited
Fast Roaming	Yes	Yes	N/A
Repeater Mode	Yes	Yes	N/A
Max RF Data Rate	300 Mbps	300 Mbps	N/A
Security/Encryption	802.11i / 128 bit AES	802.11i / 128 bit AES	Internal Firewall, Belden Horizon VPN, OpenVPN, IPSec
RF Based IGMP Querying	Yes	Yes	N/A
Self-Healing Network	Yes	Yes	N/A
Advanced Diagnostics (signal strength LEDs, web server, network management software, OPC tag server, SNMP)	Yes	Yes	N/A
Hazardous Location Approvals	Class 1, Div 2/ Atex Zone 2 (WC)	Class 1, Div 2/ Atex Zone 2	Class 1, Div 2
Outdoor/Wash Down Rated Model	IP67	N/A	N/A
Wireless Applications			
Long-Range SCADA	N/A	N/A	Yes
Short-Range SCADA	Yes	Yes	Yes
Mobile Worker (Wi-Fi)	Yes	Yes	N/A
EtherNet/IP™ Object	Yes	Yes	Yes
EtherNet/IP™ Implicit Messaging (High-Speed IO)	Yes	Yes	N/A
Serial DF1, ASCII, Modbus®, DNP3, etc.	N/A	Yes (encapsulation)	Yes (encapsulation)
Video	Fast Frame Rate	Fast Frame Rate	Yes
Check for product availability in your country.			

In-Chassis Product Selection Chart

Platform	ControlLogix [®]	CompactLogix [™]	Point I/O
Protocol/Application			
AGA/API Gas & Liquid Flow Computer	MVI56E-AFC	MVI69E-AFC	
Moore APACS+ I/O			
ASCII	MVI56E-GSC MVI56E-GSCXT	MVI69E-GSC	
BASIC			
'C' Programmable	MVI56E-LDM	MVI69E-LDM	
DF1	PLX51-DF1-ENI	PLX51-DF1-ENI	
DNP3 Serial			
DNP3 Ethernet		MVI69-DNPSNET	
EtherNet/IP [™]			
FA Control/Network	MVI56E-FLN		
GE Ethernet Global Data	MVI56-EGD		
Generic Ethernet ASCII	MVI56E-GEC	MVI69E-GEC	
IEC 60870-5-101 Slave			
IEC 60870-5-101 Master			
IEC 60870-5-104 Server			
IEC 61850 Client	MVI56E-61850C		
IEC 61850 Server	MVI56E-61850S		
Limitorque Master			
Modbus [®] Serial	MVI56E-MCM MVI56E-MCMR MVI56E-MCMXT	MVI69E-MBS MVI69L-MBS	ILX34-MBS232 ILX34-MBS485
Modbus [®] TCP/IP	MVI56E-MNET MVI56E-MNETC MVI56E-MNETR MVI56E-MNETCR MVI56E-MNETXT	MVI69E-MBTCP MVI69L-MBTCP	
PROFIBUS DP Master	ILX56-PBM	ILX69-PBM	
PROFIBUS DP Slave	ILX56-PBS	ILX69-PBS	
Siemens [®] 3964R			
Siemens [®] Industrial Ethernet	MVI56E-SIE		

Have a legacy product that's no longer on these charts?

ProSoft can help you migrate to a newer solution with expanded functionality.

Learn more about solutions for legacy controllers at psft.com or by contacting your local ProSoft office.

Many of ProSoft's in-chassis and gateway modules for Rockwell Automation systems feature Add-On Instructions or Add-On Profiles to help you increase efficiency and reduce configuration.

Learn more: psft.com/DCC

Stand-Alone Gateways Product Selection Chart

Protocol/Application												
Application/Protocol	ASCII	DF1 Master/Slave	DNP 3.0 (Serial + Ethernet)	EtherNet/IP™	HART Multidrop/Analog (4 chnl)	IEC 60870-5-104 Server	Modbus® Serial	Modbus® TCP/IP	OPC UA	PROFIBUS DP Master	PROFIBUS DP Slave	PROFINET
ASCII				PLX31-EP-ASCII PLX31-EP-ASCII4				Contact support				
BACnet® /IP, BACnet® MS/TP				PS-OS-2010-F (250 Pt) PS-OS-2210-F (500 Pt) PS-OS-3010-F (250 Pt) PS-OS-3110-F (500 Pt) PS-OS-3210-F (1000 Pt)			PS-OS-2010-F (250 Pt) PS-OS-2210-F (500 Pt) PS-OS-3010-F (250 Pt) PS-OS-3110-F (500 Pt) PS-OS-3210-F (1000 Pt)					
DF1 Master/Slave		Contact support PLX51-DL-232 PLX51-DLplus-232		PLX51-DF1-ENI PLX51-DF1-MSG			Contact support	Contact support			Contact support	
DH485				A-DH485RB								
DNP 3.0 (Serial + Ethernet)				PLX51-DNPM PLX51-DNPS	PLX51-HART-4I (4 channel)		PLX51-DNPM PLX51-DNPS	PLX51-DNPM PLX51-DNPS			Contact support	
EtherNet/IP™	PLX31-EP-ASCII PLX31-EP-ASCII4	PLX51-DF1-ENI PLX51-DF1-MSG	PLX51-DNPM PLX51-DNPS	PLX35-NB2	PLX51-HART-4I (4 channel) PLX51-HART-4O	PLX32-EP-104	PLX31-EP-MBS PLX31-EP-MBS4 A-MBR/B	PLX31-EP-MBTCP PLX32-EP-MBTCP-UA A-XGPS A-MBR/B	PLX32-EP-MBTCP-UA	PLX51-PBIM	PLX51-PBS	PLX31-EP-PND PLX32-EP-PND PLX82-EP-PNC
HART® Analog				PLX51-HART-4I PLX51-HART-4O				PLX51-HART-4I PLX51-HART-4O				
HART® Multi-drop				PLX51-HART-4I (4 channel) PLX51-HART-4O				PLX51-HART-4I PLX51-HART-4O				
IEC 60870-5-104 Server				PLX32-EP-104				PLX32-MBTCP-104				
IEC 61850™				PLX82-EP-61850				PLX82-MNET-61850				
LonWorks™				PS-OS-1011-F (250 Pt) PS-OS-1211-F (500 Pt)			PS-OS-1011-F (250 Pt) PS-OS-1511-F (500 Pt)	PS-OS-1011-F (250 Pt) PS-OS-1511-F (500 Pt)				
Modbus® N2				PS-OS-2010-F (250 Pt) PS-OS-2210-F (500 Pt) PS-OS-3010-F (250 Pt) PS-OS-3110-F (500 Pt) PS-OS-3210-F (1000 Pt)			PS-OS-2010-F (250 Pt) PS-OS-2210-F (500 Pt) PS-OS-3010-F (250 Pt) PS-OS-3110-F (500 Pt) PS-OS-3210-F (1000 Pt)	PS-OS-2010-F (250 Pt) PS-OS-2210-F (500 Pt) PS-OS-3010-F (250 Pt) PS-OS-3110-F (500 Pt) PS-OS-3210-F (1000 Pt)				
Modbus® Serial				PLX31-EP-MBS PLX31-EP-MBS4 A-MBR/B	Contact support		Contact support	Contact support		PLX51-PBIM	PLX51-PBS	PLX31-PND-MBS PLX31-PND-MBS4
Modbus® TCP/IP	Contact support			PLX31-EP-MBTCP PLX32-EP-MBTCP-UA A-XGPS A-MBR/B	PLX51-HART-4O PLX51-HART-4I	PLX32-MBTCP-104		PLX32-EP-MBTCP-UA PLX51-PBIM PLX51-PBS	PLX32-EP-MBTCP-UA	PLX51-PBIM	PLX51-PBS	PLX31-MBTCP-PND PLX32-MBTCP-PND PLX82-MBTCP-PNC
OPC UA				PLX32-EP-MBTCP-UA				PLX32-EP-MBTCP-UA				
PROFIBUS DP				PLX51-PBIM PLX51-PBS			PLX51-PBIM PLX51-PBS	PLX51-PBIM PLX51-PBS				
PROFIBUS PA				A-PAL/B				A-PAL/B				
PROFINET				PLX31-EP-PND PLX32-EP-PND PLX82-EP-PNC			PLX31-PND-MBS PLX31-PND-MBS4	PLX31-MBTCP-PND PLX32-MBTCP-PND PLX82-MBTCP-PNC				
Siemens® Industrial Ethernet				PLX31-EP-SIE PLX32-EP-SIE				PLX31-MBTCP-SIE PLX32-MBTCP-SIE				
CAN Protocols (CAN Open, DeviceNet, J1939)				A-CANORB A-DNTR/B A-J1939/B				A-CANORB				
ControlNet				A-CNR								
PTP/MT/PT				A-TSM/B								
Data Logging				PLX51-DL-232 PLX51-DLplus-232			PLX51-DL-232 PLX51-DLplus-232	PLX51-DL-232 PLX51-DLplus-232				
FOUNDATION Fieldbus				A-FFL/B				A-FFL/B				

Asia Pacific

Regional Office

Phone: +603.2242.2020
asiapc@prosoft-technology.com
Languages: Bahasa, Chinese, English, Japanese, Korean

Regional Tech Support

support.ap@prosoft-technology.com

North Asia (China, Hong Kong)

Phone: +86.21.5187.7337
china@prosoft-technology.com
Languages: Chinese, English

Southwest Asia

(India, Pakistan, Sri Lanka, Bangladesh, Mongolia)

Phone: +91.99.1008.6221
india@prosoft-technology.com
Languages: English, Hindi

Australasia

(Australia, N. Zealand)

Phone: +61.491.095.248
pacific@prosoft-technology.com
Language: English

Southeast Asia

(Singapore, Indonesia, Philippines, Thailand, Vietnam, Malaysia, Myanmar, Cambodia, Laos, Vietnam)

Phone: +60.12.275.3307
seasia@prosoft-technology.com
Languages: English, Bahasa, Malay

Northeast & Southeast Asia (Japan, Taiwan)

Phone: +60.12.275.3307
neasia@prosoft-technology.com
Languages: English, Chinese, Japanese

Korea

Phone: +82.10.7187.2064
korea@prosoft-technology.com
Languages: English, Korean

Europe / M. East / Africa

Regional Office

Phone: +33.(0)5.34.36.87.20
europe@prosoft-technology.com
Languages: French, English

Regional Tech Support

support.emea@prosoft-technology.com

Middle East, Turkey, Sub-Saharan Africa

Phone: +971.4.214.6911
mea@prosoft-technology.com
Languages: Hindi, English

North Western Europe (UK, IE, IS, DK, NO, SE)

Phone: +44.(0)7415.864.902
nweurope@prosoft-technology.com
Language: English

Austria, Germany, Switzerland

Phone: +32.474.36.84.51
germany@prosoft-technology.com
Languages: French, English, Dutch

France, Benelux, Portugal, Algeria, Morocco, Tunisia

Phone: +32.474.36.84.51
france@prosoft-technology.com
Languages: French, English, Dutch

Italy, Greece, Israel, Eastern Europe

Phone: +39.342.8651.595
italy@prosoft-technology.com
Languages: Italian, English

Latin America

Regional Office

Phone: +52.222.264.1814
latinam@prosoft-technology.com
Languages: Spanish, English

Regional Tech Support

support.la@prosoft-technology.com

Argentina, Bolivia, Brazil, Paraguay, Uruguay

Phone: +55.11.5084.5178
brasil@prosoft-technology.com
Languages: Portuguese, English

Mexico, Andean, Caribbean, & Central America (VE, CO, PE, EC)

Phone: +507-6427-48-38
mexico@prosoft-technology.com
Languages: Spanish, English

North America

Regional Office

Phone: +1.661.716.5100
info@prosoft-technology.com
Languages: English, Spanish

Regional Tech Support

support@prosoft-technology.com



Support and expertise for your projects

ProSoft provides a variety of resources and services for wireless applications from initial system design to site surveys to launch support and configuration support.

Tech Support: support@prosoft-technology.com

Contact Us



Copyright ©2024 ProSoft Technology, Inc.

All Rights Reserved. June 2024

Rockwell_2024_EN1

ProSoft[®]
TECHNOLOGY

www.psft.com