

Where Automation Connects.



PLX51-DNPS

DNP3 Slave / Outstation
Communications Gateway with SAV5

May 22, 2023

Your Feedback Please

We always want you to feel that you made the right decision to use our products. If you have suggestions, comments, compliments or complaints about our products, documentation, or support, please write or call us.

ProSoft Technology, Inc.

+1 (661) 716-5100

+1 (661) 716-5101 (Fax)

www.prosoft-technology.com

support@prosoft-technology.com

PLX51-DNPS User Manual

For Public Use.

May 22, 2023

ProSoft Technology®, is a registered copyright of ProSoft Technology, Inc. All other brand or product names are or may be trademarks of, and are used to identify products and services of, their respective owners.

In an effort to conserve paper, ProSoft Technology no longer includes printed manuals with our product shipments. User Manuals, Datasheets, Sample Ladder Files, and Configuration Files are provided at our website: www.prosoft-technology.com

Content Disclaimer

This documentation is not intended as a substitute for and is not to be used for determining suitability or reliability of these products for specific user applications. It is the duty of any such user or integrator to perform the appropriate and complete risk analysis, evaluation and testing of the products with respect to the relevant specific application or use thereof. Neither ProSoft Technology nor any of its affiliates or subsidiaries shall be responsible or liable for misuse of the information contained herein. Information in this document including illustrations, specifications and dimensions may contain technical inaccuracies or typographical errors. ProSoft Technology makes no warranty or representation as to its accuracy and assumes no liability for and reserves the right to correct such inaccuracies or errors at any time without notice. If you have any suggestions for improvements or amendments or have found errors in this publication, please notify us.

No part of this document may be reproduced in any form or by any means, electronic or mechanical, including photocopying, without express written permission of ProSoft Technology. All pertinent state, regional, and local safety regulations must be observed when installing and using this product. For reasons of safety and to help ensure compliance with documented system data, only the manufacturer should perform repairs to components. When devices are used for applications with technical safety requirements, the relevant instructions must be followed. Failure to use ProSoft Technology software or approved software with our hardware products may result in injury, harm, or improper operating results. Failure to observe this information can result in injury or equipment damage.

© 2023 ProSoft Technology. All Rights Reserved.



For professional users in the European Union

If you wish to discard electrical and electronic equipment (EEE), please contact your dealer or supplier for further information.



Warning – Cancer and Reproductive Harm – www.P65Warnings.ca.gov

Agency Approvals and Certifications

Please visit our website: www.prosoft-technology.com

Contents

Your Feedback Please	2
Content Disclaimer	2
Agency Approvals and Certifications.....	2
1 Preface	6
1.1 Introduction to the PLX51-DNPS	6
1.2 Features	7
1.3 Architecture.....	8
1.4 Additional Information	9
1.5 Support	9
2 Installation	10
2.1 Module Layout	10
2.2 Module Mounting	12
2.3 Power	13
2.4 RS232/RS485 Port	13
2.5 RS485 Termination.....	14
2.6 Ethernet Ports	14
2.7 USB Port	14
3 Setup	15
3.1 Install Configuration Software.....	15
3.2 Network Parameters	15
3.3 Creating a New Project.....	20
3.4 PLX51-DNPS Configuration	22
3.4.1 General	22
3.4.2 Communication	23
3.4.3 Modbus	24
3.4.4 DNP3	26
3.4.5 Security	28
3.4.6 Outstation Settings	30
3.4.7 Outstation Events	32
3.4.8 Outstation Repeater.....	33
3.4.9 Modbus Map	34
3.4.10 Advanced.....	35
3.5 Message Routing.....	36
3.5.1 Outstation Map.....	36
3.6 DNP3 Events	50
3.7 Outstation Repeaters.....	52
3.8 Module Download	54
3.9 RSLogix 5000 Configuration.....	56
3.9.1 Studio 5000 Configuration (Version 20+)	56
3.9.2 RSLogix 5000 Configuration (Pre-Version 20)	62
4 microSD Card	66
4.1 Firmware	67
4.2 Configuration.....	67
4.2.1 Manual Copy.....	68
4.2.2 PLX50CU Upload	69

5	Logix Operation	70
5.1	Message Routing	70
5.2	RSLogix 5000 assemblies	70
5.2.1	Input Assembly	70
5.2.2	Output Assembly	71
6	DNP3 Operation	72
6.1	General	72
6.1.1	EtherNet/IP	72
6.1.2	Modbus	75
6.2	Analog/Binary Output Commands	76
6.2.1	EtherNet/IP	77
6.2.2	Modbus	78
6.3	Counter Freeze Commands	80
6.3.1	EtherNet/IP	80
6.3.2	Modbus	81
6.4	DNP3 Events and Unsolicited Responses	83
6.4.1	Outstation Event Configuration	83
6.5	Report-By-Exception	85
6.6	Outstation Time Needed	86
6.7	Dual DNP3 Master Event Unloading	88
6.8	Outstation Local Time Update	89
7	Modbus Operation	92
7.1	Message Routing	92
7.2	DNP Status	92
7.3	DNP Information	93
8	DNP3 Dynamic Configuration	94
8.1	Assign Classes	95
8.2	Written Analog Deadbands	97
8.3	Enabled/Disabled Unsolicited Responses	99
9	Security	101
9.1	Key Updates	102
9.1.1	Local Key Update	102
9.1.2	Remote Key Update	105
10	Diagnostics	108
10.1	LEDs	108
10.2	Module Status Monitoring in PLX50 Configuration Utility	109
10.2.1	General	110
10.2.2	DNP3 Statistics	112
10.2.3	Logix Statistics	114
10.2.4	Modbus Statistics	115
10.2.5	Security Statistics	116
10.2.6	Map Items	117
10.2.7	Event Statistics	118
10.2.8	Unsolicited Events	119
10.2.9	Repeater Statistics	120
10.2.10	CIP Statistics	121
10.2.11	USB Statistics	122
10.2.12	Ethernet Clients	123

10.2.13	TCP / ARP Tables	124
10.3	DNP3 Packet Capture	125
10.4	Module Event Log	127
10.5	Web Server	128
11	Technical Specifications	129
<hr/>		
11.1	Dimensions	129
11.2	Electrical	130
11.3	Environmental	130
11.4	Ethernet	130
11.5	Serial Port (RS232).....	131
11.6	Serial Port (RS485).....	131
11.7	USB Port.....	131
11.8	DNP3	132
11.9	DNP3 Secure Authentication	133
12	Appendix A - DNP3 Reference	134
<hr/>		
12.1	DNP3 Functions.....	134
12.2	DNP3 Groups.....	135
12.3	Supported DNP3 Group Variations	136
12.4	DNP3 Qualifier Code	138
12.5	DNP3 Event Status Flags	140
12.6	DNP3 Control Relay Output Block (CROB)	141
13	Appendix B - CIP Object Reference	142
<hr/>		
13.1	General Status	142
13.2	Time Status.....	143
13.3	DNP3 Statistics	144
13.4	DNP3 Event Statistics.....	146
13.5	DNP3 Tag Mapping Statistics.....	148
14	Support, Service & Warranty	149
<hr/>		
14.1	Contacting Technical Support.....	149
14.2	Warranty Information	149

1 Preface

1.1 Introduction to the PLX51-DNPS

This manual describes the installation, operation, and diagnostics of the ProSoft Technology PLX51-DNPS module. This module provides intelligent data routing between DNP3 (serial, Ethernet UDP, or Ethernet TCP) and either EtherNet/IP or Modbus (TCP/IP or RTU). The PLX51-DNPS allows you to integrate DNP3 devices over a secure link into a Rockwell Logix platform (e.g. ControlLogix or CompactLogix) with minimal effort.

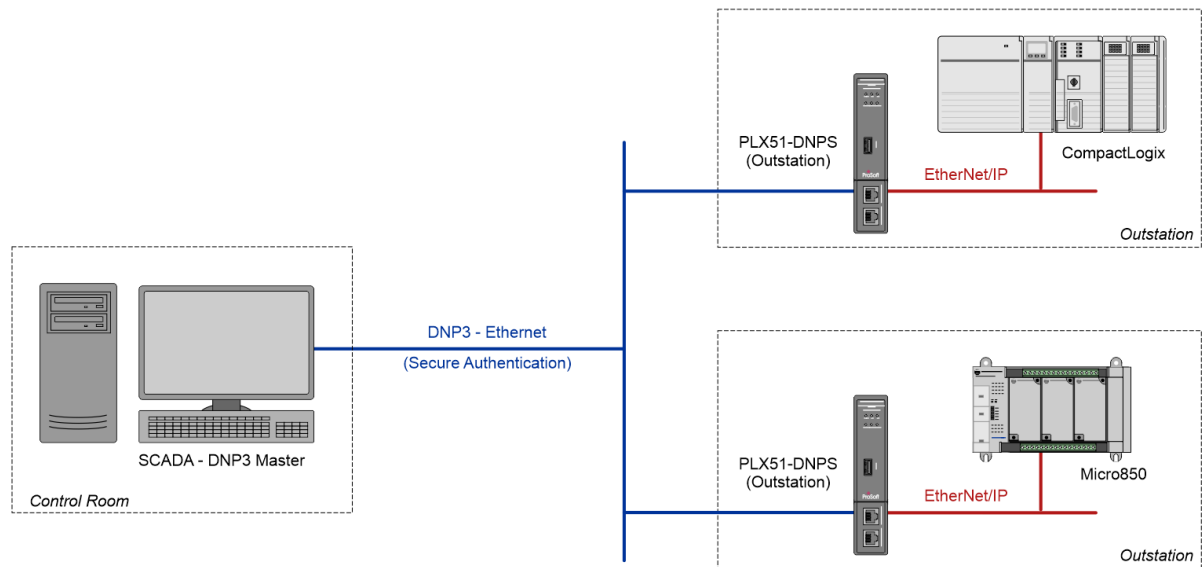

Figure 1.1 – Typical setup

1.2 Features

The PLX51-DNPS is able to transfer data from various DNP3 devices to a maximum of three Logix controllers when using EtherNet/IP.

Module	Mode	Description	Message Initiator
PLX51-DNPS	Outstation	The PLX51-DNPS will convert DNP3 messages to Logix controller tag or Modbus reads or tag actions.	Remote Master

Table 1.1 – Modes of operation

The PLX51-DNPS is configured using the ProSoft Technology PLX50 Configuration Utility. This software can be downloaded at www.prosoft-technology.com, free of charge. The PLX50 Configuration Utility offers various configuration methods, including a controller tag browser.

In this document the PLX51-DNPS is also referred to as the **module**.

When the **Operating Interface** is configured for EtherNet/IP, the module can operate in both a Logix “owned” and standalone mode. With a Logix connection the input and output assemblies will provide additional diagnostics information which will be available in the Logix controller environment.

The PLX51-DNPS allows you to integrate DNP3 devices into a Logix system with minimal effort. No copying or mapping of data in the Logix controller is required as the PLX51-DNPS writes directly into Logix tags.

When the **Operating Interface** is configured for one of the Modbus options the module can exchange DNP3 data with any Modbus device, operating in either a Modbus Master or Modbus Slave capacity.

The PLX51-DNPS module also provides DNP3 Secure Authentication 5, which enables you to connect DNP3 devices to a Logix platform securely. The module also provides a range of diagnostics, statistics and a DNP3 traffic analyzer to assist with fault-finding.

The PLX51-DNPS supports DNP3 on three ports, which can be configured from the PLX50 Configuration Utility: RS232, RS485 and Ethernet (TCP or UDP).

Previously complicated data mapping is made easy by precompiled UDTs which converts the various DNP3 data formats into meaningful data in the Logix environment.

The PLX51-DNPS also supports repeater functionality in Outstation mode, allowing you to have infield configurable repeaters in radio network applications.

The module’s serial ports (both RS232 and RS485) are electrically isolated providing better noise immunity. Their connections use a terminal block for convenient installation.

A built-in webserver provides detailed diagnostics of system configuration and operation, including the display of DNP3 operation and communication statistics, without the need for any additional software.

1.3 Architecture

The figure below provides an example of a typical PLX51-DNPS network setup.

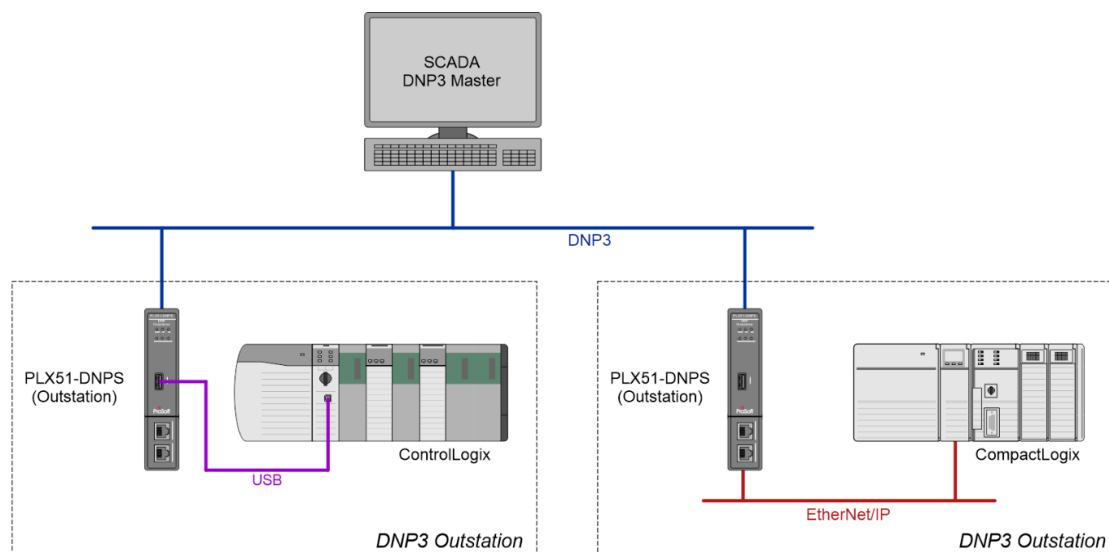

Figure 1.2 - Example of a typical network setup in Outstation mode

By converting and redirecting serial DNP3 messages from legacy devices to EtherNet/IP, the module provides an interface for data exchange to Allen-Bradley ControlLogix and CompactLogix platforms. This enables user to replace legacy devices and systems with minimal effort and downtime.

The PLX51-DNPS allows a Logix platform to seamlessly integrate into a DNP3 network. The module will route DNP3 message directly to Logix tags with no need for additional ladder code.

The PLX51-DNPS provides the latest DNP3 Secure Authentication 5 standard which allows for secure authentication across the DNP3 network (Serial or Ethernet). The need for network security is essential to utility installations and operations to prevent unwanted attacks from outsiders. The PLX51-DNPS allows you to configure the type and level of security needed with minimal effort.

The PLX51-DNPS allows you to implement repeaters into a radio network architecture when the DNP3 master cannot see all the outstations (see below). The PLX51-DNPS can be configured to repeat certain messages as well as route messages to other PLX51-DNPS's via Ethernet.

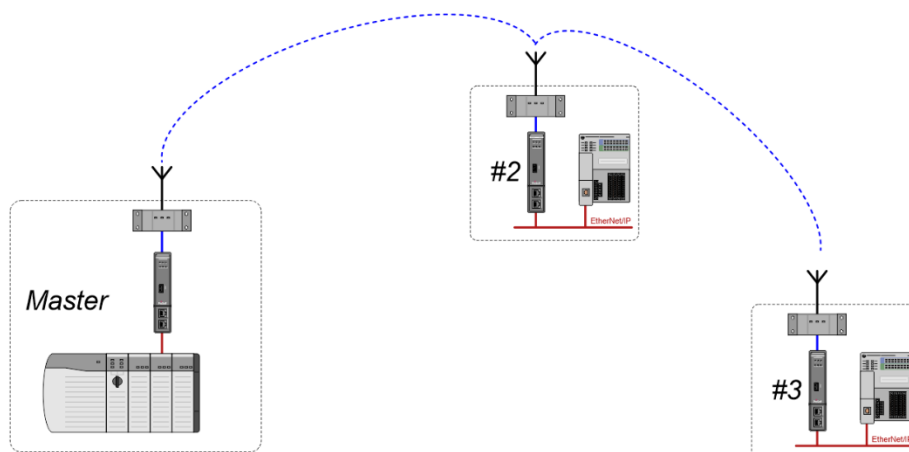

Figure 1.3 – Example of using the PLX51-DNPS as a repeater

1.4 Additional Information

The following documents contain additional information that can assist you with the module installation and operation.

Resource	Link
PLX50 Configuration Utility Installation	www.prosoft-technology.com
PLX51-DNPS User Manual PLX51-DNPS Datasheet Example Code & UDTs	www.prosoft-technology.com
Ethernet wiring standard	www.cisco.com/c/en/us/td/docs/video/cds/cde/cde205_220_420/installation/guide/cde205_220_420_hig/Connectors.html
CIP Routing	The CIP Networks Library, Volume 1, Appendix C:Data Management
DNP3	http://www.dnp.org

Table 1.2 - Additional information

1.5 Support

Technical support is provided via the Web (in the form of user manuals, FAQ, datasheets etc.) to assist with installation, operation, and diagnostics.

Resource	Link
Contact Us web link	www.prosoft-technology.com
Support email	support@psft.com

Table 1.3 – Support details

2 Installation

2.1 Module Layout

The PLX51-DNPS module has two Ethernet ports located at the lower front of the module. The Ethernet cable must be wired according to industry standards, which can be found in the [“Additional Information”](#) section.

There are also two ports at the bottom of the module for Power and Serial communication (RS232 and RS485).

The power port uses a three-way connector which is used for the DC power supply positive and negative (or ground) rails as well as the earth connection.

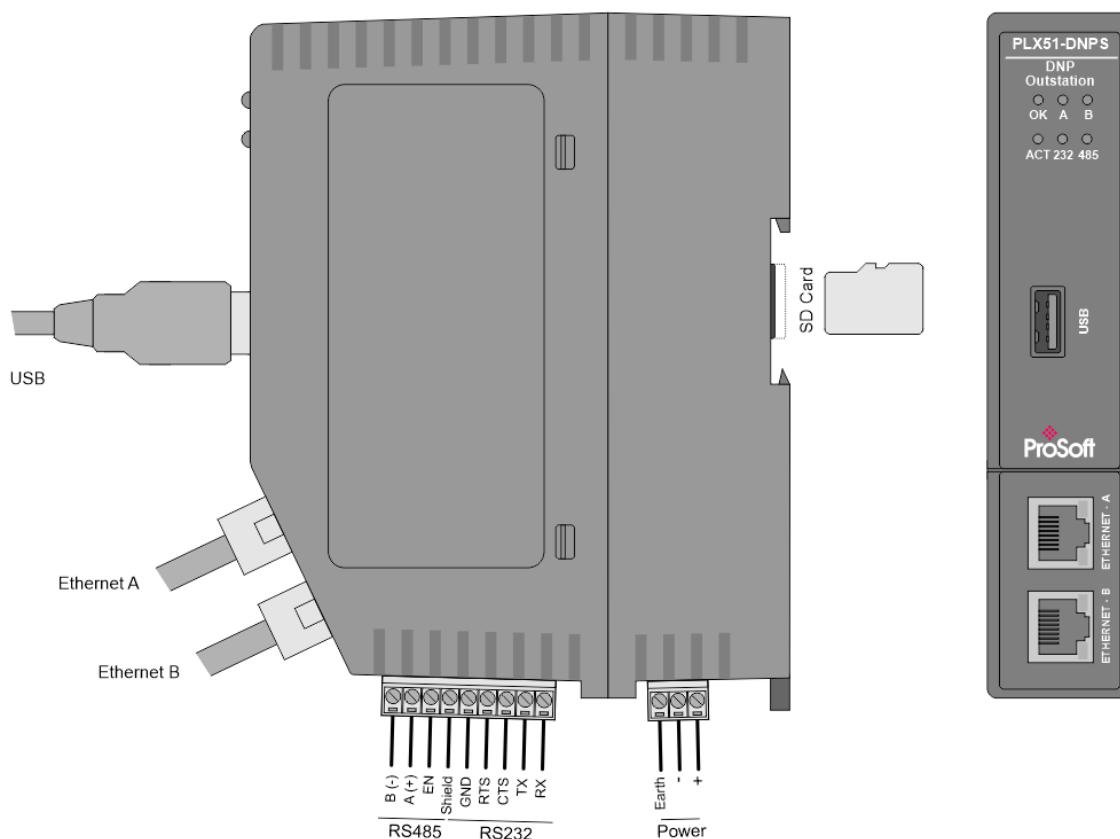

Figure 2.1 – PLX51-DNPS side and front view

The module provides six diagnostic LEDs as shown in the front view figure above. These LEDs are used to provide information regarding the module system operation, the Ethernet interface, and the auxiliary communication interface (RS232 or RS485).



Figure 2.2 – PLX51-DNPS top view

The module provides four DIP switches at the top of the enclosure as shown in the top view figure above.

DIP Switch	Description
DIP Switch 1	Used to force the module into “Safe Mode”. When in “Safe Mode” the module will not load the application firmware and will wait for new firmware to be downloaded. This should only be used in the rare occasion when a firmware update was interrupted at a critical stage.
DIP Switch 2	This will force the module into DHCP mode which is useful when you have forgotten the IP address of the module.
DIP Switch 3	This DIP Switch is used to lock the configuration from being overwritten by the PLX50 Configuration Utility.
DIP Switch 4	When this DIP Switch is set at bootup it will force the module Ethernet IP address to 192.168.1.100 and network mask 255.255.255.0. You can then switch the DIP switch off and assign the module a static IP address if needed.

Table 2.1 - DIP switch settings

2.2 Module Mounting

The module provides a DIN rail clip to mount onto a 35mm DIN rail.

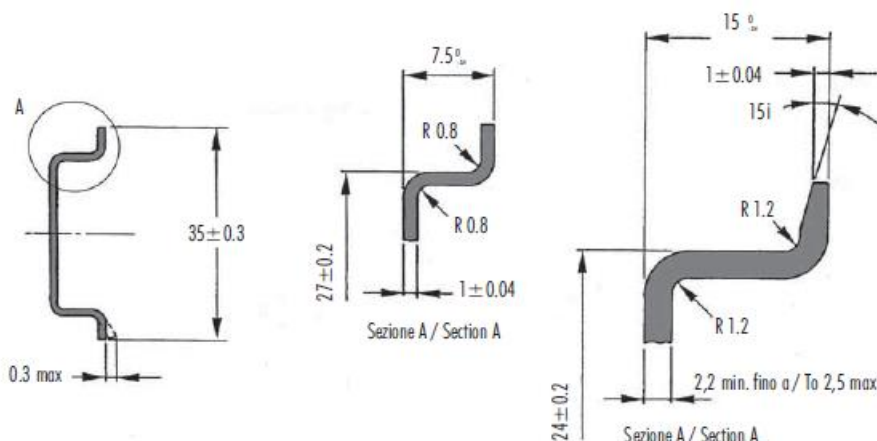

Figure 2.3 - DIN rail specification

The DIN rail clip is mounted on the bottom of the module at the back as shown in the figure below. Use a flat screwdriver to pull the clip downward. This will enable you to mount the module onto the DIN rail. Once the module is mounted onto the DIN rail the clip must be pushed upwards to lock the module onto the DIN rail.

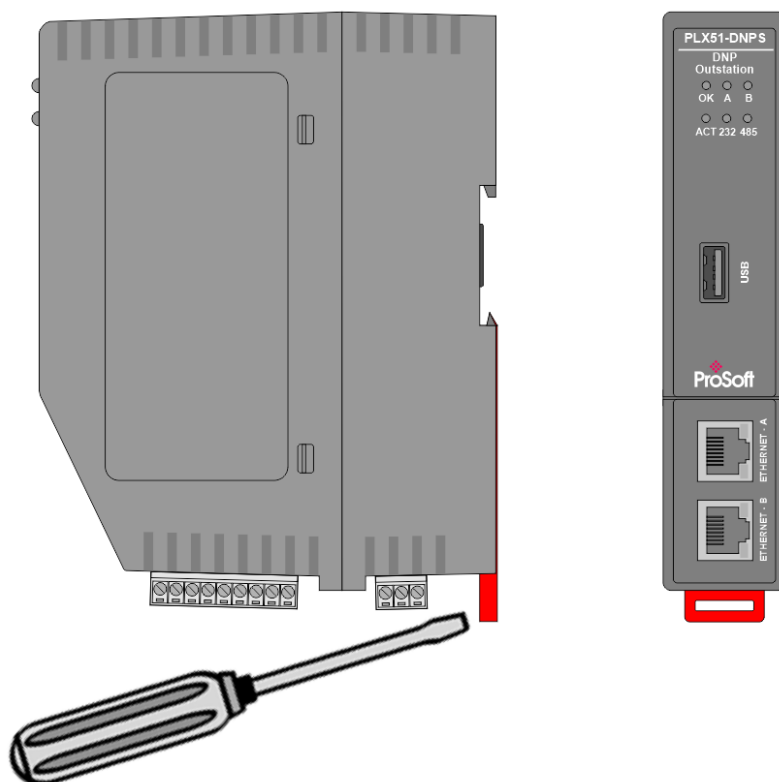

Figure 2.4 - DIN rail mouting

2.3 Power

A three-way power connector is used to connect Power+, Power- (GND), and earth. The module requires an input voltage of 10 – 32Vdc. Refer to the [“Technical Specifications”](#) section.

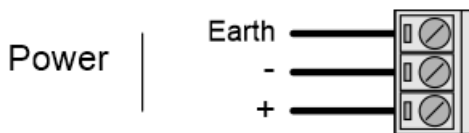

Figure 2.5 - Power connector

IMPORTANT: Attempting to operate the module at a voltage lower than 10 Vdc may cause the configuration to be cleared.

2.4 RS232/RS485 Port

The nine-way connector is used to connect the RS232 and RS485 conductors for serial communication. The shield terminal can be used for shielded cable in high noise environments.

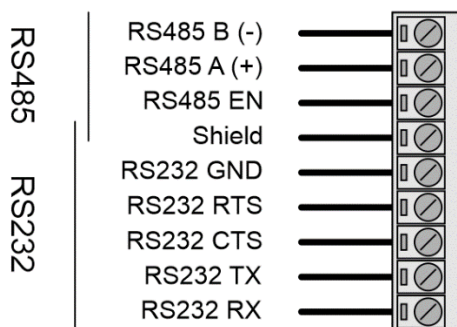

Figure 2.6 - RS232/RS485 connector

The RS485 port provides the standard A and B conductors as well as a RS485 drive enable. The (EN) transmit drive enable is provided to allow the DNP module to be used with repeaters and radios that may require a transmit enable line. Note that the EN line is referenced to RS232 GND.

The RS232 port provides the standard communication conductors (RX, TX, and GND) as well as hardware handshaking lines for legacy systems (RTS – Request to Send, CTS – Clear to Send).

Both RS232 and RS485 share a common cable shield connection which should be connected to the shield of the outgoing cable (RS232 and/or RS485).

IMPORTANT: The shield of the RS232/RS485 port is internally connected to the power connector earth. Thus, when using a shield, it is important to connect the Earth terminal on the power connector to a clean earth. Failing to do this can lower the signal quality of the RS232/RS485 communication.

IMPORTANT: When using a shielded cable, it is important that only one end of the shield is connected to earth to avoid current loops. It is recommended to connect the shield to the DNP module, and not to the other DNP module device.

2.5 RS485 Termination

All RS485 networks are required to be terminated at the extremities (start and end point) of the communication conductor. The termination for the RS485 network can be enabled or disabled via the module configuration. Enabling the termination will connect an internal 150 Ohm resistor across the positive (+) and negative (-) conductors of the RS485 network.

2.6 Ethernet Ports

The Ethernet connectors should be wired according to industry standards. Refer to the [“Additional Information”](#) section for further details.

The module has an embedded switch connecting the two Ethernet ports.

2.7 USB Port

The module supports USB2.0 on its USB port and will operate as a USB Host device. You will require a USB Type-A connector on the DNP module side and generally a USB Type-B connector on the device side (i.e. Logix Controller).

NOTE: The USB interface can only be used with Logix Controllers that have a USB port. The module cannot route (via USB) across the backplane from another module (e.g. EN2T) to a Logix controller.



Figure 2.7 – USB 2.0 Type-A to USB Type-B cable

3 Setup

3.1 Install Configuration Software

All network setup and configuration of the module is achieved by means of the ProSoft PLX50 Configuration Utility. This software can be downloaded from:

www.prosoft-technology.com



Figure 3.1 - ProSoft Technology PLX50 Configuration Utility software

3.2 Network Parameters

The module will have Dynamic Host Configuration Protocol (DHCP) enabled as factory default. A DHCP server must be used to provide the module with the required network parameters (IP address, subnet mask, etc.). There are a number of DHCP utilities available, however it is recommended that the DHCP server in the PLX50 Configuration Utility be used.

Within the PLX50 Configuration Utility environment, the **DHCP Server** can be found under the **Tools** menu.

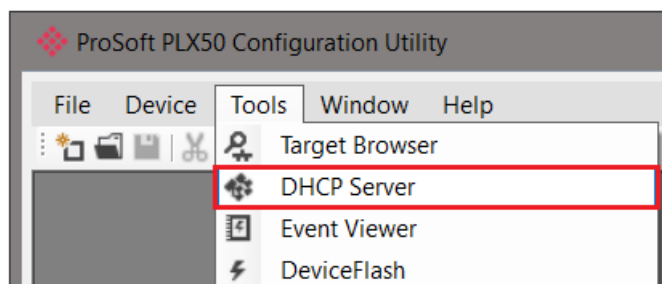

Figure 3.2 - Selecting DHCP server

Once opened, the DHCP server will listen on all available network adapters for DHCP requests and display their corresponding MAC addresses.

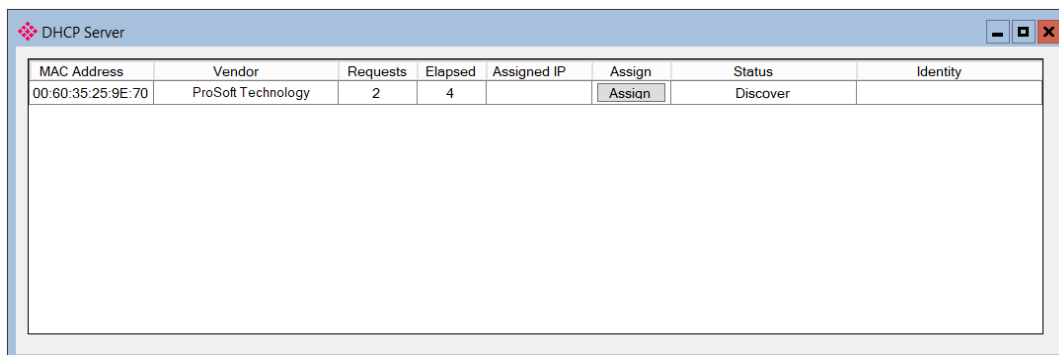

Figure 3.3 - DHCP server

NOTE: If the DHCP requests are not displayed in the DHCP Server it may be due to the local PC’s firewall. During installation the necessary firewall rules are automatically created for the Windows firewall. Another possibility is that another DHCP Server is operational on the network and it has assigned the IP address.

To assign an IP address, click on the corresponding “Assign” button. The Assign IP Address for MAC window will open.

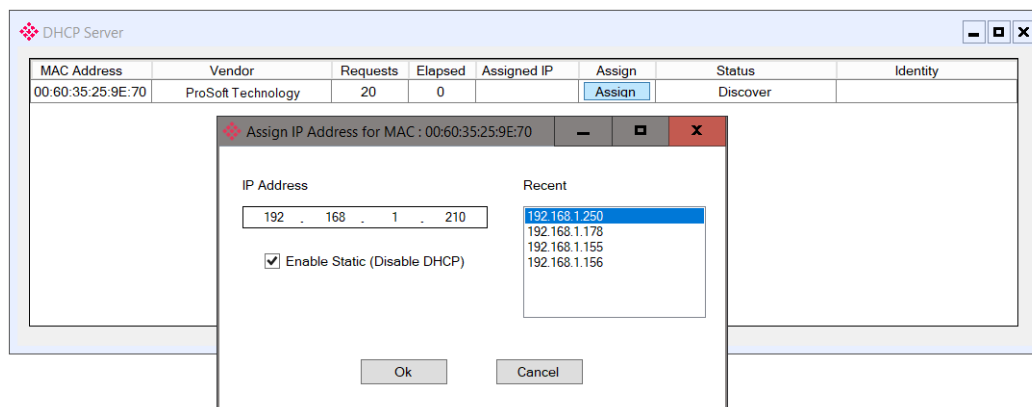

Figure 3.4 - Assigning IP address

The required IP address can then be either entered, or a recently used IP address can be selected by clicking on an item in the Recent List.

If the **Enable Static** checkbox is checked, then the IP address will be set to static after the IP assignment, thereby disabling future DHCP requests.

Once the IP address window has been accepted, the DHCP server will automatically assign the IP address to the module and then read the Identity object Product name from the device.

The successful assignment of the IP address by the device is indicated by the green background of the associated row.

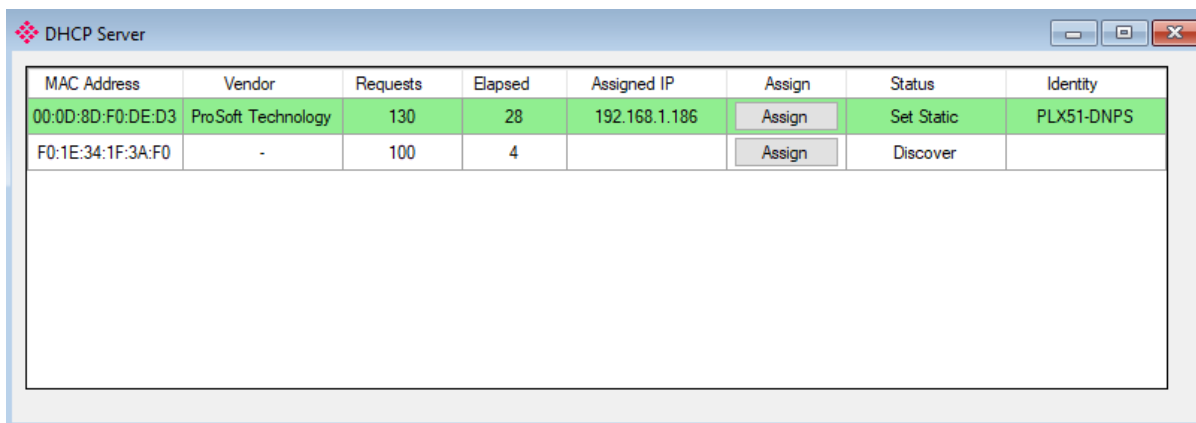

Figure 3.5 - Successful IP address assignment

It is possible to force the module back into DHCP mode by powering up the device with DIP switch 2 set to the On position.

A new IP address can then be assigned by repeating the previous steps.

IMPORTANT: It is important to return DIP switch 2 back to Off position, to avoid the module returning to a DHCP mode after the power is cycled again.

In addition to the setting the IP address, a number of other network parameters can be set during the DHCP process. These settings can be viewed and edited in PLX50 Configuration Utility’s Application Settings, in the DHCP Server tab.

Once the DHCP process has been completed, the network settings can be set using the Ethernet Port Configuration via the **Target Browser**.

The **Target Browser** can be accessed under the **Tools** menu.

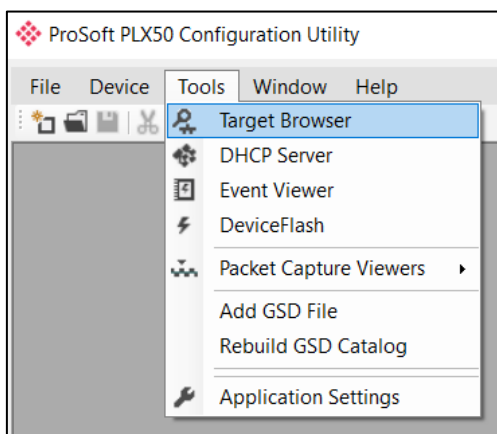

Figure 3.6 - Selecting the Target Browser

The Target Browser automatically scans the Ethernet network for EtherNet/IP devices.

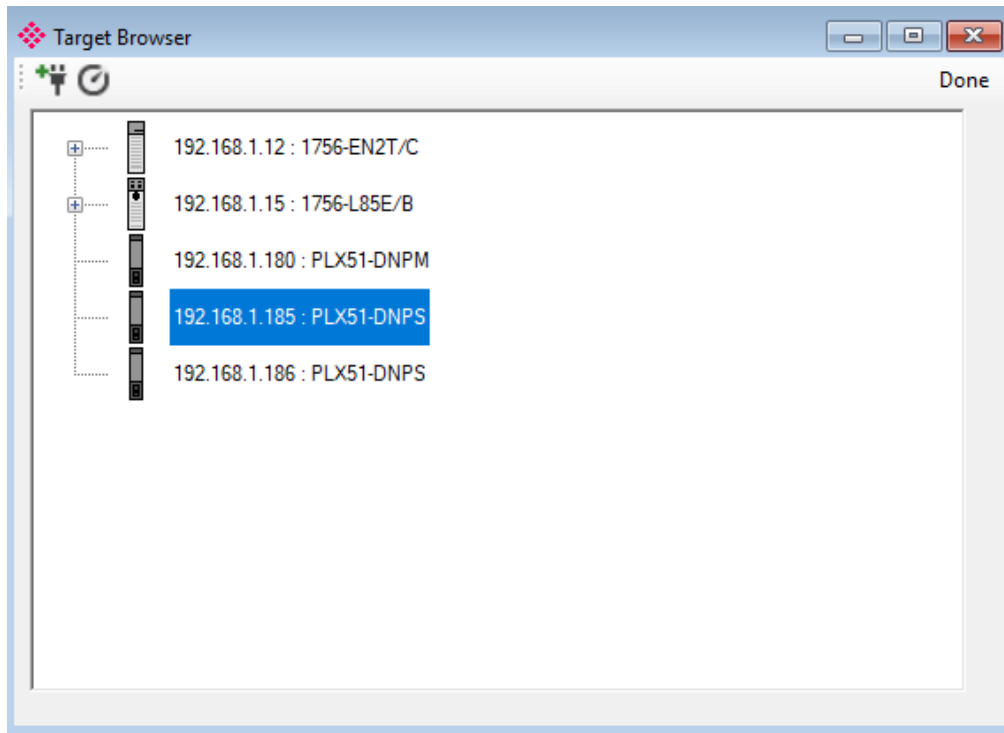

Figure 3.7 - Target Browser

Right-clicking on a device, reveals the context menu, including the **Port Configuration** option.

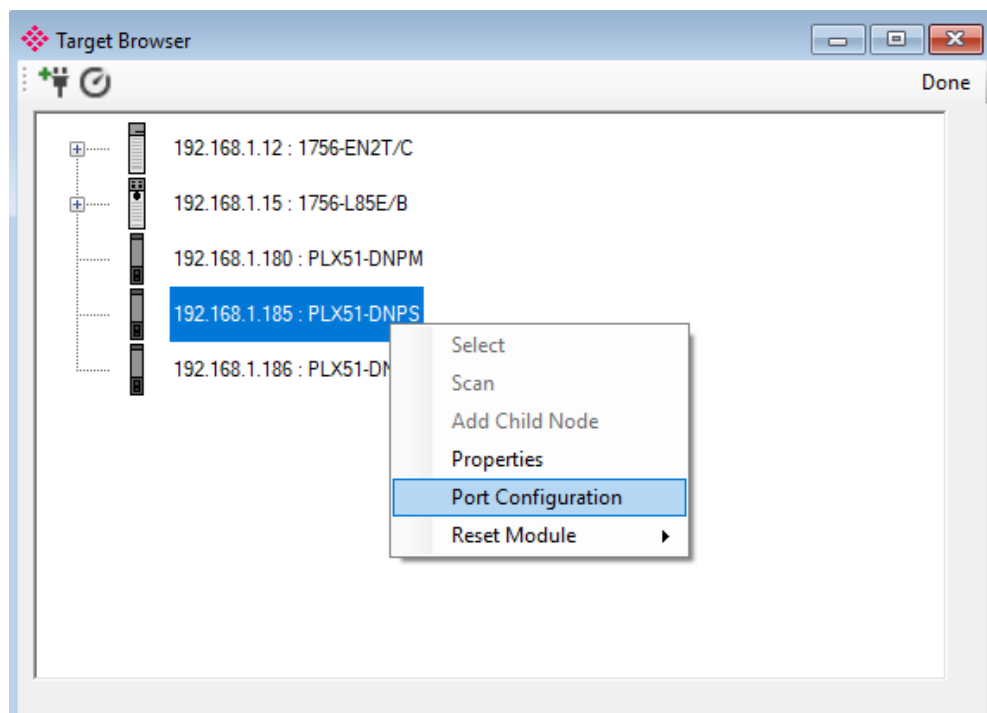

Figure 3.8 - Selecting Port Configuration

The relevant Ethernet port configuration parameters can be modified using the *Ethernet Port Configuration* window.

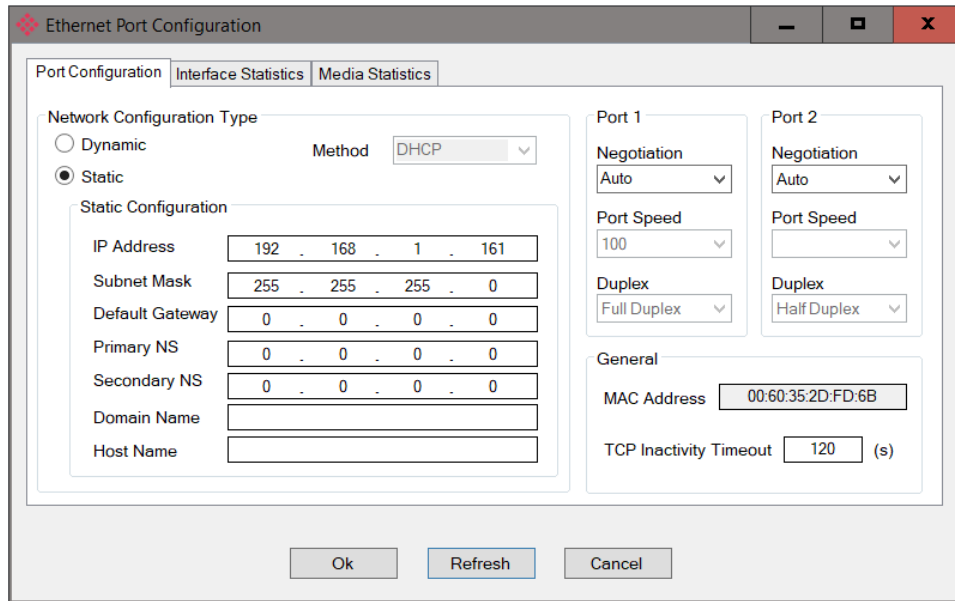

Figure 3.9 - Port Configuration

Alternatively, these parameters can be modified using Rockwell Automation's RSLinx software.

3.3 Creating a New Project

- 1 Before you can configure the module, a new PLX50 Configuration Utility project must be created. Under the **FILE** menu, select **NEW**.

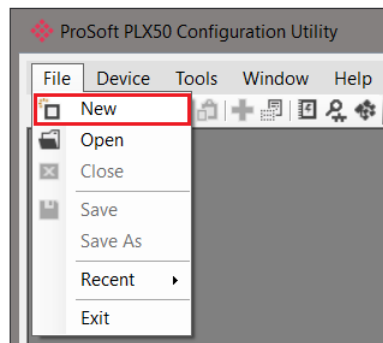

Figure 3.10 - Creating a new project

- 2 A PLX50 Configuration Utility project will be created, showing the *Project Explorer* tree view. To save the project, use the **SAVE** option under the **FILE** menu.
- 3 A new device can now be added by selecting **ADD** under the **DEVICE** menu.

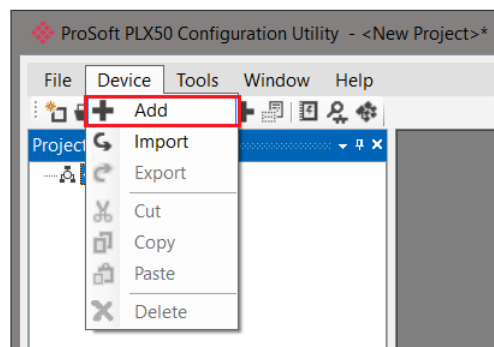

Figure 3.11 - Adding a new device

- 4 In the *Add New Device* window, select **PLX51-DNPS**, and click the **OK** button.

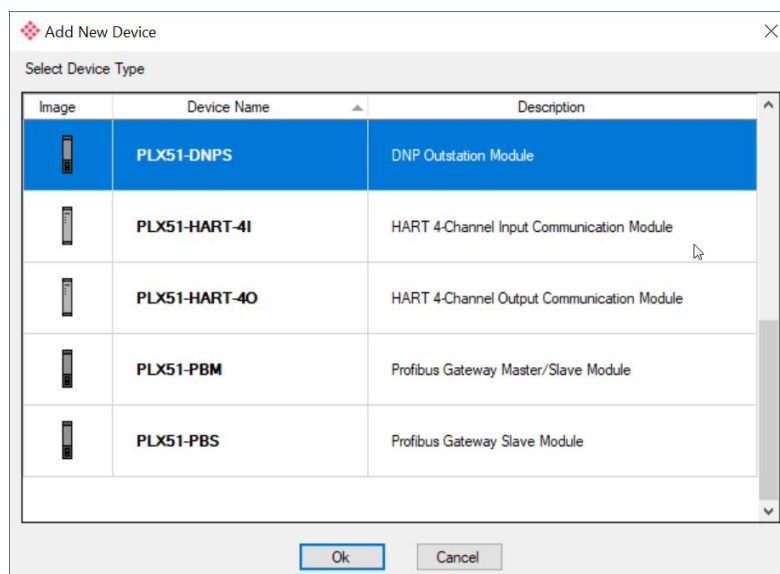

Figure 3.12 – Selecting a new PLX51-DNPS module

- 5 The device will appear in the **Project Explorer** tree as shown below, and its configuration window opened.
- 6 The device configuration window can be reopened by either double-clicking the module in the Project Explorer tree or right-clicking the module and selecting **CONFIGURATION**.

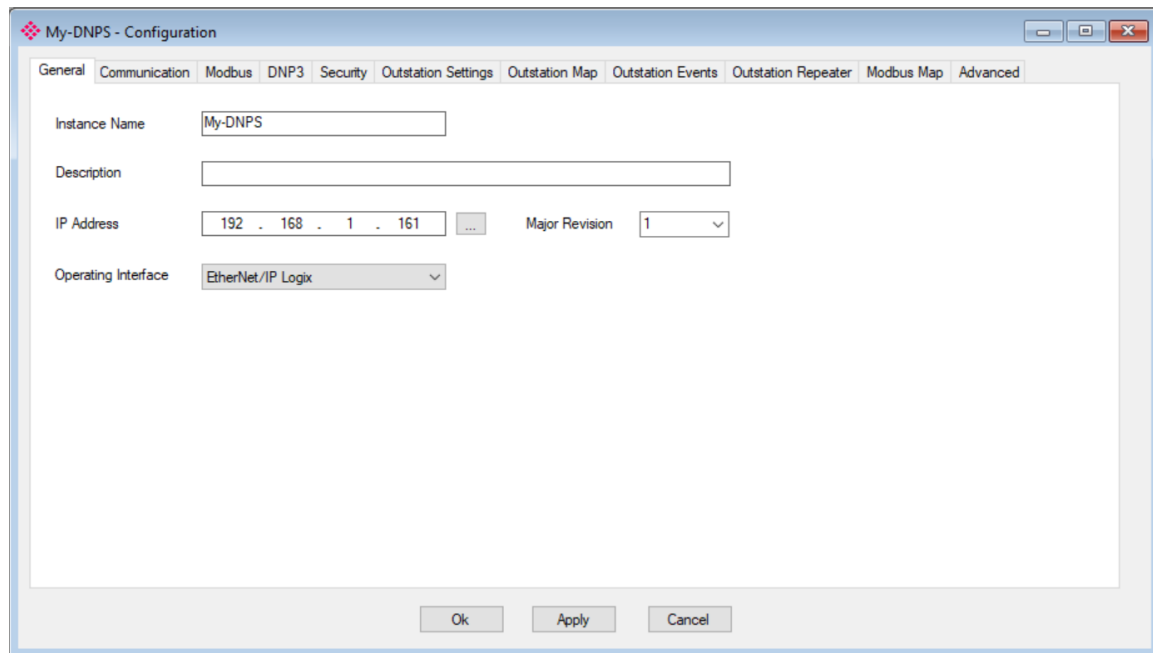

Figure 3.13 – PLX51-DNPS configuration

3.4 PLX51-DNPS Configuration

The PLX51-DNPS is configured by means of the PLX50 Configuration Utility. Refer to the [“Additional Information”](#) section for documentation and installation links for ProSoft Technology PLX50 Configuration Utility. The configuration consists of multiple configuration tabs. When downloading this configuration into the module, it will be saved in non-volatile memory that persists when the module is powered down.

IMPORTANT: When a firmware upgrade is performed, the module will clear all DNP3 configuration and routing maps.

3.4.1 General

The *General* configuration is shown in the figure below. The general configuration window is opened by either double-clicking on the module in the tree, or right-clicking the module and selecting *Configuration*.

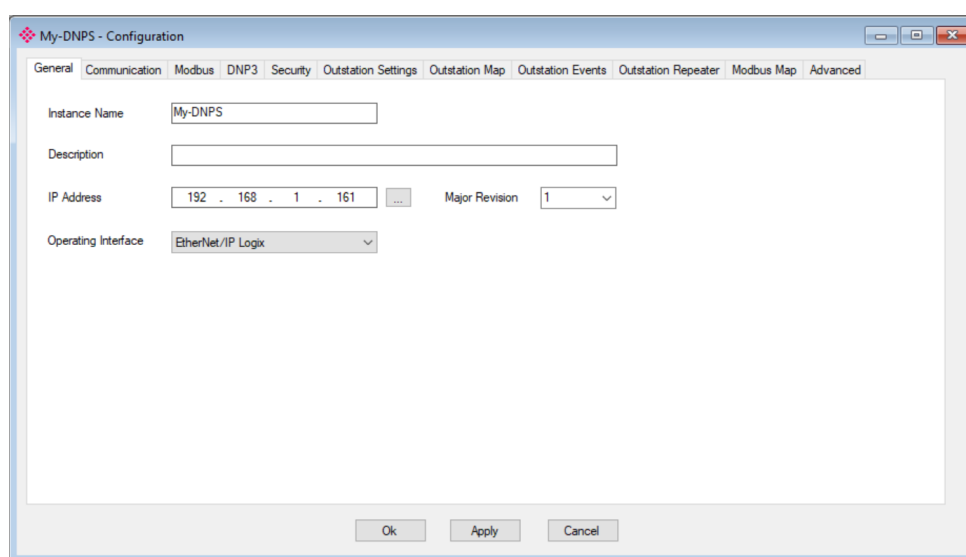

Figure 3.14 - General configuration

The general configuration consists of the following parameters:

Parameter	Description
Instance Name	This parameter is used to identify between various PLX51-DNPS modules.
Description	This parameter is used to provide a description of the application for the module.
IP Address	The IP address of the module.
Major Revision	The major revision of the module
Operating Interface	<p>This is the network the PLX51-DNPS will interface the DNP3 network.</p> <ul style="list-style-type: none"> ▪ EtherNet/IP Logix ▪ EtherNet/IP Micro800 ▪ CIP USB Logix <p>NOTE: CIP USB can only be used on Logix Controllers with USB Ports. The module cannot route via USB from another module, e.g. EN2T, to a Logix controller.</p> <ul style="list-style-type: none"> ▪ Modbus TCP Master ▪ Modbus RTU Master – RS232 ▪ Modbus RTU Master – RS485 ▪ Modbus TCP Slave ▪ Modbus RTU Slave – RS232 ▪ Modbus RTU Slave – RS485

Table 3.1 - General configuration parameters

3.4.2 Communication

The *Communication* configuration is shown in the figure below.

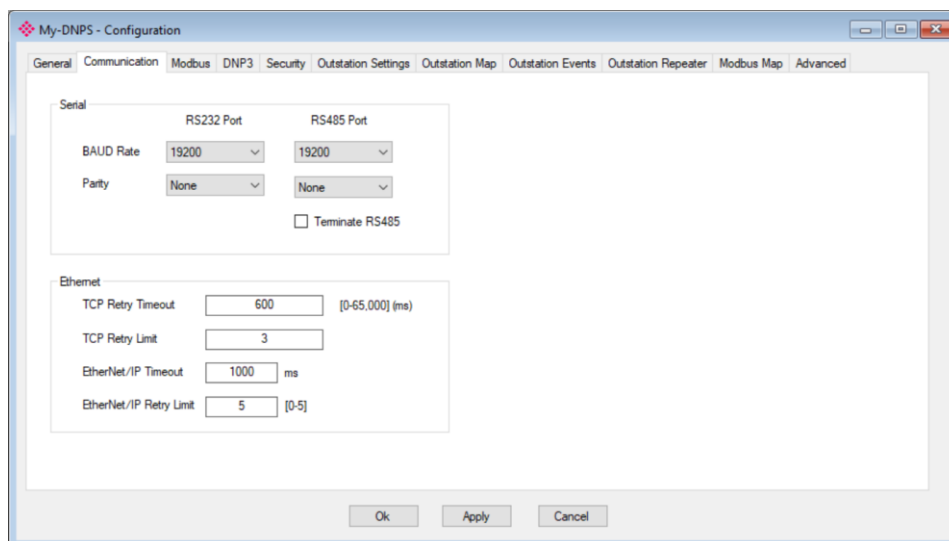

Figure 3.15 - Communication configuration

The communication configuration consists of the following parameters:

Parameter	Description
<i>RS232 Port</i>	
BAUD Rate	BAUD Rate for the RS232 serial communication (DNP3 / Modbus-RTU). NOTE: When baud rates below 9600 has been set (for either DNP3 or Modbus), you will need to increase the timeout or response timeout for the specific protocol (e.g. DNP3 or Modbus) in the PLX50CU. It is recommended to set the timeout to 2000+ms for any baud rate below 9600 bps.
Parity	Parity setting for the RS232 serial communication (DNP3 / Modbus-RTU).
<i>RS485 Port</i>	
BAUD Rate	BAUD Rate for the RS485 serial communication (DNP3 / Modbus-RTU). NOTE: When baud rates below 9600 has been set (for either DNP3 or Modbus), you will need to increase the timeout or response timeout for the specific protocol (e.g. DNP3 or Modbus) in the PLX50CU. It is recommended to set the timeout to 2000+ms for any baud rate below 9600 bps.
Parity	Parity setting for the RS485 serial communication (DNP3 / Modbus-RTU).
Terminate RS485	Enables the on-board 124Ω RS485 terminating resistor.
<i>Ethernet</i>	
TCP Retry Timeout	If the PLX51-DNPS (with Protocol TCP) has sent a request or a response to another node and no TCP ACK has been received after the retry timeout, then the TCP layer will be sent again.
TCP Retry Limit	The number of TCP retries sent before the response is flagged as failed.
EtherNet/IP Retry Timeout	The interval between retries when an EtherNet/IP message exchange has failed.
EtherNet/IP Retry Limit	Determines how many times the module must retry the EtherNet/IP message exchange before failing it.

Table 3.2 - Communication configuration parameters

NOTE: In bad communication areas or applications, the TCP retry (when using TCP protocol) can help with responses that are lost due to intermittent communication.

NOTE: The module supports 8 data bits and 1 stop bit.

3.4.3 Modbus

The *Modbus* configuration is shown in the figure below.

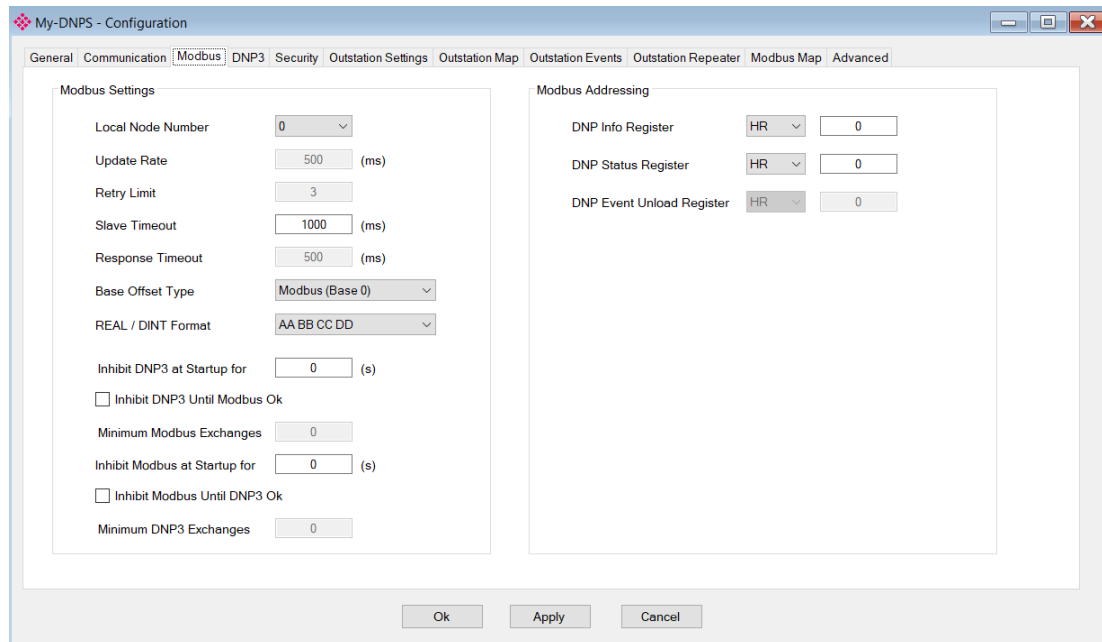

Figure 3.16 - Modbus configuration

The Modbus configuration consists of the following parameters:

Parameter	Description
<i>Modbus Settings</i>	
Local Node Number	The Modbus Node Number that will be used by the PLX51-DNPS.
Update Rate	The period (in milliseconds) between master requests to the target Modbus device. (Modbus Master only)
Retry Limit	The number of successive Modbus request retries (Modbus Master only)
Slave Timeout	The slave timeout time in milliseconds (Modbus Slave only)
Response Timeout	The time (in milliseconds) the module will wait for a Modbus response (Modbus Master only)
Base Offset Type	Base Address Offset Type Modbus (Base 0) – Conventional Modbus addressing where the first address is 0. PLC (Base 1) – PLC addressing, where the first address is 1.
REAL / DINT Format	For a Real (single floating point) number this setting shows the format of the data will be presented when using a Modbus Primary Interface. The format (byte re-ordering) options are as follows: <ul style="list-style-type: none"> ▪ AA BB CC DD ▪ BB AA DD CC ▪ DD CC BB AA ▪ CC DD AA BB
Inhibit DNP3 at Startup for	When the modules boot up, the DNP3 communication and exchanges will be inhibited for this parameter number of seconds. NOTE: When the inhibit time and inhibit exchange count are both enabled, then the DNP communication will start once the first one of these criteria is met.
Inhibit DNP3 Until Modbus Ok	The option will force the module to inhibit DNP3 communication until the Modbus interface has successfully exchanged the configured minimum number (below).
Minimum Modbus Exchanges	If the <i>Inhibit DNP3 Until Modbus Ok</i> option is selected, this parameter is the number of Modbus exchanges before DNP3 communication is activated.

	NOTE: When the inhibit time and inhibit exchange count are both enabled, then the DNP communication will start once the first one of these criteria is met.
Inhibit Modbus at Startup for	When the modules boot up, the Modbus communication and exchanges will be inhibited for this parameter number of seconds. NOTE: When the inhibit time and inhibit exchange count are both enabled, then the Modbus communication will start once the first one of these criteria is met.
Inhibit Modbus Until DNP3 Ok	The option will force the module to inhibit Modbus communication until the DNP3 interface has successfully exchanged the configured minimum number (below).
Minimum DNP3 Exchanges	If the <i>Inhibit Modbus Until DNP3 Ok</i> option is selected, this parameter is the number of DNP3 exchanges before Modbus communication is activated. NOTE: When the inhibit time and inhibit exchange count are both enabled, then the Modbus communication will start once the first one of these criteria is met.
<i>Modbus Addressing</i>	
DNP Info Register	The Modbus Register for module Information. See the “Modbus Operation” section for more information.
DNP Status Register	The Modbus Register for DNP3 Status. See the “Modbus Operation” section for more information.
DNP Event Unload Register	N/A

Table 3.3 - Modbus configuration parameters

3.4.4 DNP3

The DNP3 configuration is shown in the figure below.

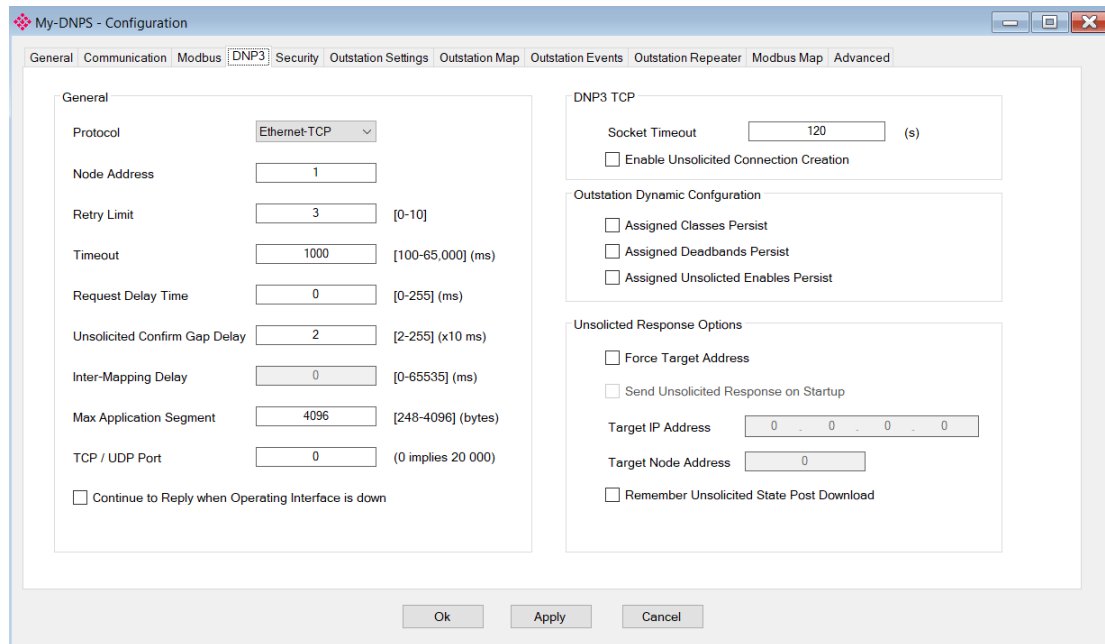

Figure 3.17 – DNP3 configuration

The DNP3 configuration consists of the following parameters:

Parameter	Description
<i>General</i>	
Protocol	The PLX51-DNPS can interface to the DNP3 device(s) on either: <ul style="list-style-type: none"> ▪ Ethernet-TCP ▪ Ethernet-UDP ▪ Serial RS232 ▪ Serial RS485
Node Address	The node address of the PLX51-DNPS is only configurable in Unscheduled mode. In all other modes, the node address is dynamically changed to suit the required mapping.
Retry Limit	The retry limit determines how many times the module must retry the message exchange before failing it.
Timeout	The timeout is used to determine the interval between retries when a message exchange has failed.
Request Delay Time	The reply message wait is the minimum delay before the DNP3 reply is transmitted to the DNP3 device.
Unsolicited Confirm Gap Delay	The amount of time the execution of the next scheduled mapped item is delayed after a confirm message has been sent to an Outstation. This is useful in low bandwidth network where repeaters are used, or unsolicited responses are received.
Inter-Mapping Delay	N/A
Max Application Segment	The maximum application segment size that will be sent per response. For example, if the DNP3 response is 1000 bytes in size and the application segment max is 500, then the PLX51-DNPS will send an application segment of 500 bytes and request a confirm. Once the confirmation has been received from the DNP3 Master the next 500 bytes of application data will be sent.
TCP / UDP Port	The DNP3 TCP and UDP port numbers can be configured using this parameter. If the user enters 0, the port will default to the standard 20000 for DNP3.

Continue to Reply when Operating Interface is down	<p>When selected, the module will continue to reply to DNP3 requests. The module will also reply with <i>Device Trouble</i> in the DNP3 device indicator flags.</p> <p>NOTE: When the EtherNet/IP interface is using more than one Logix controller, and only one of the Logix controllers are down, the module will keep replying with the data from the online Logix controller.</p>
<i>DNP3 TCP</i>	
Socket Timeout	<p>When using DNP3 TCP, you have the ability to set the timeout of the TCP socket that will be used. This will allow for unsolicited communication over the same TCP sockets from the DNP3 Master over an extended period of time. This value defaults to 120s.</p>
Enable Unsolicited Connection Creation	<p>When using DNP3 TCP, the module has the ability to create a TCP connection to the DNP3 master when unsolicited responses must be sent. This will allow for unsolicited communication without the need to worry about TCP socket timeouts.</p> <p>NOTE: Certain DNP3 Masters will not allow a DNP3 Outstation to create a TCP connection on the DNP3 Master.</p>
<i>Outstation Dynamic Configuration</i>	
Assigned Classes Persist	<p>When selected, the assigned DNP event classes received from the DNP3 Master will persist (i.e., saved into NV memory). When the module reboots it will use the configuration received from the DNP Master and apply it to the static configuration that was configured using PLX50CU. See the <i>DNP3 Dynamic Configuration</i> section for more details.</p>
Assigned Deadbands Persist	<p>When selected, the assigned DNP analog deadbands received from the DNP3 Master will persist (i.e., saved into NV memory). When the module reboots it will use the configuration received from the DNP Master and apply it to the static configuration that was configured using PLX50CU. See the <i>DNP3 Dynamic Configuration</i> section for more details.</p>
Assigned Unsolicited Enables Persist	<p>When selected, the enabled Unsolicited Responses received from the DNP3 Master will persist (i.e., saved into NV memory). When the module reboots it will use the configuration received from the DNP Master and apply it to the static configuration that was configured using PLX50CU. See the <i>DNP3 Dynamic Configuration</i> section for more details.</p> <p>NOTE: If the Force Target Address has not been enabled, the unsolicited responses will only become active once a enable or disable unsolicited responses command is received from the DNP Master.</p>
<i>Unsolicited Response Options</i>	
Force Target Address	<p>This will force all unsolicited responses to be sent to a specific target address (which is set in the parameters below).</p>
Send Unsolicited Response at Startup	<p>When set, the module will send a wake up unsolicited response to the target address.</p>
Target IP Address	<p>The IP Address of the target devices for unsolicited responses.</p>
Target Node Address	<p>The DNP3 Node Address of the target devices for unsolicited responses.</p>
Remember Unsolicited State Post Download	<p>When selected, the state of unsolicited responses (enabled or disabled) will remain unchanged when a download occurs. When this has not been selected, the Unsolicited Responses will be disabled when a download occurs.</p>

Table 3.4 – DNP3 configuration parameters

NOTE: In bad communication areas or applications, it is recommended to set the Max Application Segment size lower. This will result in a higher probability of packets successfully arriving at the destination address because of the packet confirmation.

3.4.5 Security

The DNP3 *Security* configuration is shown in the figure below.

NOTE: The actual pre-shared key cannot be included in the configuration. It can only be written to the PLX51-DNPS module when online via the **Status** window.

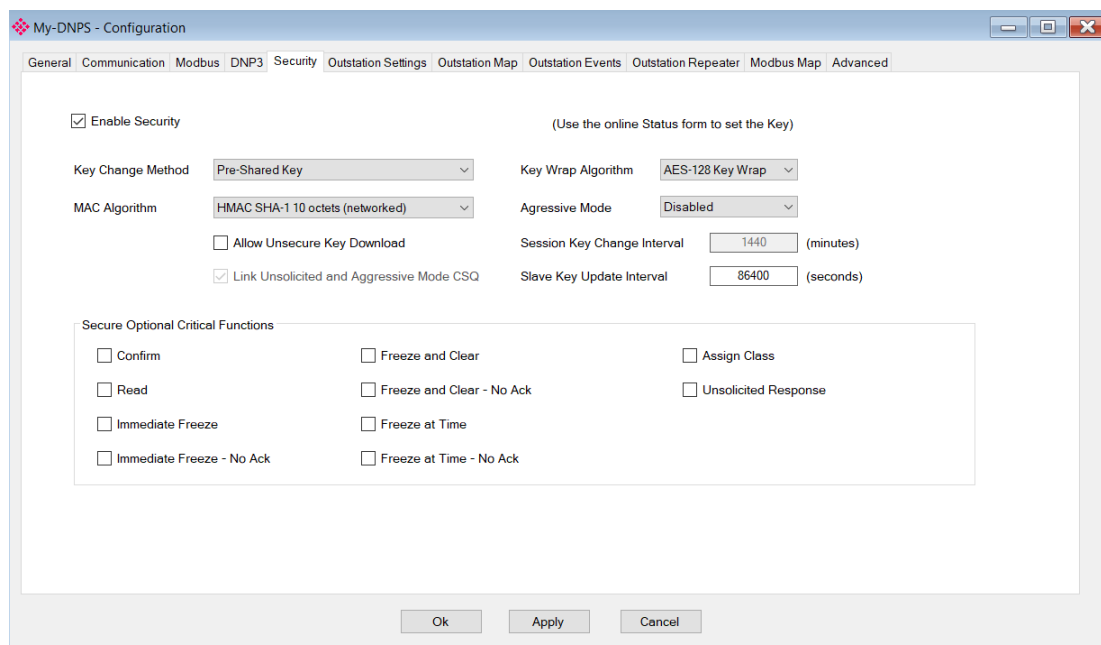

Figure 3.18 - Security configuration

The Security configuration consists of the following parameters:

Parameter	Description
Enable Security	DNP3 Secure Authentication can be enabled or disabled. When enabled there will be no exchange of data (for critical functions).
Key Change Method	This setting determines the method by which security keys are exchanged between two devices. The PLX51-DNPS supports only the Pre-Shared Key method. When using this method both devices need to have update keys entered by means outside the DNP3 protocol. NOTE: There are two options to be selected with the Key Change Method. Pre-Shared Key This is normal operation and the Update Keys will have to be changed locally for each PLX51-DNPS. Pre-Shared Key – Allow Remote Update This option allows you to remotely change the update key over the DNP3 Network. See the “Security” section for more details regarding this.
MAC Algorithm	The MAC algorithm is used to encrypt the challenge data for secure authentication. DNP3 allows for various encryption standards in different formats to be used for secure authentication: <ul style="list-style-type: none"> ▪ HMAC SHA-1 encryption (4 octets – serial) – for legacy support ▪ HMAC SHA-1 encryption (8 octets – serial) ▪ HMAC SHA-1 encryption (10 octets – networked) ▪ HMAC SHA-256 encryption (8 octets – serial) ▪ HMAC SHA-256 encryption (16 octets – networked) ▪ AES-GMAC (12 octets)

Key Wrap Algorithm	DNP3 uses various keys for secure authentication. The keys that are used for data exchange and called the session keys and these keys may be updated frequently. To exchange the session keys between two DNP3 devices the update key (refer to the “DNP3 Secure Authentication” section for further detail) is used to encrypt the data and session keys before exchanging it between parties. DNP3 allows for two standards to encrypt the session keys: <ul style="list-style-type: none"> ▪ AES-128 Key Wrap ▪ AES-256 Key Wrap
Aggressive Mode	To reduce the bandwidth used for secure authentication, you can select aggressive mode which allows the message initiator to anticipate and provide the required authentication in the request message. Thus from a network point of view there is a two message exchange for secure authentication compared to the normal four message exchange for secure authentication.
Link Unsolicited and Aggressive Mode CSQ	Ensure that the Challenge Sequence Numbers (CSQ) of unsolicited requests and Aggressive Mode requests are the same.
Secure Optional Critical Functions	When secure authentication is enabled there are various mandatory and optional application functions that must be authenticated before data can be exchanged. The optional functions can be selected in the box. Mandatory functions, e.g. Operate, are therefore not included in the options list.
Allow Unsecure Key Download	When selected, you will be able to change the Update and Transfer Keys (unsecure) using a Logix MSG instruction. See the “Security” section for more details.
Session Key Change Interval	(PLX51-DNPM only) This is the time (in minutes) when the PLX51-DNPM is forced to update the session keys.
Slave Key Update Interval	This parameter will force the current session keys in the DNPS module to be cleared after x seconds, which will result in the DNP3 Master issuing new session keys.

Table 3.5 – Security configuration parameters

NOTE: For further information regarding the security settings, refer to the [“Security”](#) section.

3.4.6 Outstation Settings

The DNP3 *Outstation Settings* configuration is shown in the figure below.

The Master Filter allows the PLX51-DNPS to respond to only specific DNP3 masters. The Device Attributes can be setup to make the PLX51-DNPS appear like any DNP3 Outstation.

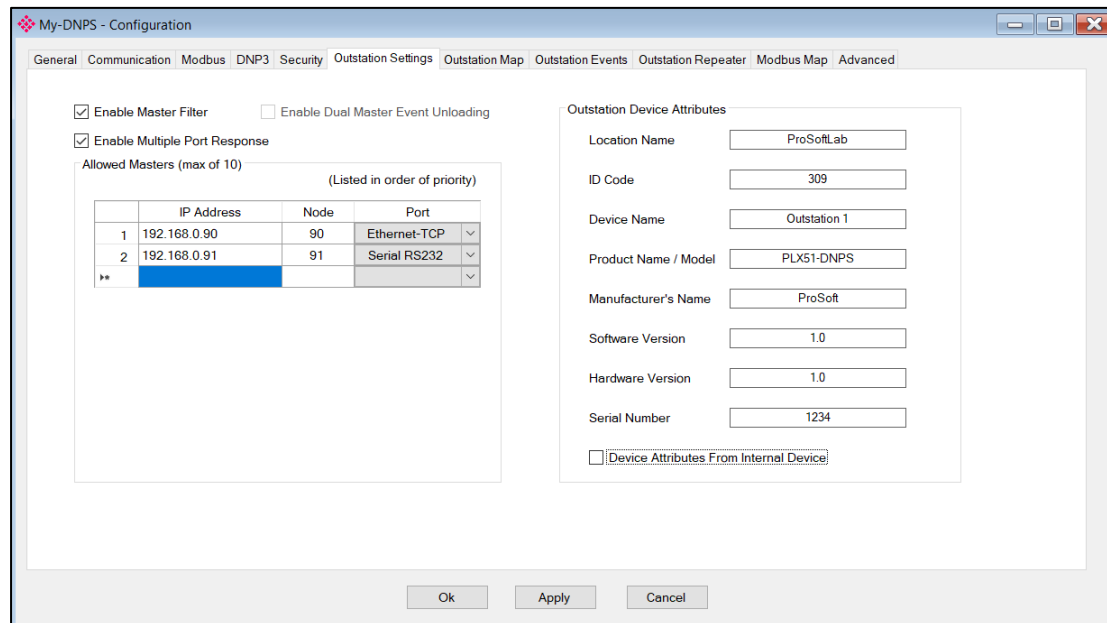

Figure 3.19 – Outstation Settings configuration

The Outstation Settings Attributes configuration consists of the following parameters:

Parameter	Description
<i>Master Filter</i>	
Enable Master Filter	<p>The PLX51-DNPS can have a DNP3 Master allowed list. This can help reducing risks of unauthorized DNP3 Masters exchanging data with the DNP3 Outstation.</p> <p>It also allows the PLX51-DNPS to switch between DNP3 masters (if a DNP3 Master were to go offline) when sending Unsolicited Responses. Should the DNP3 Master currently being used for unsolicited responses were to go offline, the PLX51-DNPS will go through the list to find the next DNP3 Master which can receive unsolicited responses.</p> <p>NOTE: The DNP3 Masters in the list are listed from highest priority to lowest (where the highest priority DNP3 Master is at the top). Should a DNP3 master with a higher priority reconnect, then the PLX51-DNPS will redirect its Unsolicited responses to that DNP3 master.</p> <p>The following criteria can be used to allow a DNP3 Master:</p> <p>IP Address This is IP Address of the allowed DNP3 master. (Note that this field is only available with Ethernet communication e.g. TCP or UDP).</p> <p>Node Address The Node Address of the allowed master.</p> <p>Port (when <i>Enable Multiple Port Responses</i> is selected) The DNP3 port of the allowed master.</p>

	<p>NOTE: When this option is selected the <i>Enable Dual Master Event Unloading</i> cannot be enabled.</p>
Enable Dual Master Event Unloading	<p>This option will allow the DNPS module to unload DNP events to two DNP Masters. The module will keep track of each DNP Master’s unloading such that events are never duplicated or lost for either Master (even if one of the DNP Masters are offline).</p> <p>The following criteria can be used to allow a DNP3 Master:</p> <p>IP Address This is IP Address of the allowed DNP3 master. (Note that this field is only available with Ethernet communication e.g. TCP or UDP).</p> <p>Node Address The Node Address of the allowed master.</p> <p>Port (when <i>Enable Multiple Port Responses</i> is selected) The DNP3 port of the allowed master.</p> <p>See the <i>Dual DNP3 Master Event Unloading</i> section for more details.</p> <p>NOTE: When this option is selected the <i>Enable Master Filter</i> cannot be enabled.</p> <p>NOTE: When this option is selected, there must be two Masters entered into the Allowed Masters List.</p>
Enable Multiple Port Response	<p>This parameter will enable the DNPS module to respond on all DNP3 ports (TCP, UDP, RS232, and RS485) simultaneously. Thus, the DNP3 protocol selected in the <i>DNP3</i> configuration tab will only be relevant for the force and startup unsolicited responses also configured in the <i>DNP3</i> configuration tab.</p> <p>This parameter will also allow the user to selected different ports (TCP, UDP, RS232, or RS485) for each Master in the allowed Master List (if <i>Enable Master Filter</i> is enabled).</p>
<i>Outstation Device Attributes</i>	
Location Name	This parameter is a name or code given to the location where the device is installed by the end user.
ID Code	This parameter is the code or number given to the device by the end user.
Device Name	This parameter is the name given to the device by the end user.
Product Name/Model	This parameter is the device manufacturer’s product name and model
Manufacturer’s Name	This parameter is the name of the device manufacturer.
Software Version	This attribute is the version code of the manufacturer’s device software.
Hardware Version	This attribute is the version code of the manufacturer’s device hardware.
Serial Number	This attribute is the serial number assigned by the device manufacturer.
Device Attributes from Internal Device	When this option is selected, the Device Name, Product Name, Manufacturer’s Name, Software Version, and Serial Number will be populated using the module’s internal values.

Table 3.6 – Outstation Settings configuration parameters

3.4.7 Outstation Events

The *Outstation Events* configuration is shown in the figure below.

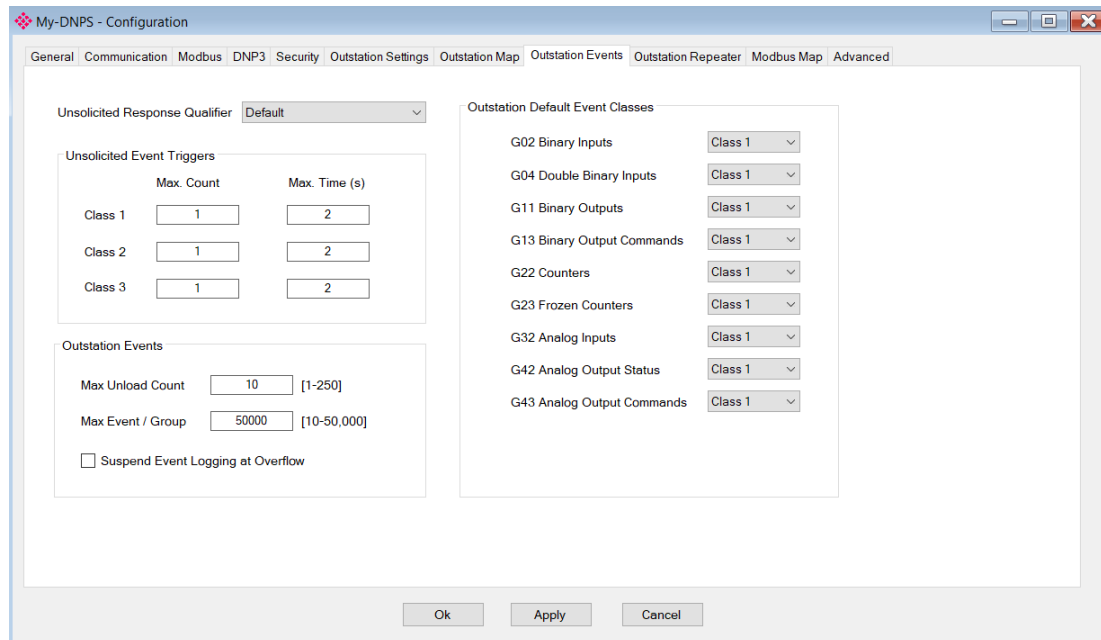

Figure 3.20 – Outstation Events configuration

The Outstation Events configuration consists of the following parameters:

Parameter	Description
Unsolicited Response Qualifier	<p>This parameter allows you to select which qualifier must be used when sending Unsolicited Responses.</p> <p>Default The qualifier will be 2-byte Prefix and 1-byte Object Count. 1 byte Prefix / 1 byte Count The qualifier will be 1-byte Prefix and 1-byte Object Count. 2 byte Prefix / 1 byte Count The qualifier will be 2-byte Prefix and 1-byte Object Count. 2 byte Prefix / 2 byte Count The qualifier will be 2-byte Prefix and 2-byte Object Count.</p>
Unsolicited Event Trigger	<p>The Event triggers can be used by the PLX51-DNPS to limit the amount of individual unsolicited responses sent to the DNP3 Master. To reduce traffic, you can set limits, one of which must be reached, before an unsolicited response is sent. The follow criteria can be used:</p> <p>Max Count This is the number of events that must be buffered by the PLX51-DNPS before an unsolicited response is sent (when enabled by the DNP3 Master). The minimum is 1, implying every event received is sent immediately to the DNP3 Master.</p> <p>Max Time The maximum time parameter is used to send an unsolicited response when there have been events buffered for a preconfigured amount of time. If the Max Time is set to 10s then if there are events in the event buffer for longer than 10s the PLX51-DNPS will send the events currently in the event buffer.</p>
Outstation Default Event Classes	<p>Each DNP3 Group which has the ability to log events must be assigned an Event Class. You can select either Class 1, 2, or 3. This will be used when events are being unloaded based on the DNP3 Event Class requested.</p>

	NOTE: This will only be applied if the Class in the mapped item is set to Default. If it is set to any other value the Class selected in the mapped item will overwrite this value.
Max Unload Count	The maximum number of events that will be returned per event class per request.
Max Event / Group	The maximum number of events that will be logged for a specific DNP3 Group. This will default to 50,000.
Suspend Event Logging at Overflow	The user can select to either have the module keep logging (and overwrite the oldest events) or stop logging once the max event count is reached.

Table 3.7 – Outstation Events configuration parameters

3.4.8 Outstation Repeater

The *Outstation Repeater* configuration is shown in the figure below.

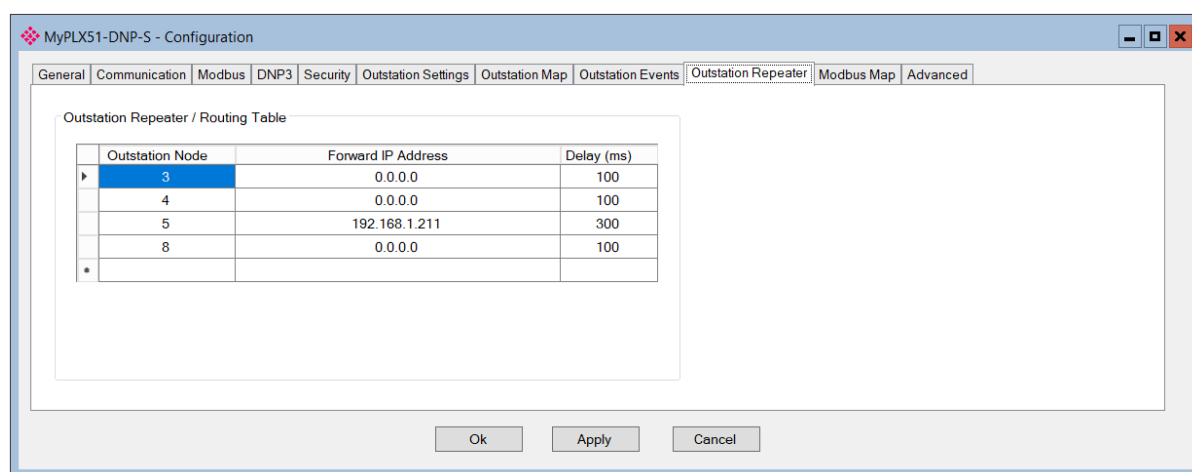

Figure 3.21 – Outstation Repeater configuration

The Outstation Repeater / Routing Table configuration consists of the following parameters:

Parameter	Description
Outstation Node	When a message on the network has the following node address in either the source or destination address it will be repeated. Note that the PLX51-DNPS will keep a lookup table of recent messages to avoid repeating a repeated message.
Forward IP Address	When you want to make use of the Routing functionality, this is the IP address of the PLX51-DNPS to which the messages will be routed.
Delay (ms)	This is the amount of time the PLX51-DNPS must wait before repeating the message. This can be used to allow multiple repeater paths to the same outstation without causing collisions on the radio network. It can also be used in instances where certain radios/implementations require some "dead" time before another message is sent.

Table 3.8 – Outstation Repeater configuration parameters

3.4.9 Modbus Map

The *Modbus Map* configuration is shown in the figure below. This table will be enabled when configured for Modbus Master. This will allow you to read and/or write any internal PLX51-DNPS Modbus Register to any Modbus Slave. Up to 20 Modbus Slaves can be connected and up to 100 mapped items can be configured.

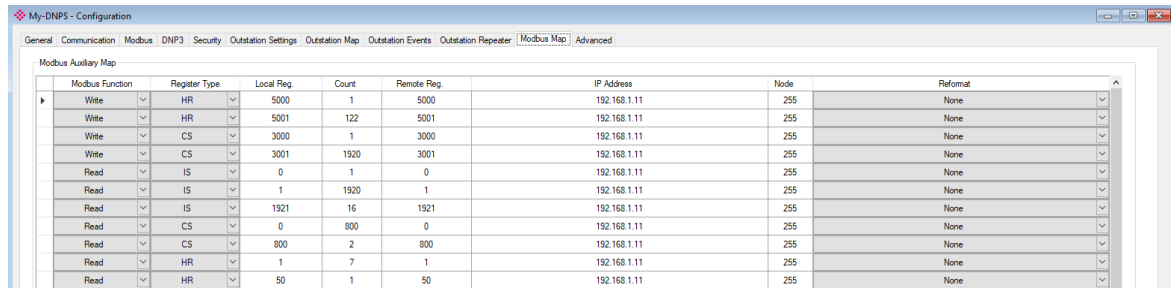

Figure 3.22 – PLX51-DNPS Modbus Auxiliary Map configuration

The Modbus Auxiliary Map configuration consists of the following parameters:

Parameter	Description
Modbus Function	This is the Modbus function used with the Modbus Slave. Read – Read a Modbus Register (eg. HR, IR, CS, or IS) from a Modbus Slave. Write – Write a Modbus Register (eg. HR or CS) to a Modbus Slave.
Register Type	Modbus Register Type: CS – Coil Status IS – Input Status IR – Input Register HR – Holding Register
Local Reg.	The local PLX51-DNPS Modbus address.
Count	The number of Modbus elements to read or write.
Remote Reg.	The remote slave Modbus address.
IP Address	The IP address of the remote Modbus TCP slave.
Node	The Modbus Node address of the remote Modbus slave.
Reformat	How the data is formatted before reading or writing from/to the Modbus slave. None – No reformatting will be done. BB AA – 16bit Byte swap BB AA DD CC – 32bit Byte Swap CC DD AA BB – Word Swap DD CC BB AA – Word and Byte Swap

Table 3.8 - Modbus Auxiliary Map configuration parameters

3.4.10 Advanced

The *Advanced* configuration is shown in the figure below.

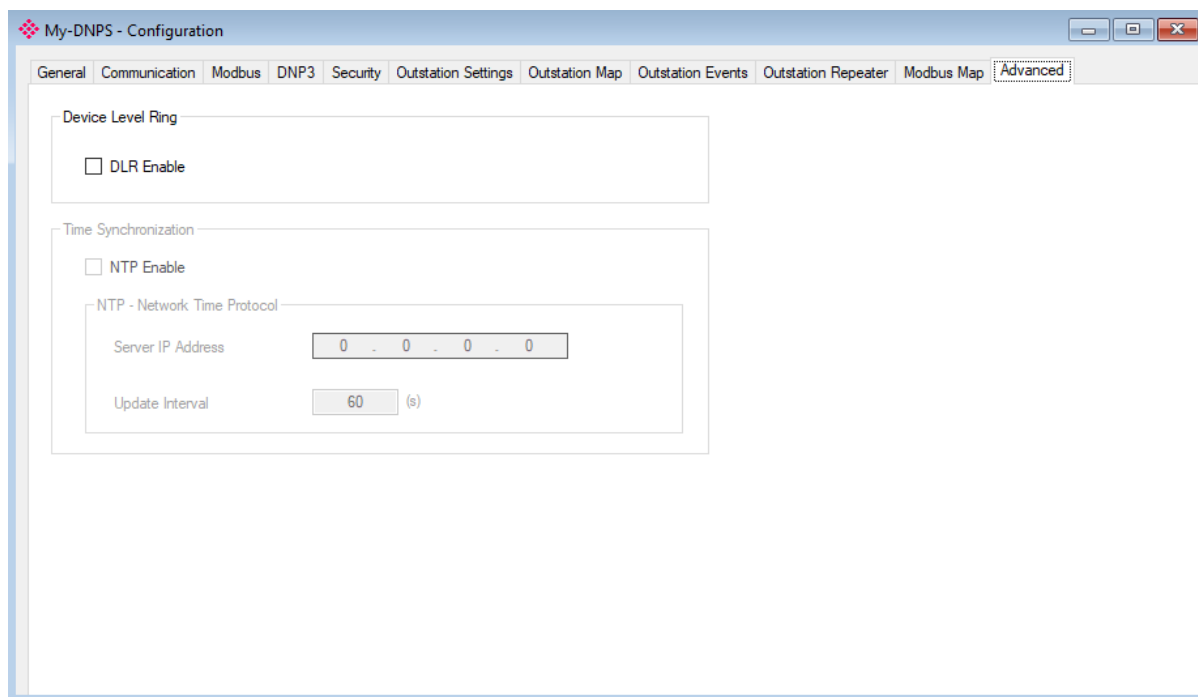

Figure 3.23 – Advanced configuration

The Advanced configuration consists of the following parameters:

Parameter	Description
DLR Enable	This must be set to enable Device Level Ring operation when the PLX51-DNPS will be operating in an Ethernet DLR.
NTP Enable	N/A
NTP – Server IP Address	N/A
NTP – Update Interval	N/A

Table 3.9 - Advanced configuration parameters

3.5 Message Routing

3.5.1 Outstation Map

The Outstation routing mode allows mapping of virtual Data Files to Logix tags or Modbus registers.

If the **Operating Interface** is set to EtherNet/IP, then the module will transform the DNP3 message into a tag read or write action to a Logix controller at a preconfigured path.

If the **Operating Interface** is set to CIP USB, then the module will transform the DNP3 message into a tag read or write action to a Logix controller using a USB connection. NOTE: The PLX51-DNPS will need to be directly connected to the Logix controller USB port.

If the **Operating Interface** is set to Modbus, then the module will transform the DNP3 message into a Modbus register read or write function.

Outstation Map - EtherNet/IP

The routing of the DNP3 group, variation, and range to a Logix Controller tag is managed by the PLX51-DNPS and operates completely independently of the Logix controller by reading and writing to Logix tags.

IMPORTANT: The PLX51-DNPS supports Read, Write, Select, Operate, Direct-Operate, Direct-Operate-No-Response, Freeze, Freeze-NR, Freeze and Clear, Freeze and Clear-NR, Assign Class, and Secure Authentication functions.

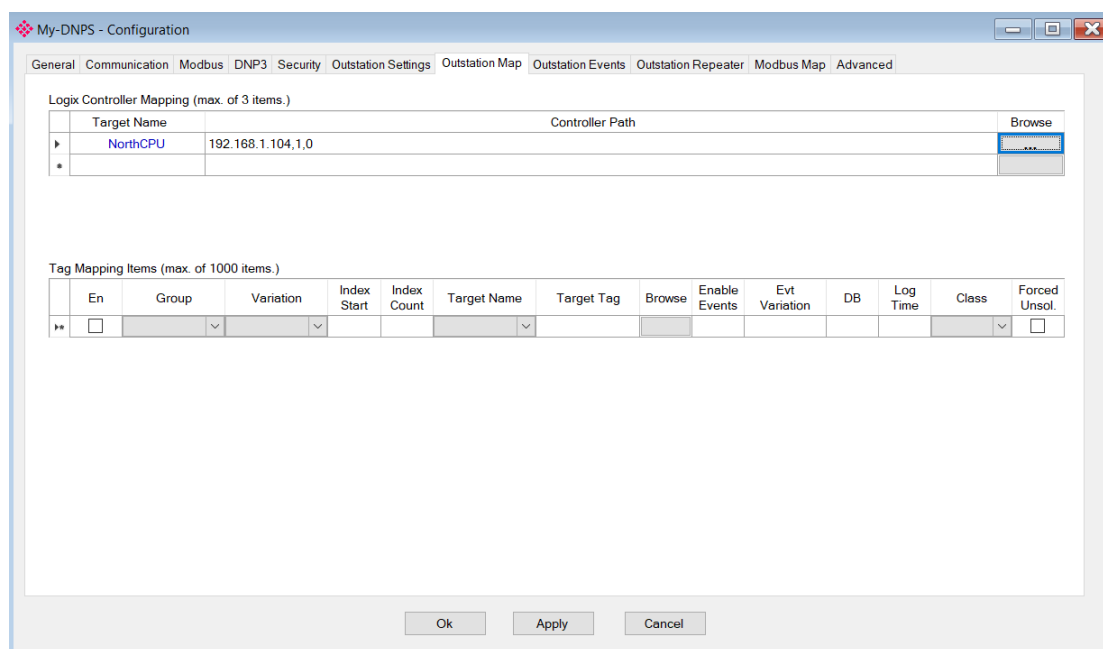

Figure 3.24 - Outstation mode with EtherNet/IP

The Outstation mapping is configured in two steps. First, you must create a **Target Name** (CIP path to the destination Logix controller) which will be used to link the DNP3 group, variation, and range to the destination Logix tag.

The Logix controller paths can be either entered manually or you can browse to them by clicking the **Browse** button. The **Target Browser** will open and automatically scan for all available EtherNet/IP devices.

If the Ethernet/IP module is a bridge module, it can be expanded to reveal the underlying backplane.

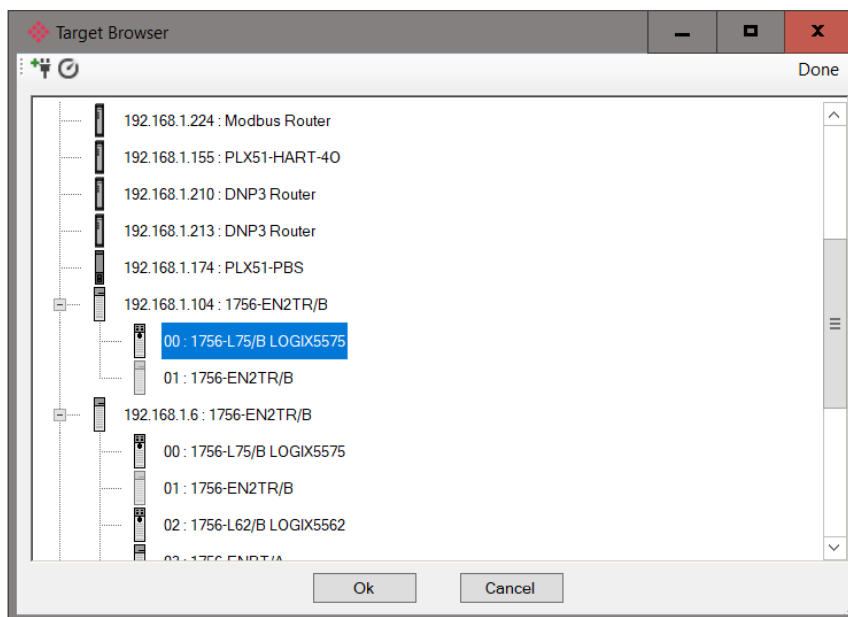

Figure 3.25 - Target Browser selection

The required Logix controller can then be chosen by selecting it and clicking the **Ok** button, or by double-clicking on the controller module.

A maximum number of 3 controller mapping entries can be added.

The second part of the configuration is to configure the link between a DNP3 group, variation, and range combination to a Logix tag. This will allow the DNP3 message initiator to effectively write to, or read from, a Logix tag using traditional DNP3 functions (e.g. Select/Operate).

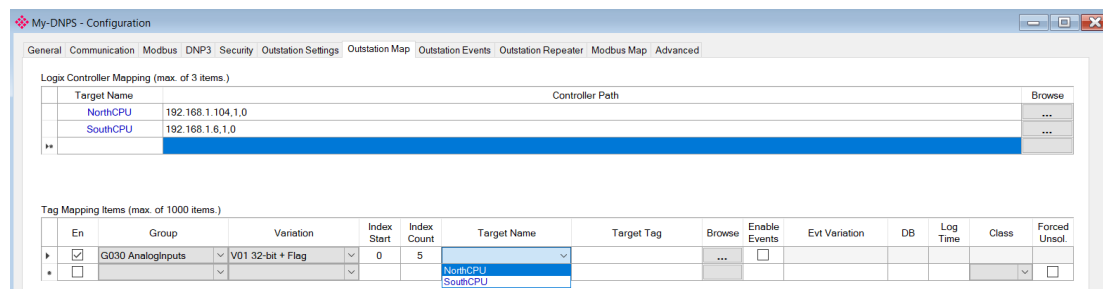

Figure 3.26 – Outstation tag mapping

DNP3 allows you to select from a range of different formats (called variations) for each group. This will allow you to access additional information for a specific group (e.g. timestamp, status, etc.). For this reason, you must use or match the example UDTs to access the all data in the Logix controller.

IMPORTANT: The example UDTs provided must be used to map the data in the Logix Controller when DNP3 variations are chosen which allow for additional information, that is, non-standard Logix atomic data types. If these UDTs are not used, you risk using the exchanged data incorrectly. Refer to the DNP3 Operation section for further information.

Next, the range of data to be accessed must be specified. This is done by selecting a start index as well as the index count which is the number of elements that you need to access.

Below is an example of the target tag selection. The Target Tag can be either entered manually or selected using the **Tag Browser** in PLX50 Configuration Utility. The **Tag Browser** requires the controller to be available on the network.

To browse to the tag, click on the **Browse** button. The **Tag Browser** will open and scan all the tags inside that controller. If the controller has been recently scanned in this PLX50 Configuration Utility session, then a cached version of the tags will be displayed. A rescan of the tags can be triggered by selecting the **Refresh** button in the **Tag Browser's** toolbar.

Only tags of a relevant type will be enabled, guiding you to select a suitable tag.

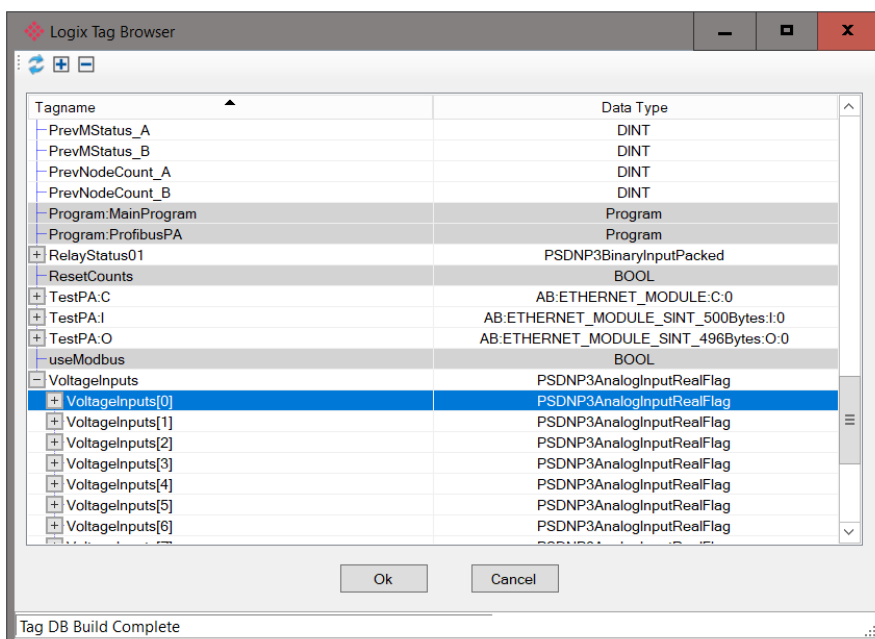

Figure 3.27 – Tag Browser tag selection

The figure below is an example of how DNP3 messages are routed to the Logix tags using the Outstation mode.

IMPORTANT: It is your responsibility to ensure that the Logix tag datatype/UDT and size matches that of the DNP3 message requests. Failing to do this can cause unexpected results and communication faults. A list of recommended data types for each Group – Variant combination is listed in Appendix A.

Example 1

Logix Controller Mapping

Target Name	Controller Path	Browse
NorthCPU	192.168.1.104,1,0	...
SouthCPU	192.168.1.6,1,0	...

Logix Tag Mapping

Group	Variation	Index Start	Index Count	Target Name	Target Tag	Browse	Enable Events	Event Variation	DB
G030 AnalogInputs	V01 32-bit + Flag	0	5	NorthCPU	VoltageInputs[0]	...	<input type="checkbox"/>		
G001 BinaryInputs	V01 Packed	0	20	SouthCPU	LevelSwitches[0]	...			

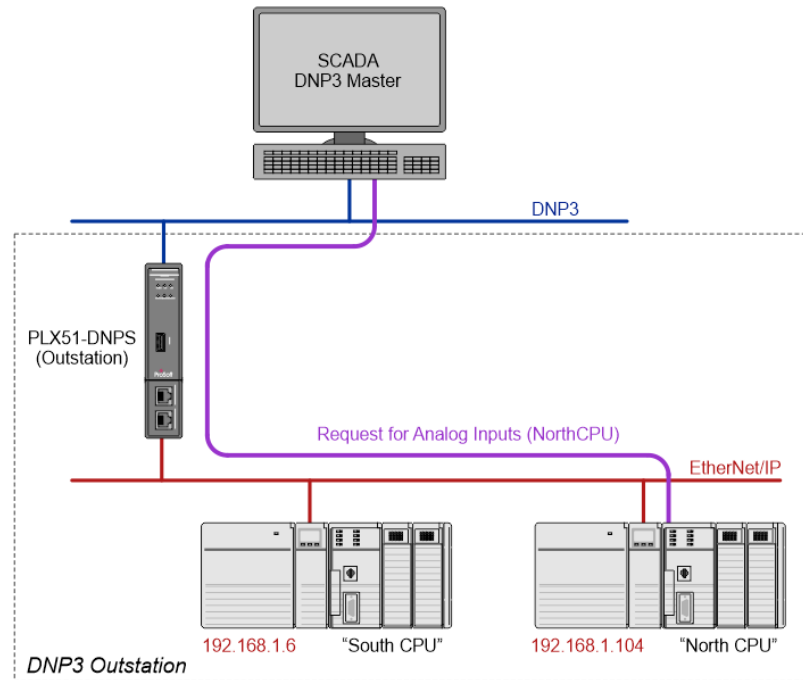

Figure 3.28 - Outstation mode configuration (Example map 1)

Example 2

Logix Controller Mapping

Target Name	Controller Path	Browse
NorthCPU	192.168.1.104,1,0	...
SouthCPU	192.168.1.6,1,0	...

Logix Tag Mapping

Group	Variation	Index Start	Index Count	Target Name	Target Tag	Browse	Enable Events	Event Variation	DB
G030 AnalogInputs	V01 32-bit + Flag	0	5	NorthCPU	VoltageInputs[0]	...	<input type="checkbox"/>		
G001 BinaryInputs	V01 Packed	0	20	SouthCPU	LevelSwitches[0]	...			

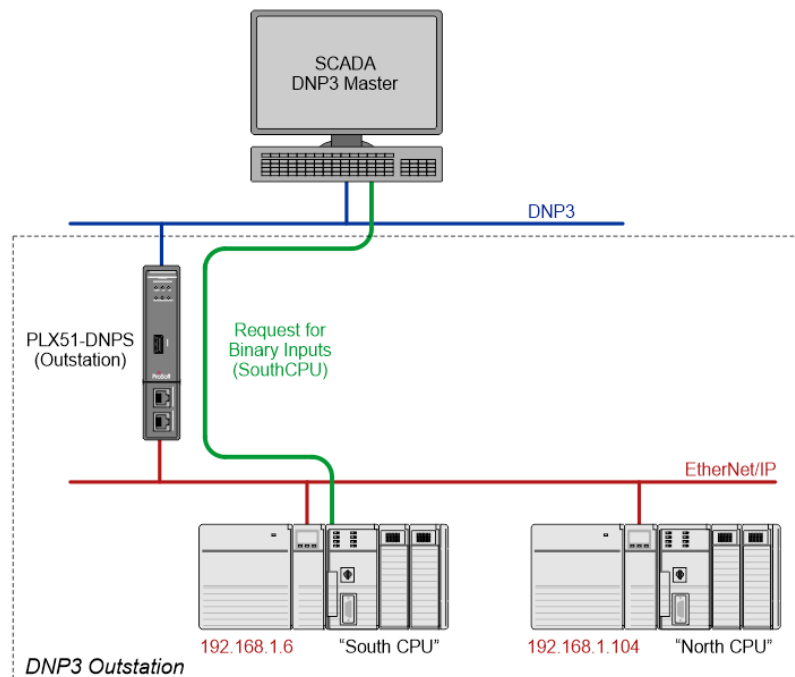

Figure 3.29 - Outstation mode configuration (Example map 2)

When using operate commands, you will always need a tag for the operate command as well as a tag for the status. For example, when using Binary Commands (switching a binary value on or off) the Binary Control Group 12 will need to be used. This group is an operate-only group and does not contain or hold any value. The value received via the Command Group must then be copied to the Status Group 10 in the Logix controller (as shown in the diagram below). This is a read-only group and is used by the DNP3 Master to monitor the status and actual value of the outputs. The same must be done for Analog Output Commands and Status Groups. See the following example:

Group	Variation	Index Start	Index Count	Target Name	Target Tag	Browse	Enable Events	Event Variation	DB
G010 BinaryOutputs	V02 Output Status + Flags	0	10	NorthCPU	DNP3G10V02[0]	...	<input type="checkbox"/>		
G012 BinaryOutputCommands	V01 CROB	0	10	NorthCPU	DNP3G12V01[0]	...	<input type="checkbox"/>		
G040 AnalogOutputStatus	V03 Single Float + Flag	0	10	NorthCPU	DNP3G40V03[0]	...	<input type="checkbox"/>		
G041 AnalogOutputs	V03 Single Float	0	10	NorthCPU	DNP3G41V03[0]	...	<input type="checkbox"/>		

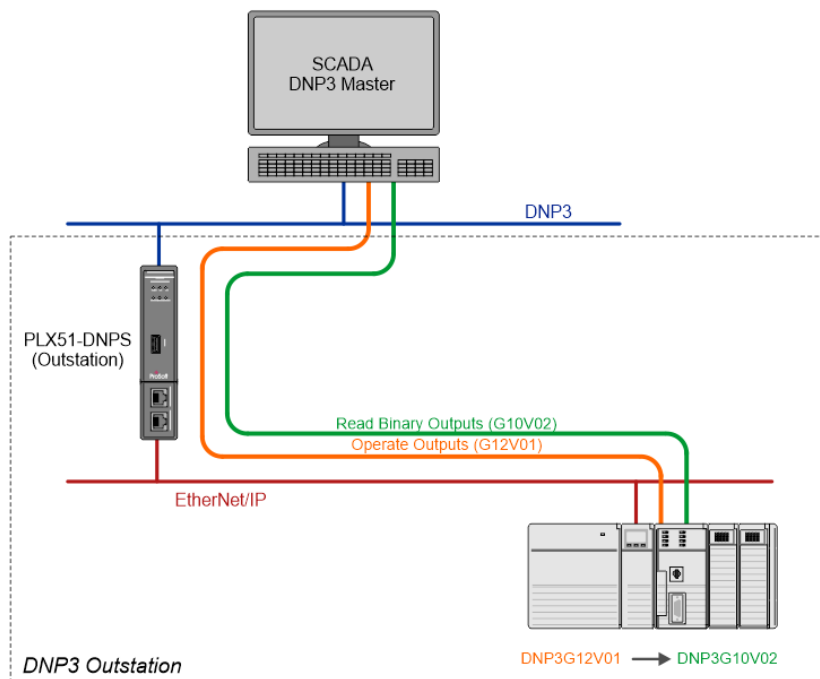

Figure 3.30 – DNP3 Commands configuration and operation

Outstation Map – CIP USB

The routing of the DNP3 group, variation, and range to a Logix Controller tag is managed by the PLX51-DNPS and operates completely independently of the Logix controller by reading and writing to Logix tags.

IMPORTANT: The PLX51-DNPS supports Read, Write, Select, Operate, Direct-Operate, Direct-Operate-No-Response, and Secure Authentication functions.

IMPORTANT: The PLX51-DNPS must be directly connected to the Logix controller (via USB) when the operating is set to CIP USB.

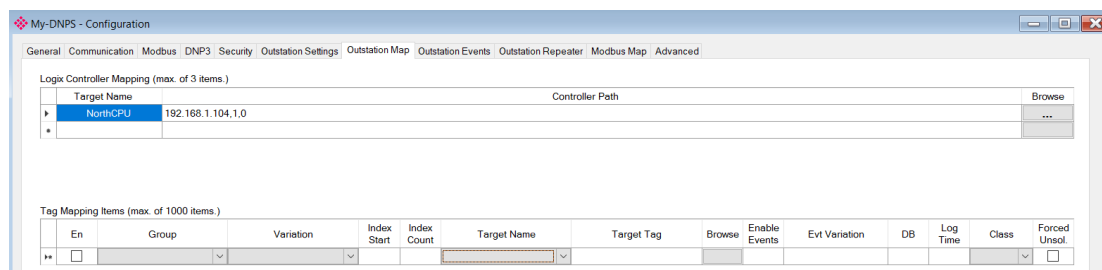

Figure 3.31 - Outstation mode with CIP USB

The Outstation mapping is configured in two steps. First, you must create a **Target Name** (CIP path to the destination Logix controller). This will be used to allow the PLX50CU to browse the destination controller for tags to be used. It is not used by the PLX51-DNPS for message routing because the USB is directly connected.

IMPORTANT: The user **does not** need to enter the Logix Controller path in the mapping, because the PLX51-DNPS is directly connected to the Logix Controller (via USB). The Logix Controller Path will **only** be used for browsing the tags of the Logix Controller when connected on the same network.

IMPORTANT: The user will need to ensure that if a Controller is being scanned for tags, that the CIP Path entered is to the same Logix Controller directly connected to the PLX51-DNPS (via USB).

The Logix controller paths can be either entered manually or you can browse to them by clicking the **Browse** button. The **Target Browser** will open and automatically scan for all available EtherNet/IP devices.

If the Ethernet/IP module is a bridge module, it can be expanded to reveal the underlying backplane.

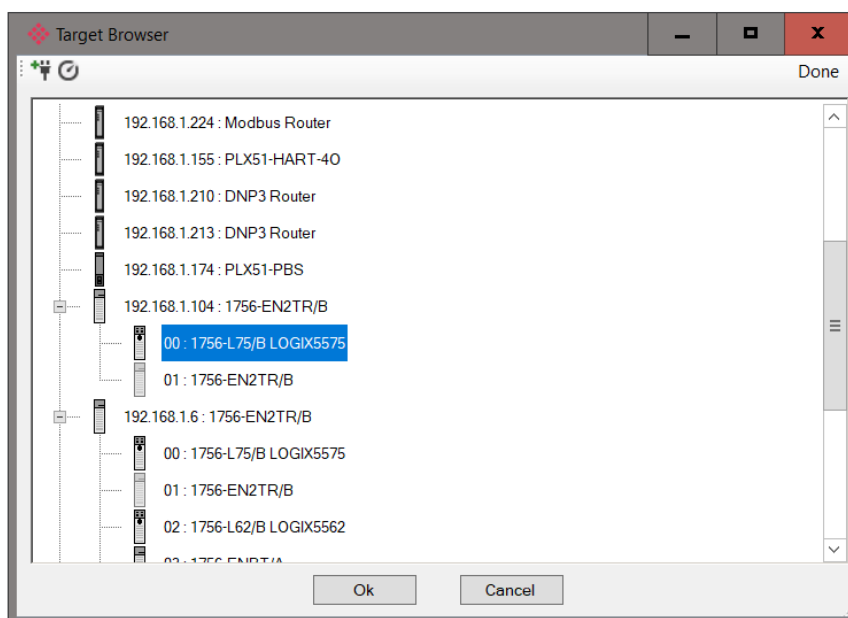

Figure 3.32 - Target Browser selection

IMPORTANT: The PLX51-DNPS can only communicate with a single Logix Controller when the operating interface is set to CIP USB.

The second part of the configuration is to configure the link between a DNP3 group, variation, and range combination to a Logix tag. This will allow the DNP3 message initiator to effectively write to, or read from, a Logix tag using traditional DNP3 functions (e.g. Select/Operate).

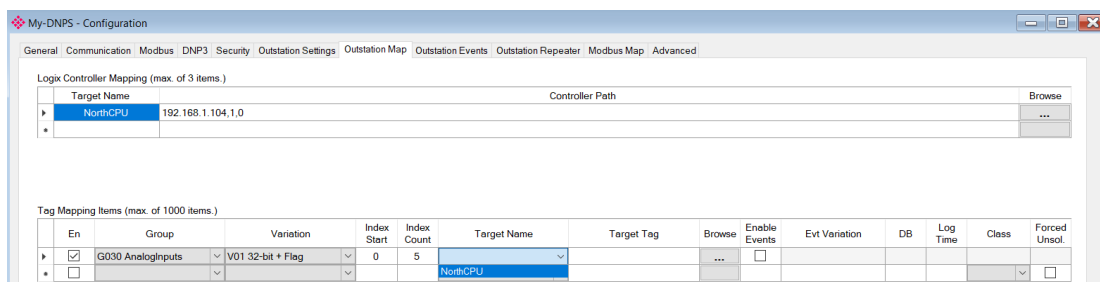

Figure 3.33 – Outstation tag mapping

DNP3 allows you to select from a range of different formats (called variations) for each group. This will allow you to access additional information for a specific group (e.g. timestamp, status, etc.). For this reason, you must use or match the example UDTs to access the all data in the Logix controller.

IMPORTANT: The example UDTs provided must be used to map the data in the Logix Controller when DNP3 variations are chosen which allow for additional information, that is, non-standard Logix atomic data types. If these UDTs are not used, you risk using the exchanged data incorrectly. Refer to the DNP3 Operation section for further information.

Next, the range of data to be accessed must be specified. This is done by selecting a start index as well as the index count which is the number of elements that you need to access.

Below is an example of the target tag selection. The Target Tag can be either entered manually or selected using the **Tag Browser** in PLX50 Configuration Utility. The **Tag Browser** requires the controller to be available on the network.

To browse to the tag, click on the **Browse** button. The **Tag Browser** will open and scan all the tags inside that controller. If the controller has been recently scanned in this PLX50 Configuration Utility session, then a cached version of the tags will be displayed. A rescan of the tags can be triggered by selecting the **Refresh** button in the **Tag Browser's** toolbar.

Only tags of a relevant type will be enabled, guiding you to select a suitable tag.

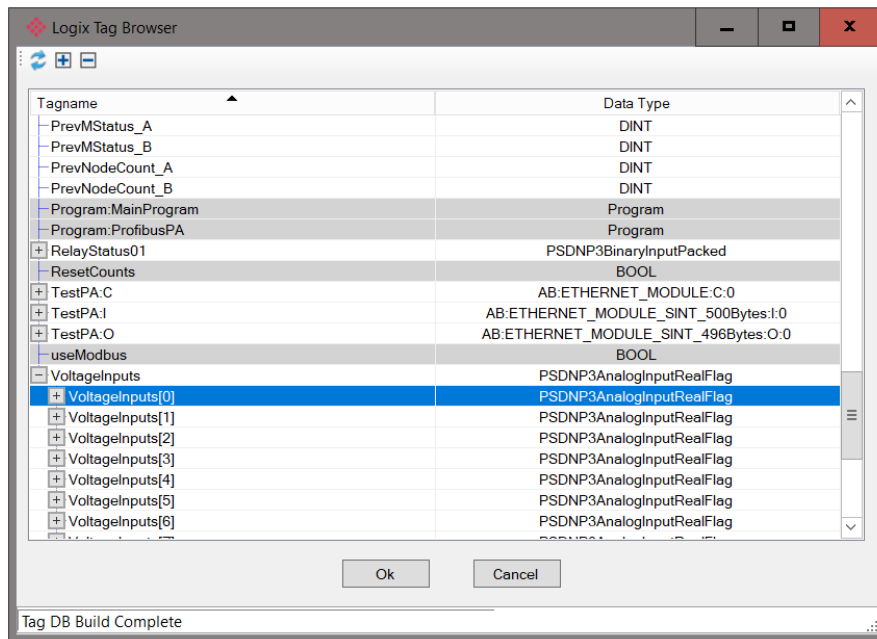

Figure 3.34 – Tag Browser tag selection

The figure below is an example of how DNP3 messages are routed to the Logix tags using the Outstation mode when using CIP USB Logix.

IMPORTANT: It is your responsibility to ensure that the Logix tag datatype/UDT and size matches that of the DNP3 message requests. Failing to do this can cause unexpected results and communication faults. A list of recommended data types for each Group – Variant combination is listed in Appendix A.

Example

Logix Controller Mapping

Target Name	Controller Path	Browse
NorthCPU	192.168.1.104,1,0	...

Logix Tag Mapping

Group	Variation	Index Start	Index Count	Target Name	Target Tag	Browse	Enable Events	Event Variation	DB
G030 AnalogInputs	V01 32-bit + Flag	0	5	NorthCPU	VoltageInputs[0]	...	<input type="checkbox"/>		
G001 BinaryInputs	V01 Packed	0	20	NorthCPU	LevelSwitches[0]	...	<input type="checkbox"/>		

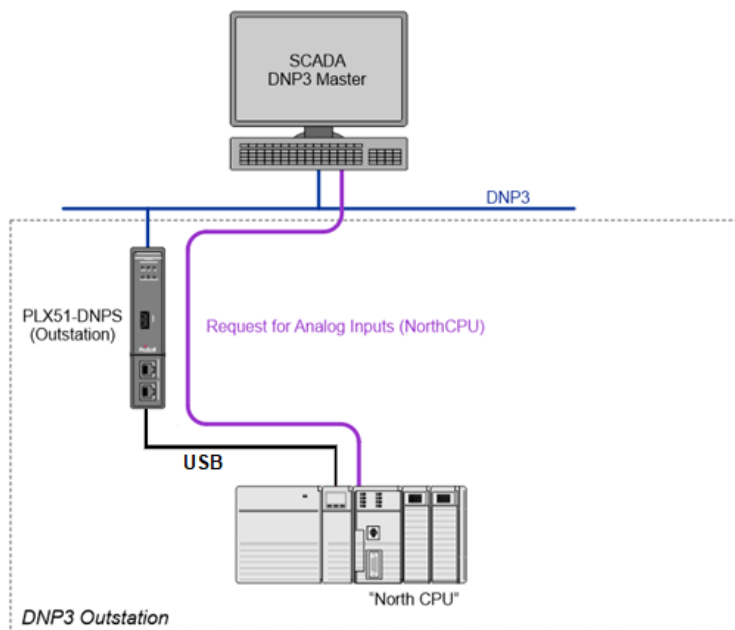

Figure 3.35 - Outstation mode configuration (Example map 1)

When using operate commands, you will always need a tag for the operate command as well as a tag for the status. For example, when using Binary Commands (switching a binary value on or off) the Binary Control Group 12 will need to be used. This group is an operate-only group and does not contain or hold any value. The value received via the Command Group must then be copied to the Status Group 10 in the Logix controller (as shown in the diagram below). This is a read-only group and is used by the DNP3 Master to monitor the status and actual value of the outputs. The same must be done for Analog Output Commands and Status Groups. See the following example:

Group	Variation	Index Start	Index Count	Target Name	Target Tag	Browse	Enable Events	Event Variation	DB
G010 BinaryOutputs	V02 Output Status + Flags	0	10	NorthCPU	DNP3G10V02{0}	...	<input type="checkbox"/>		
G012 BinaryOutputCommands	V01 CROB	0	10	NorthCPU	DNP3G12V01{0}	...	<input type="checkbox"/>		
G040 AnalogOutputStatus	V03 Single Float + Flag	0	10	NorthCPU	DNP3G40V03{0}	...	<input type="checkbox"/>		
G041 AnalogOutputs	V03 Single Float	0	10	NorthCPU	DNP3G41V03{0}	...	<input type="checkbox"/>		

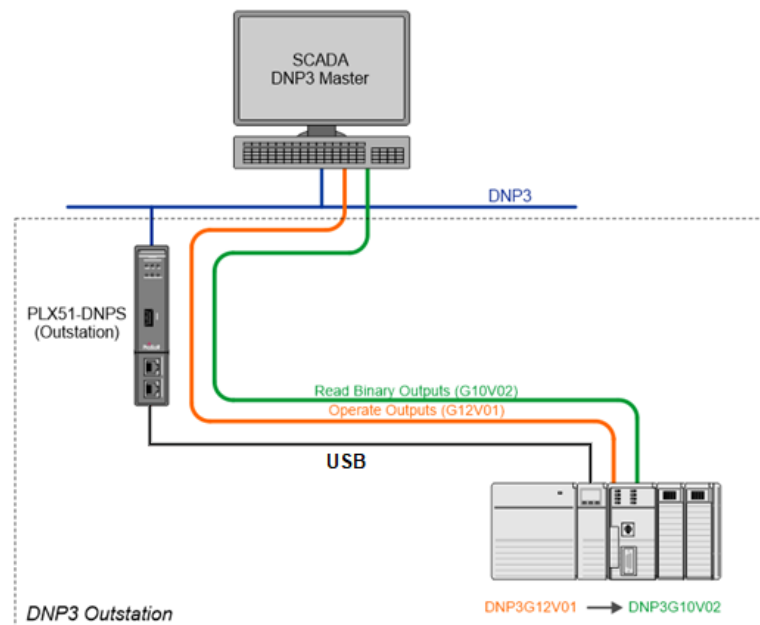

Figure 3.36 – DNP3 Commands configuration and operation

Outstation Map - Modbus

With the Operating Interface set to Modbus (Master or Slave), the routing of the DNP3 group, variation, and range will be mapped to internal Modbus registers.

In the case of the module being set as a Modbus Slave, a remote Modbus master must be configured to read and write the configured registers.

In the case of the module being configured as a Modbus Master, it is your responsibility to configure the Modbus Auxiliary Map which will transfer the information contained within the module’s internal Modbus registers to one or more external Modbus slave devices.

IMPORTANT: The PLX51-DNPS supports Read, Write, Select, Operate, Direct-Operate, Direct-Operate-No-Response, and Secure Authentication functions.

When using Modbus, the **Controller Mapping** table is not relevant and can be ignored.

The **Modbus Mapping Items** table is used to configure the link between a DNP3 group, variation, and range combination and a Modbus Register. This will allow the DNP3 message initiator to effectively write to, or read from, an internal Modbus register using traditional DNP3 functions (e.g. Select/Operate).

Controller Mapping (Disabled)

Target Name	Controller Path	Browse
*		

Modbus Mapping Items (max. of 1000 items.)

Group	Variation	Index Start	Index Count	Register Type	Modbus Offset	Enable Events	Event Variation	DB
G030 AnalogInputs	V01 32-bit + Flag	0	5	HR	500	<input type="checkbox"/>		
>>								

Figure 3.37 – Outstation Modbus mapping

DNP3 allows you to select from a range of different formats (called variations) for each group. This will allow you to access additional information for a specific group (e.g. timestamp, status, etc.). The DNP3 data will be automatically padded to match the 16-bit nature of Modbus.

Next the range of data to be accessed must be specified. This is done by selecting a start index as well as the index count which is the number of elements that you need to access.

An appropriate Modbus Register Type (HR, IR, CS or IS) in relation to the DNP3 object type should be selected. The Modbus Offset is the starting register address of the DNP3 object's data.

The DNP3 data will be formatted as shown below for Modbus Registers.

DNP3 Group	DNP3 Variation	DNP3 Description	Modbus Format
1	1	Packed	No Padding
1	2	+ Flags	1 Byte Data&Flag + 1 Byte Pad NOTE: Byte Padding will only be applied for IR and HR register types.
3	1	Packed	No Padding
3	2	+ Flags	1 Byte Data&Flag + 1 Byte Pad NOTE: Byte Padding will only be applied for IR and HR register types.
10	1	Packed	No Padding
10	2	Status + Flags	1 Byte Data&Flag + 1 Byte Pad NOTE: Byte Padding will only be applied for IR and HR register types.
12	1	CROB	2 Bytes Receive Flag + 11 Bytes Data + 1 Byte Pad NOTE: The receive flag Bit 0 is used to indicate to the Controller that a new operate command has been received.
20	1	32bit + Flag	1 Byte Flag + 1 Byte Pad + 4 Bytes Data + 2 Byte Frozen Flag + 6 Byte Time
20	2	16bit + Flag	1 Byte Flag + 1 Byte Pad + 2 Bytes Data + 2 Byte Frozen Flag + 6 Byte Time
20	5	32bit + No Flag	4 Bytes Data + 2 Byte Frozen Flag + 6 Byte Time
20	6	16bit + No Flag	2 Bytes Data + 2 Byte Frozen Flag + 6 Byte Time
21	1	32bit + Flag	1 Byte Flag + 1 Byte Pad + 4 Bytes Data
21	2	16bit + Flag	1 Byte Flag + 1 Byte Pad + 2 Bytes Data
21	5	32bit + Flag + Time	1 Byte Flag + 1 Byte Pad + 4 Bytes Data + 6 Bytes Time

21	6	16bit + Flag + Time	1 Byte Flag + 1 Byte Pad + 2 Bytes Data + 6 Bytes Time
21	9	32bit + No Flag	No Padding
21	10	16bit + No Flag	No Padding
30	1	32bit + Flag	1 Byte Flag + 1 Byte Pad + 4 Bytes Data
30	2	16bit + Flag	1 Byte Flag + 1 Byte Pad + 2 Bytes Data
30	3	32bit + No Flag	No Padding
30	4	16bit + No Flag	No Padding
30	5	Float + Flag	1 Byte Flag + 1 Byte Pad + 4 Bytes Data
40	1	32bit + Flag	1 Byte Flag + 1 Byte Pad + 4 Bytes Data
40	2	16bit + Flag	1 Byte Flag + 1 Byte Pad + 2 Bytes Data
40	3	Float + Flag	1 Byte Flag + 1 Byte Pad + 4 Bytes Data
41	1	32bit	2 Bytes Receive Flag + 4 Bytes Data + 1 Byte Control + 1 Byte Pad NOTE: The receive flag Bit 0 is used to indicate to the Controller that a new operate command has been received.
41	2	16bit	2 Bytes Receive Flag + 2 Bytes Data + 1 Byte Control + 1 Byte Pad NOTE: The receive flag Bit 0 is used to indicate to the Controller that a new operate command has been received.
41	3	Float	2 Bytes Receive Flag + 4 Bytes Data + 1 Byte Control + 1 Byte Pad NOTE: The receive flag Bit 0 is used to indicate to the Controller that a new operate command has been received.
102	1	8bit	1 Byte Data + 1 Byte Pad NOTE: Byte Padding will only be applied for IR and HR register types.
110	1	8bit	There is no padding for the octet strings. The string value will be read or written to the Modbus Registers on a per byte basis. Once the string ends a zero will be written to the last byte. This zero must be used as the delimiter for the string.

Table 3.10 – Modbus format for DNP3 group/variation Data

3.6 DNP3 Events

The PLX51-DNPS provides the ability to log various DNP3 elements and commands. The following parameters must be configured to enable DNP3 Events.

Parameter	Description
Enable Events	This parameter will enable or disable the DNP3 Event function for a specific set of DNP3 elements (configured in the same line item)
Event Variation	For each DNP3 Group there are various combinations of DNP3 Event variations that can be selected. These event variations will be used to log the default event format for when default event requests are used.
Deadband (DB)	The deadband is used to determine when to log an event for Counters, Analog Inputs, and Analog Outputs Status. If the value changes by more than the deadband an event is logged with the specific DNP3 element's value. NOTE: If dynamic configuration has been received from the DNP Master, then the deadbands will be overwritten based on the deadbands received by the DNP Master.
Log Time	The Log Time is used to determine how long (if the mapping has not logged) before the mapped item is logged. This time is in seconds. NOTE: If the event has been logged (for any other reason) then the log time will be reset back to zero. NOTE: A log time of zero will disable the time-based logging.
Class	The user can select an Event class per mapped item. When any of the DNP objects in the mapped items is logged it will be logged with the configured event class. If <i>Default</i> is selected, the <i>Outstation Default Event Classes</i> configuration will be applied to the group. NOTE: If dynamic configuration has been received from the DNP Master, then the class will be overwritten based on the class received by the DNP Master.
Force Unsol.	The user can enable unsolicited responses for each mapped item. NOTE: If the Force Target Address has not been enabled, the unsolicited responses will only become active once an enable or disable unsolicited responses command is received from the DNP Master. NOTE: If dynamic configuration has been received from the DNP Master, then the unsolicited responses will be overwritten based on the enabled/disabled unsolicited responses received by the DNP Master.

Table 3.11 – Event logging parameters

NOTE: DNP3 elements will always be logged when any status bit changes (e.g., Online, Restart, etc.).

NOTE: When using Binary Groups (e.g., Binary Inputs, Double Binary Inputs, and Binary Output Status elements) will be logged whenever there is a change in any value (status or process value).

NOTE: When using DNP3 Commands (e.g., Control Relay Output Block – CROB, or Analog Outputs) events will be logged when commands are received, thus the deadband or time log field is not applicable.

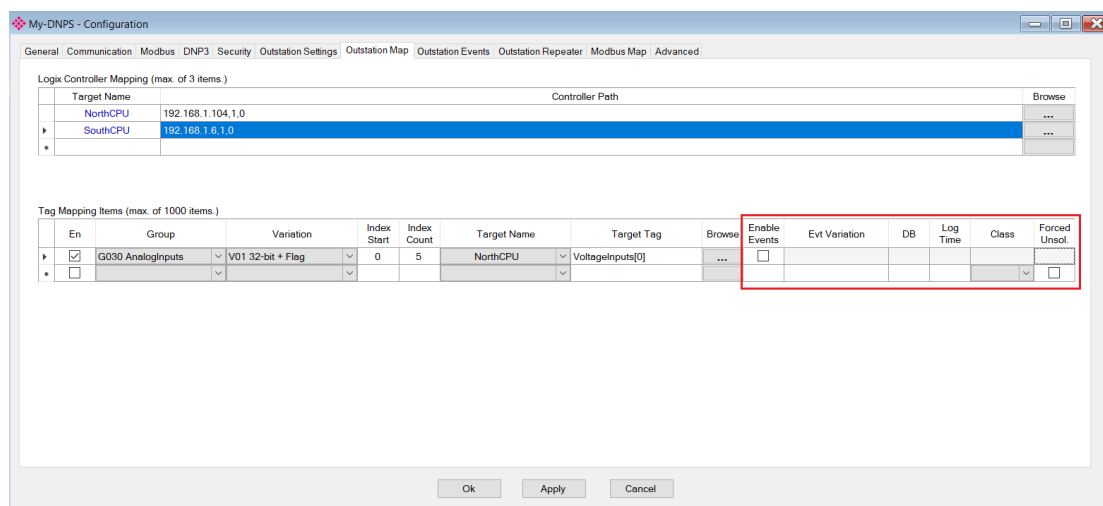

Figure 3.38 – DNP3 event selection

Each mapped line item will be read every 10ms from the Logix controller or Modbus Register. If a mapped line item is sufficiently large, then the reading of all the elements in the mapped line item will be spread over multiple Logix controller reads. In addition to the aforementioned Event trigger mechanism, it is also possible to **trigger events from Logix**. This allows the Logix application code to control when an event should be logged, which could be based on dynamic and individual deadbands, time intervals, other application conditions or any combination thereof.

Logix can trigger an event by changing the state of (the previously unused) Bit7 (**EventTrigger**) of the Status byte, as shown in the example UDT below:

Name	Value	Style	Data Type
VoltageInputs	{ ... }		PSDNP3AnalogInputRealFlag[20]
VoltageInputs[0]	{ ... }		PSDNP3AnalogInputRealFlag
VoltageInputs[0].Online	0	Decimal	BOOL
VoltageInputs[0].Restart	0	Decimal	BOOL
VoltageInputs[0].CommLost	0	Decimal	BOOL
VoltageInputs[0].RemoteForced	0	Decimal	BOOL
VoltageInputs[0].LocalForced	0	Decimal	BOOL
VoltageInputs[0].OverRange	0	Decimal	BOOL
VoltageInputs[0].ReferenceError	0	Decimal	BOOL
VoltageInputs[0].EventTrigger	0	Decimal	BOOL
VoltageInputs[0].Value	0.0	Float	REAL

Figure 3.39 – DNP3 Logix controlled event trigger example

NOTE: In the applicable DNP3 objects, Bit 7 is unused. Although used to trigger the logging of an event, this bit is masked off before being transmitted to the DNP3 master and thus complying with the DNP3 specification.

NOTE: The Logix triggered event mechanism requires the **Enable Events** parameter to be configured in the PLX50 Configuration Utility Logix Tag Mapping (above).

NOTE: The Outstation Logix example project (**DNP3OutstationExample**) includes Add-On-Instructions and examples where Logix triggers the event logging making use of dynamic deadbands, time intervals and external triggers.

IMPORTANT: When using the Logix controlled event trigger method, it is recommended to set the deadband (DB) in PLX50 Configuration Utility to a large value to avoid duplicate/unexpected events.

A maximum of 50,000 events can be logged per DNP3 Group Class.

Tag Mapping Items (max. of 1000 items.)

	En	Group	Variation	Index Start	Index Count	Target Name	Target Tag	Browse	Enable Events	Evt Variation	DB	Log Time	Class	Forced Unsol.
▶	<input checked="" type="checkbox"/>	G030 AnalogInputs	V05 Single Float + Flag	0	5	NorthCPU	VoltageInputs[0]	...	<input checked="" type="checkbox"/>	V05 Single Float No	1	0	Default	<input type="checkbox"/>
*	<input type="checkbox"/>									V05 Single Float No Time				<input type="checkbox"/>
										V07 Single Float + Time				<input type="checkbox"/>

Figure 3.40 – DNP3 event variation selection

3.7 Outstation Repeaters

The PLX51-DNPS provides the ability to repeat certain messages from and to certain DNP3 Outstations. This is particularly useful in radio networks where the DNP3 Master cannot see all the DNP3 Outstations. The PLX51-DNPS can also be configured to route certain messages to another PLX51-DNPS (over Ethernet) which will then repeat that message again on its serial network. This will allow you to have certain messages being routed and repeated to different radio networks, typically using different frequencies.

Below are three examples of repeater topologies in the PLX51-DNPS illustrating:

- Simple Repeater
- Redundant Repeater
- Routing

Simple Repeater

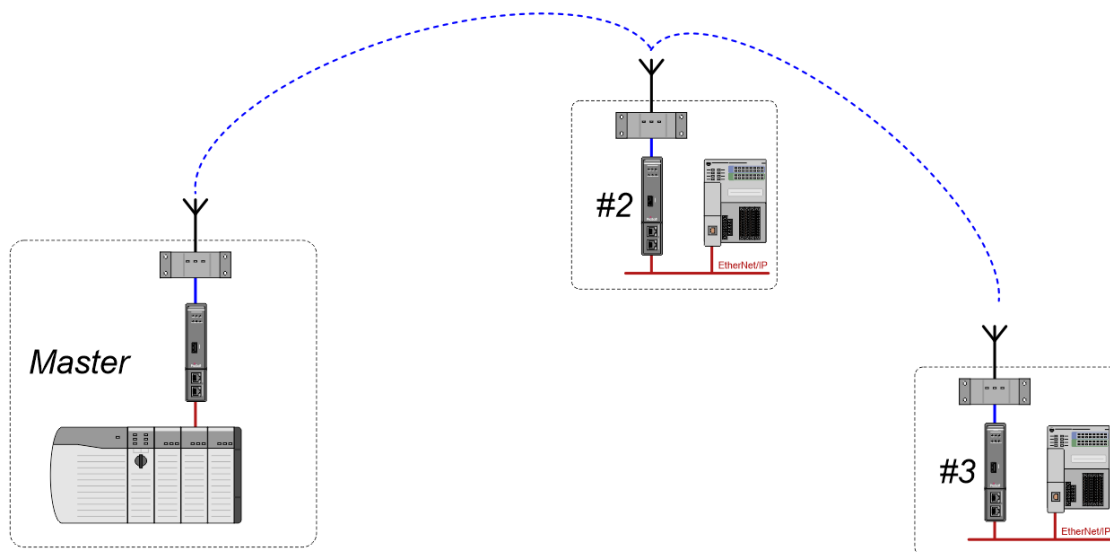

Figure 3.41 – Simple repeater example

Redundant Repeaters

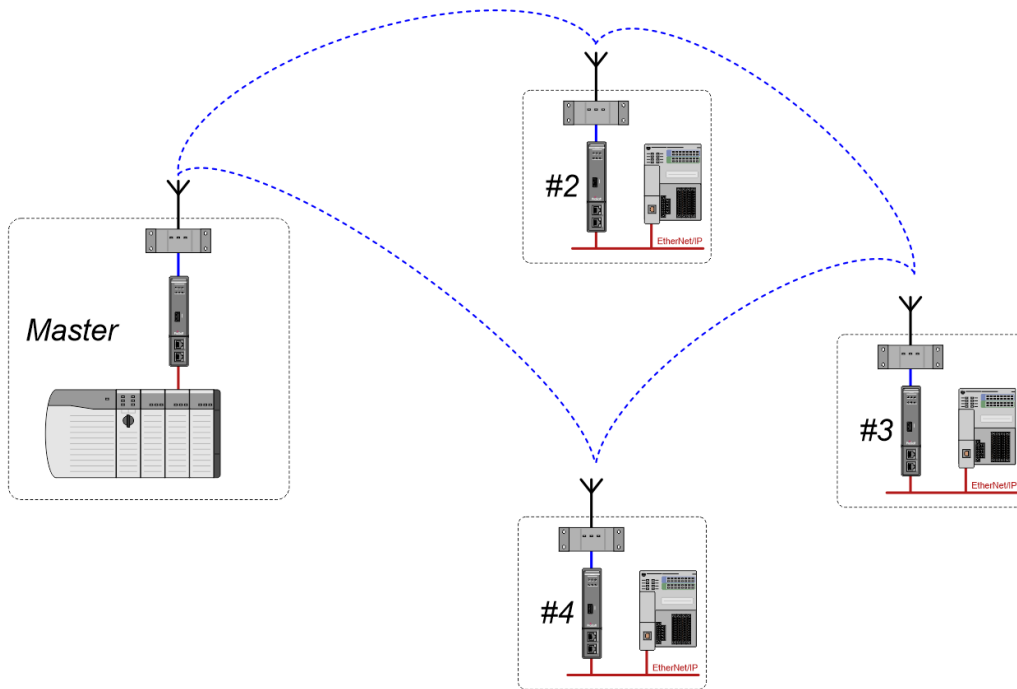

Figure 3.42 – Redundant repeater example

Routed Functionality

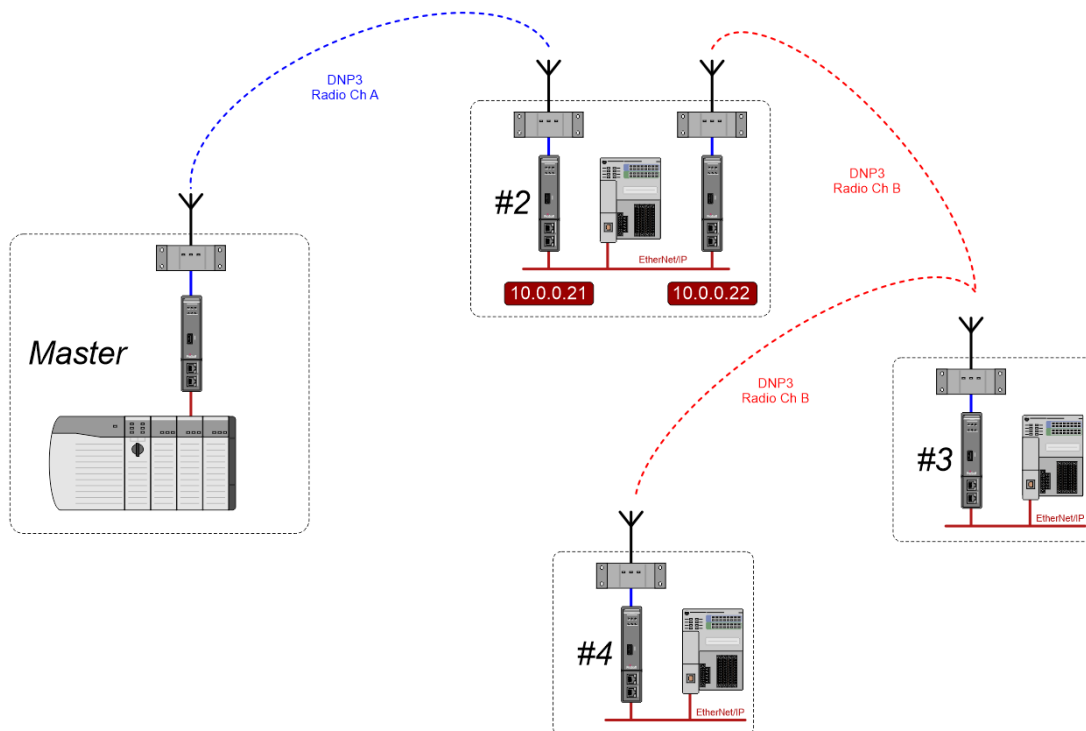

Figure 3.43 – Routed function example

3.8 Module Download

Once the DNP3 configuration has been completed, it must be downloaded to the module.

Before downloading the **Connection Path** of the module should be set. This path will automatically default to the IP address of the module, as set in the module configuration. It can however be modified should the PLX51-DNPS not be on a local network.

The Connection Path can be set by right-clicking on the module and selecting the **Connection Path** option.

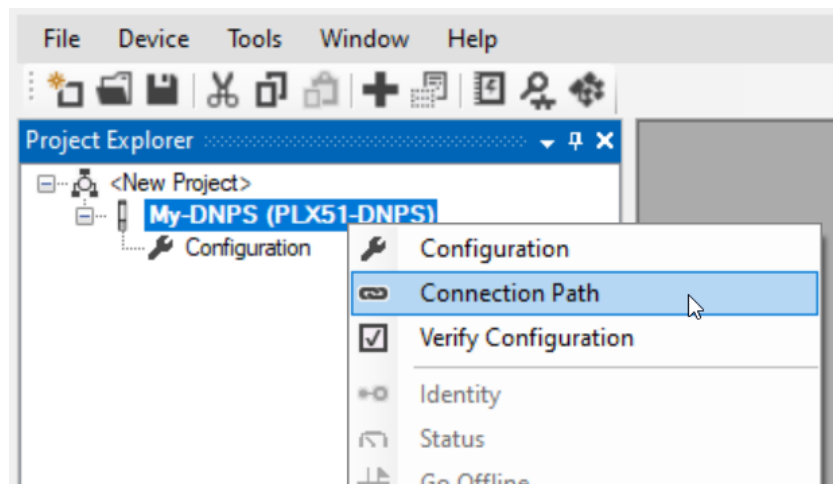

Figure 3.44 - Selecting Connection Path

The new connection path can then be either entered manually or selected by means of the **Target Browser**.

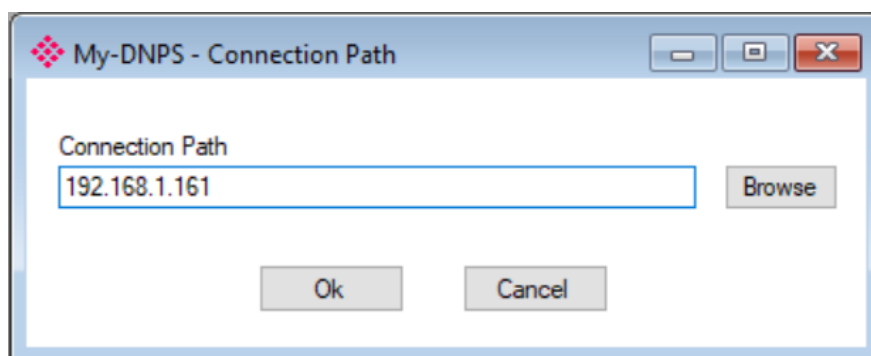

Figure 3.45 - Connection Path

To initiate the download, right-click on the module and select the **Download** option.

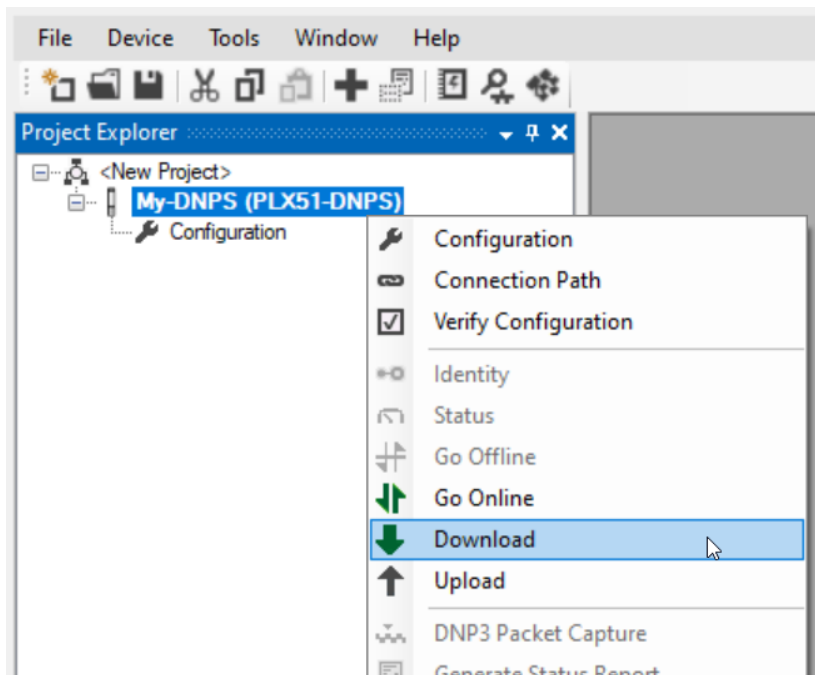

Figure 3.46 - Selecting Download

Once the download is complete, you will be notified that it was successful.

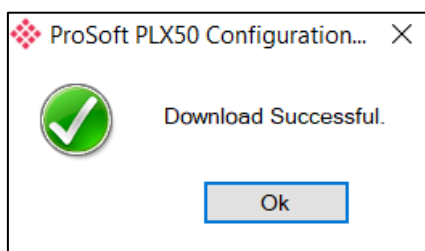

Figure 3.47 - Successful download

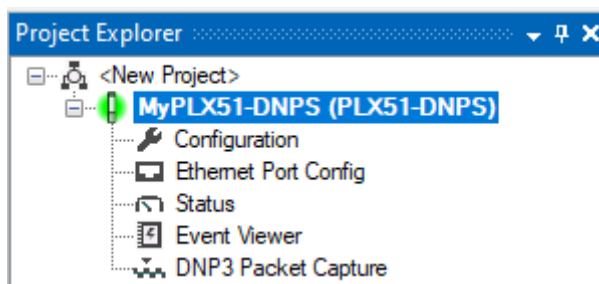

Figure 3.48 - Module online

3.9 RSLogix 5000 Configuration

The PLX51-DNPS modules can be easily integrated with Allen-Bradley Logix family of controllers.

For Logix versions 20 and beyond, the modules can be added using the EDS Add-On-Profile (AOP), which is described in section 3.9.1.

For older versions (19 and below), the module must be added using a Generic Profile which is described in section 3.9.2.

3.9.1 Studio 5000 Configuration (Version 20+)

Integration with the Logix family in Studio5000 makes use of the EDS AOP. Before the module can be added to the tree the module’s EDS file must be registered. Using RSLinx, the EDS file can be uploaded from the device after which the EDS Hardware Installation tool will be invoked to complete the registration.

Alternatively, the EDS file can be downloaded from the product webpage at: www.prosoft-technology.com and registered manually using the EDS Hardware Installation Tool shortcut under the Tools menu in Studio 5000.

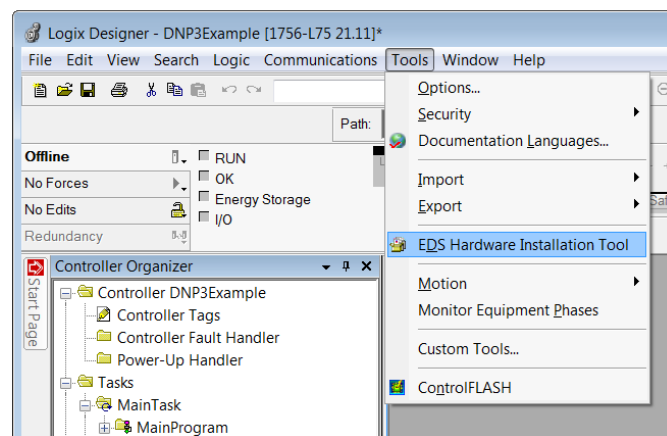

Figure 3.49 - EDS Hardware Installation Utility

After the EDS file has been registered, the module can be added to the Logix IO tree in Studio 5000. Under a suitable Ethernet bridge module in the tree, select the Ethernet network, right-click and select the New Module option.

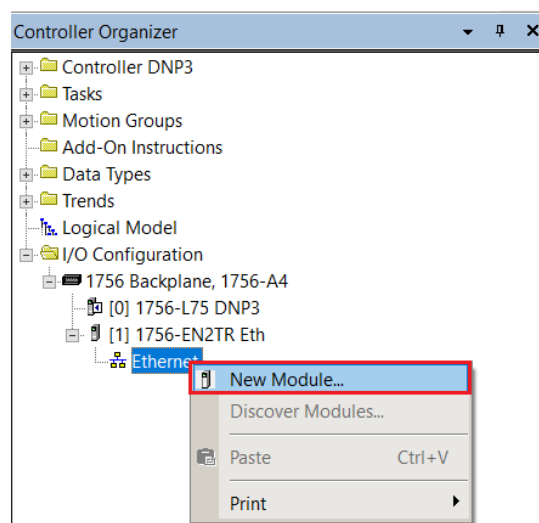

Figure 3.50 - Adding a module

The module selection dialog will open. To find the module more easily, use the Vendor filter to select only the ProSoft Technology modules as shown in the figure below.

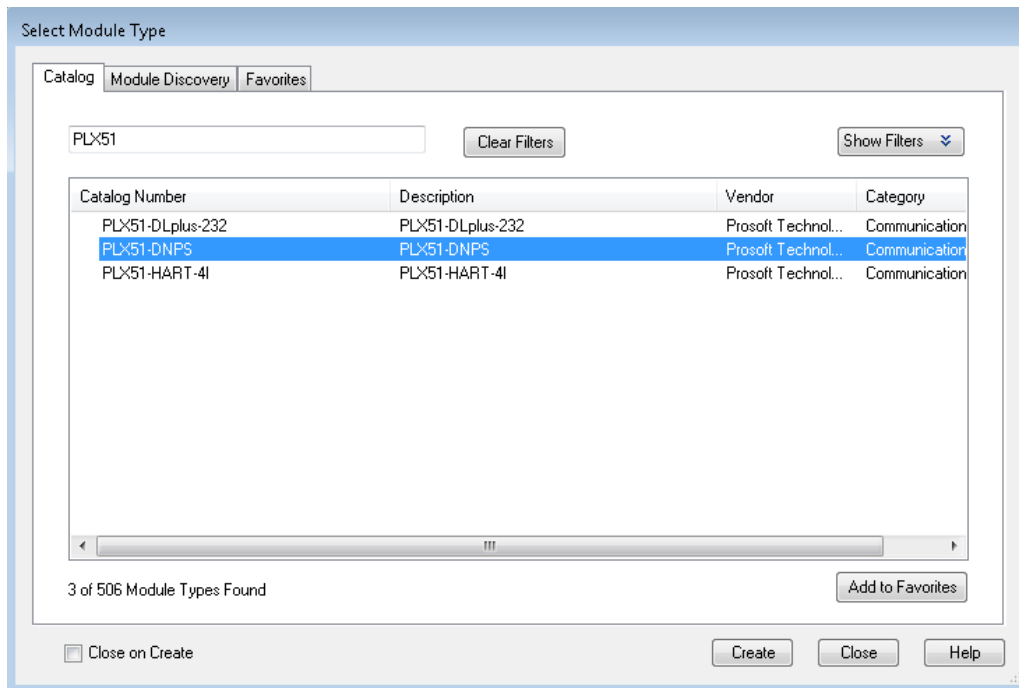

Figure 3.51 – Selecting the module

Locate and select the PLX51-DNPS module and select the **Create** option. The module configuration dialog will open, where you must specify the **Name** and **Ethernet Address** as a minimum to complete the instantiation.

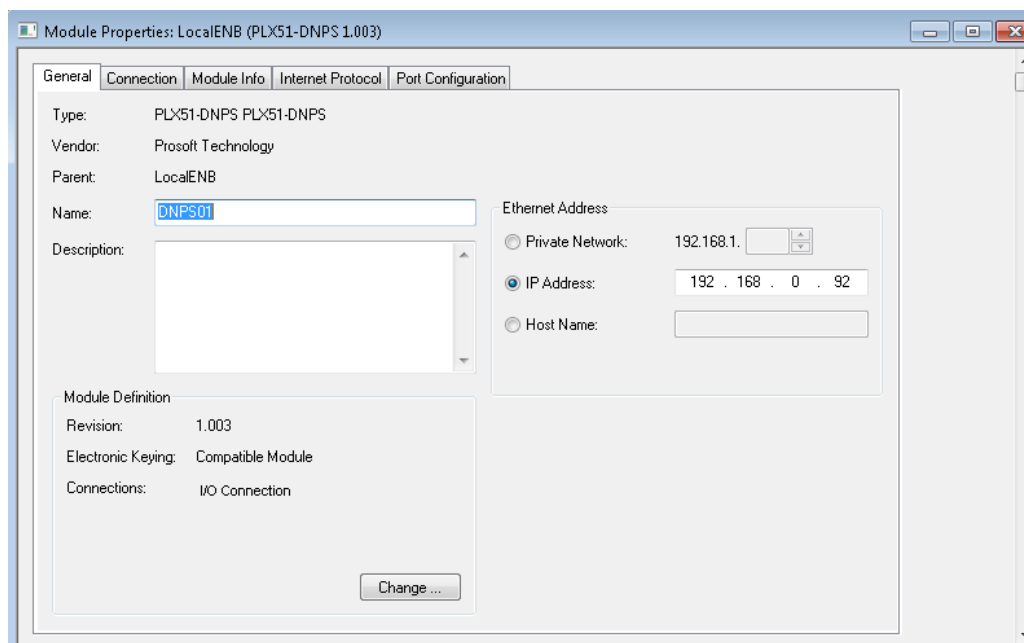

Figure 3.52 – Module instantiation

In the *Connection* tab, set the *Requested Packet Interval (RPI)*.

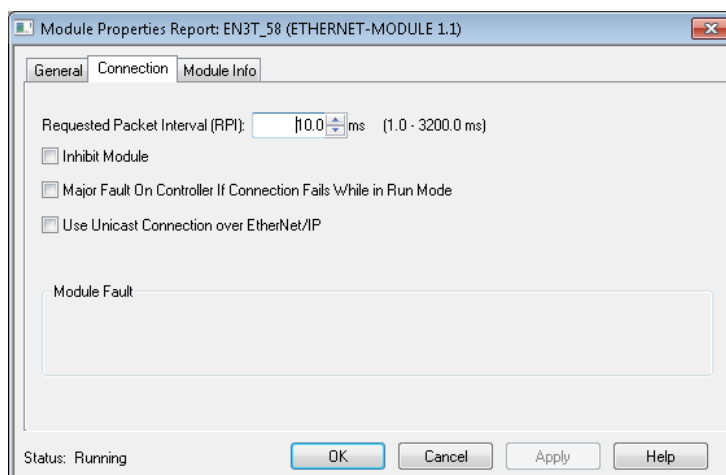

Figure 3.53 – Connection RPI

Once the instantiation is complete the module will appear in the Logix IO tree.

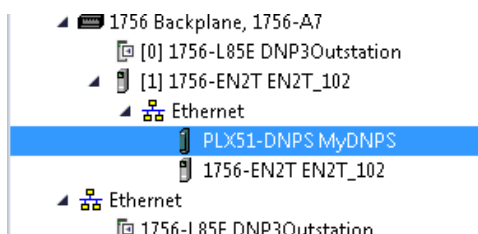

Figure 3.54 – Logix IO tree

The Module Defined Data Types will automatically be created during the instantiation process. These data types provide meaningful structures to the module data. An excerpt of the Input Image is shown in the following figure.

NOTE: The module defined data types are the data types required for the EtherNet/IP class 1 connection in the Logix IO tree. These data types do not include the data types required for the Logix DNP Objects (e.g., DNP 32bit Analog Input + Flag G30V01). The DNP object data types are provided in the example code and will need to be copied from the example code to the user’s application code.

▶ PLX51DNPSInput.Instance	'DNPS-EventsCLX'	{...}		STRING
▶ PLX51DNPSInput.Status		{...}	{...}	PLX51DNPSStatus
▶ PLX51DNPSInput.MasterMappedStatus		{...}	{...}	Decimal
▶ PLX51DNPSInput.TransactionRate		0		Decimal
▶ PLX51DNPSInput.Temperature		39.44635		Float
▶ PLX51DNPSInput.DNP3RxPacketCount		107		Decimal
▶ PLX51DNPSInput.DNP3TxPacketCount		0		Decimal
▶ PLX51DNPSInput.DNP3ChecksumErrors		0		Decimal
▶ PLX51DNPSInput.DNP3MsgTimeout		0		Decimal
▶ PLX51DNPSInput.AuthenticationFailures		0		Decimal
▶ PLX51DNPSInput.SessionKeyChanges		0		Decimal
▶ PLX51DNPSInput.TagReads		107		Decimal
▶ PLX51DNPSInput.TagWrites		0		Decimal
▶ PLX51DNPSInput.TagConnectionFailures		0		Decimal
▶ PLX51DNPSInput.TagErrors		0		Decimal
▶ PLX51DNPSInput.MasterEventBufferIndex		0		Decimal

Figure 3.55 – Module Defined Data Type

Importing DNP3 UDTs and AOIs

To assist with the Logix integration, AOI and UDTs can be imported using the provided Objects Routine Import. This is provided for Logix V21 where the user can upgrade the V21 project to the desired Logix revision.

The user can also use the example Logix code (ACD file) which is a stand-alone Logix example project for the PLX51-DNPS module. Both the routine import and stand-alone Logix files are available to download from the ProSoft website.

The import will create the required UDTs (user-defined data types) and AOIs (Add-On Instructions).

Below are the steps to import the AOIs and UDTs into a Logix project.

- 1 Right-click on the *MainProgram* and select *Add > Import Routine*.

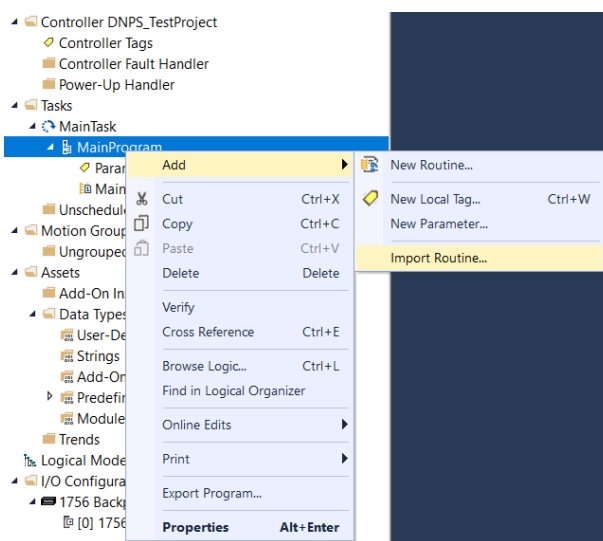

Figure 3.56 – Logix Routine Import

- 2 Select Object Routine Import for the DNPS module.

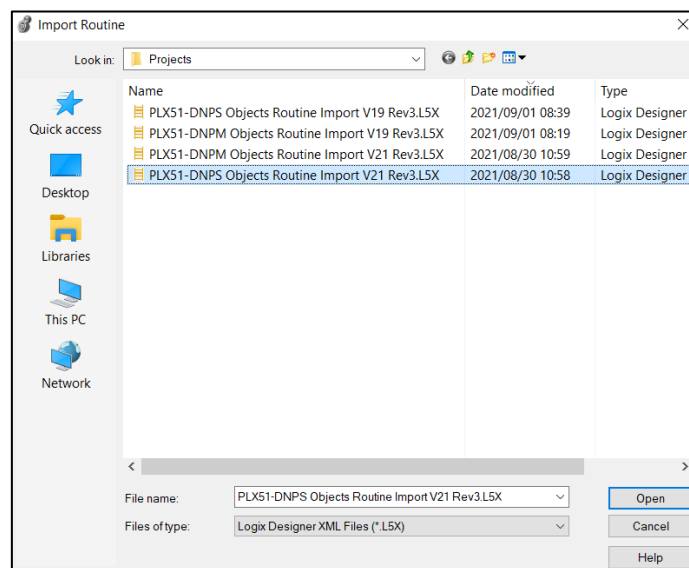

Figure 3.57 – Select .L5X file

3 Select **Ok** to create the required AOIs and UDTs.

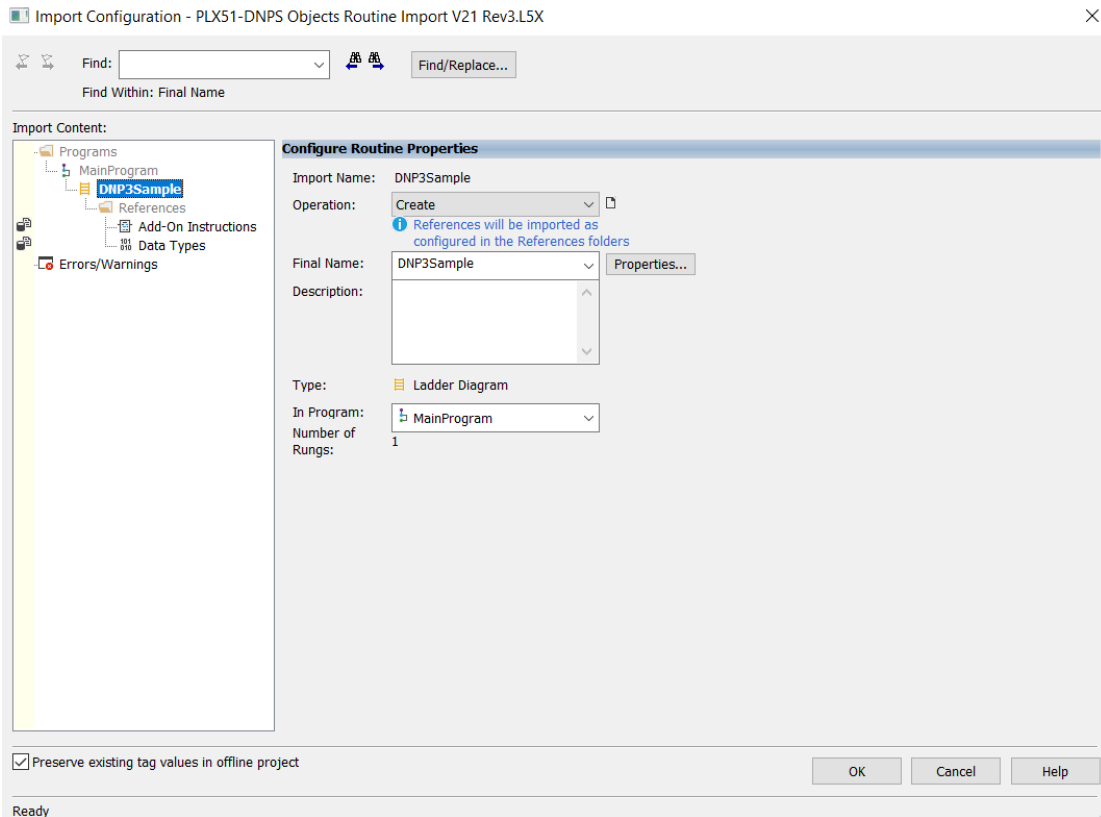

Figure 3.58 – Configure Routine Properties

A list of the imported Add-On Instructions and UDT's can be displayed as shown below.

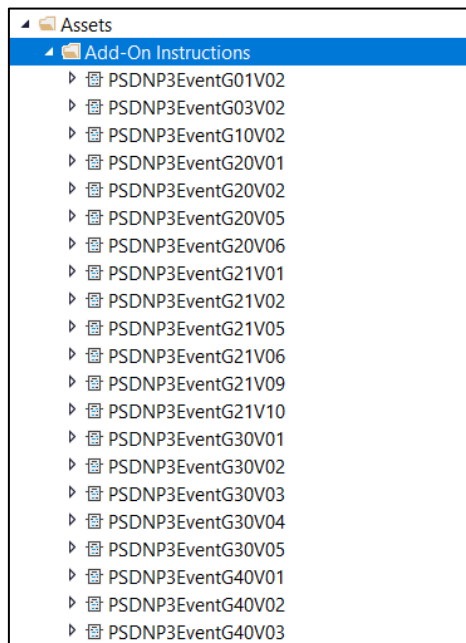

Figure 3.59 – Created AOIs

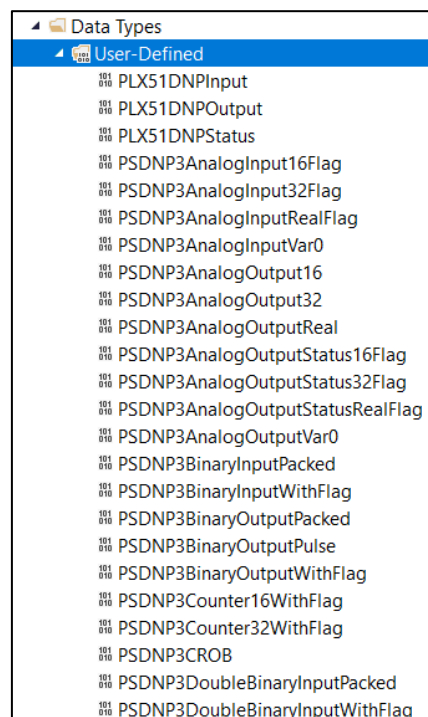

Figure 3.60 – Created UDTs

NOTE: Once the UDTs have been imported, the user will need to add the necessary Controller Tags (using the required UDTs) to exchange DNP3 data with the DNPS module.

3.9.2 RSLogix 5000 Configuration (Pre-Version 20)

Add Module to I/O Configuration

The module can operate in both a Logix “owned” and standalone mode. When the module operates in a Logix “owned” mode the PLX51-DNPS will need to be added to the RSLogix 5000 IO tree. The module will need to be added as a generic Ethernet module. This is done by right clicking on the Ethernet Bridge in the RSLogix 5000 and selecting *New Module* after which the *ETHERNET-MODULE* is selected to be added as shown in the figure below.

NOTE: See the next section for importing the configuration (L5X).

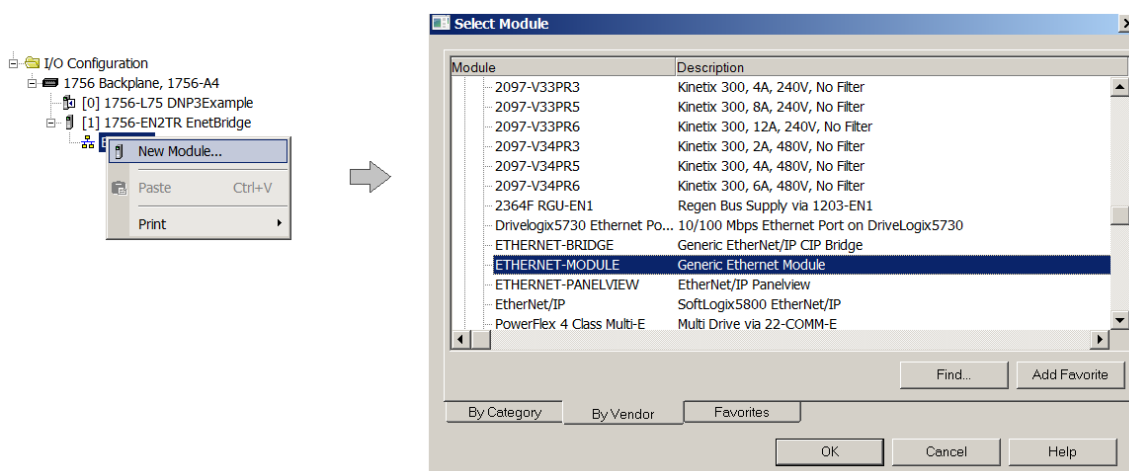

Figure 3.61 - Add a Generic Ethernet Module in RSLogix 5000

You must enter the IP address of the PLX51-DNPS module that will be used. The assembly instance and size must also be added for the input, output, and configuration in the connection parameters section. Below are the required connection parameters.

Connection Parameter	Assembly Instance	Size
Input	165	68 (32-bit)
Output	101	1 (32-bit)
Configuration	102	0 (8-bit)

Table 3.12 - RSLogix class 1 connection parameters for the PLX51-DNPS module

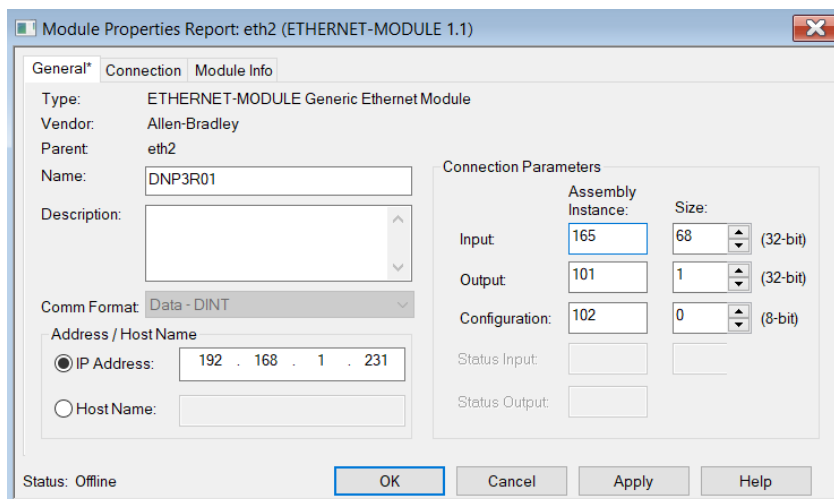

Figure 3.62 - RSLogix General module properties in RSLogix 5000

IMPORTANT: You will need to enter the exact connection parameters before the module will establish a class 1 connection with the Logix controller.

Next you need to add the connection requested packet interval (RPI). This is the rate at which the input and output assemblies are exchanged. The recommended value is 500ms. Refer to the technical specification section in this document for further details on the limits of the RPI.

IMPORTANT: Although the module is capable of running with an RPI of 10ms, it is recommended to set the RPI to 500ms, to avoid unnecessary loading of the module processor.

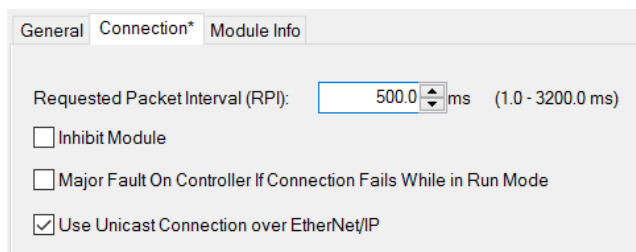

Figure 3.63 - Connection module properties in RSLogix 5000

Once the module has been added to the RSLogix 5000 IO tree, you must assign the User Defined Types (UDTs) to the input and output assemblies. You can import the required UDTs by right-clicking on *User-Defined* sub-folder in the *Data Types* folder of the IO tree and selecting *Import Data Type*. The assemblies are then assigned to the UDTs with a ladder copy instruction (COP) as shown in the figure below.

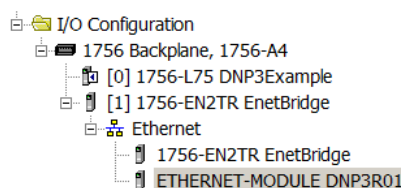

Figure 3.64 – RSLogix 5000 I/O module tree

Importing UDTs and Mapping Routines

To assist with the Logix integration, AOI and UDTs can be imported using the provided Objects Routine Import. This is provided for Logix V19.

The user can also use the example Logix code (ACD file) which is a stand-alone Logix example project for the PLX51-DNPS module. Both the routine import and stand-alone Logix files are available to download from the ProSoft website (www.prosoft-technology.com).

Below are the steps to import the AOIs and UDTs into a Logix project.

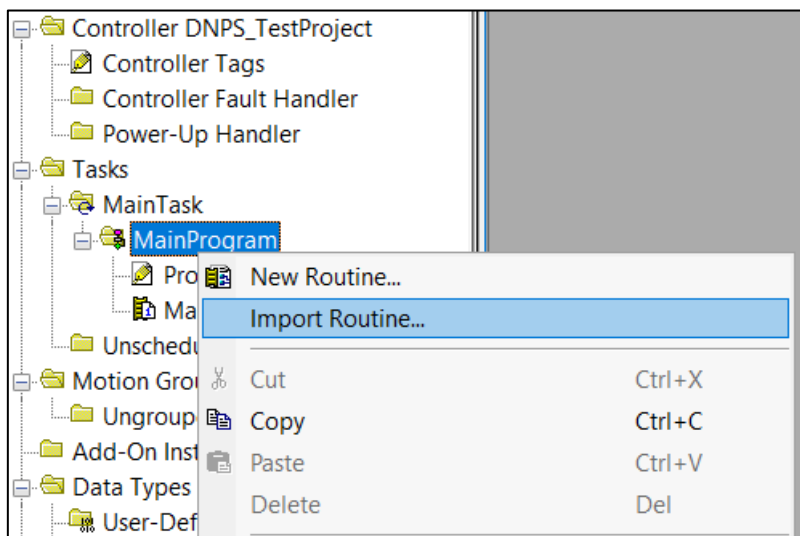

Figure 3.65 – RSLogix 5000 Importing PLX51-DNPS specific routine, UDTs, and AOIs

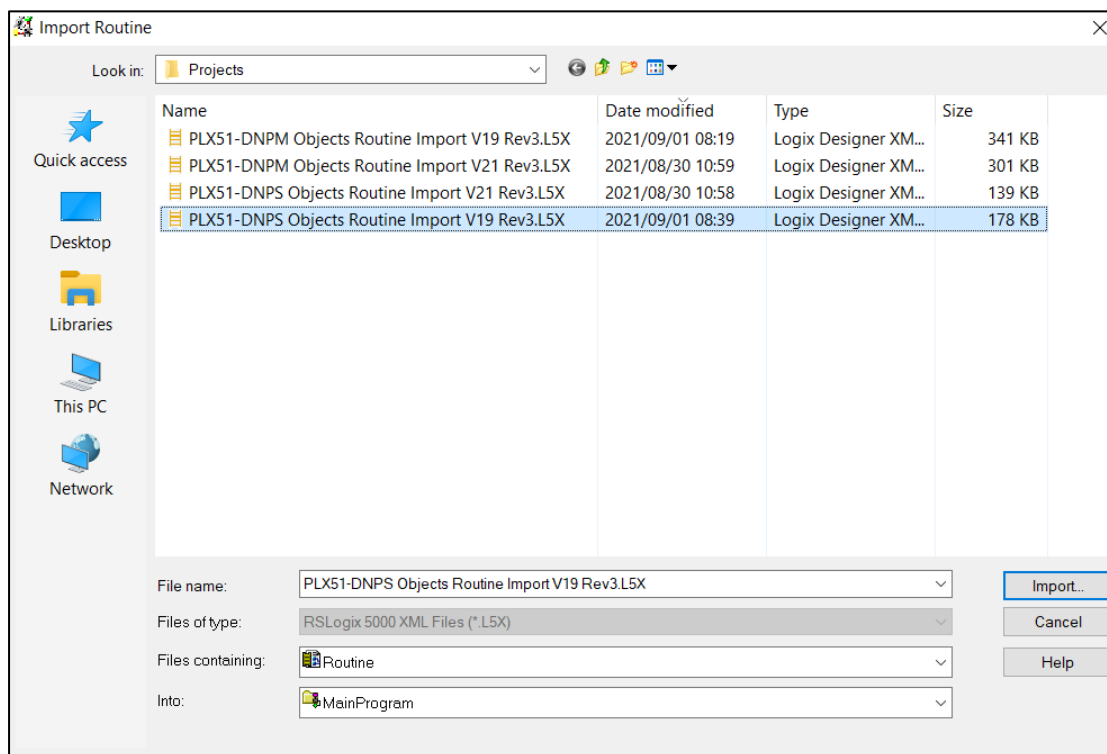

Figure 3.66 - Selecting partial import file

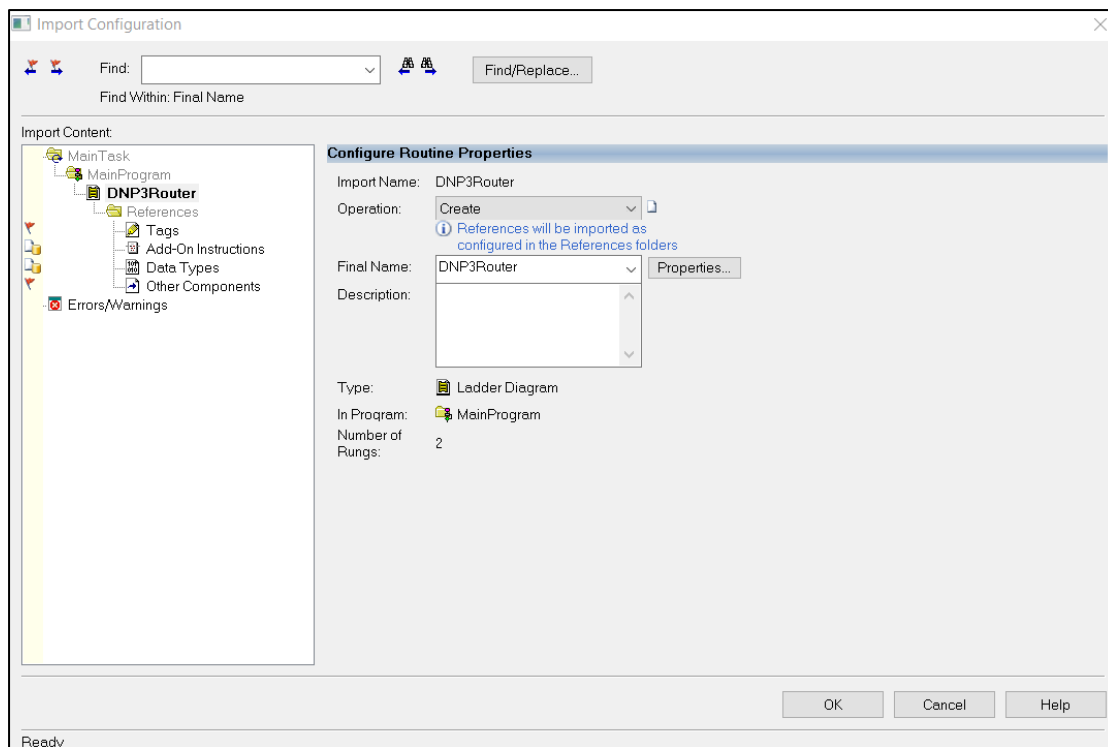

Figure 3.67 – Creating the UDTs, AOIs, and Routines

The import will create the following:

- The required UDTs (user-defined data types) and AOIs (Add-On Instructions)
- Two controller tags representing the Input and Output assemblies.
- A routine mapping the PLX51-DNPS module to the aforementioned tags.
- An example Unscheduled Message instruction with the associated tags

You may need to change the routine to map to the correct PLX51-DNPS module instance name, and make sure that the mapping routine is called by the Program's Main Routine.

NOTE: Once the UDTs have been imported, the user will need to add the necessary Controller Tags (using the required UDTs) to exchange DNP3 data with the DNPM module.

Refer to the [“Additional information”](#) section for an example RSLogix 5000 project as well as the required UDTs.

4 microSD Card

The PLX51-DNPS supports a microSD Card (see below) which can be used for disaster recovery. The microSD Card can be pre-loaded with the required firmware and/or application configuration.

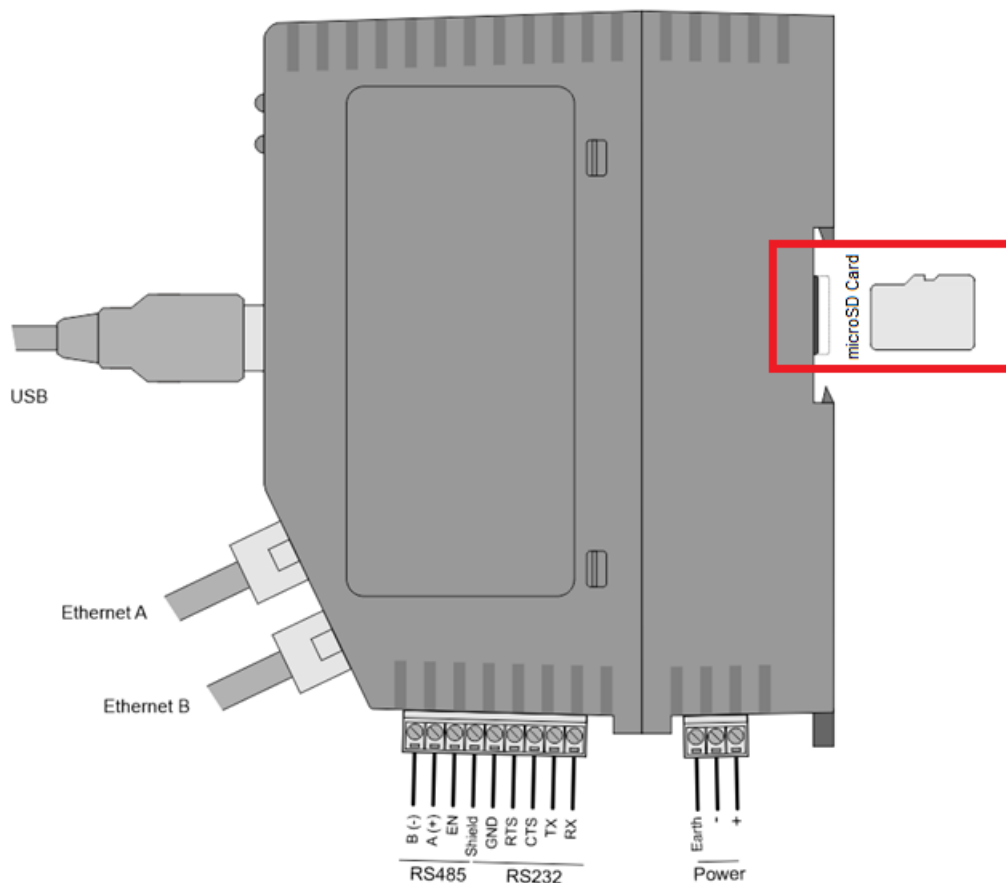

Figure 4.1 – Module side view – microSD Card Slot

IMPORTANT: You will need to ensure that the microSD Card has been formatted for FAT32.

IMPORTANT: All needed files must be copied into the root directory of the microSD Card. The module will not use files which are located in folders.

4.1 Firmware

You can copy the required firmware (Download at: www.prosoft-technology.com) onto the root directory of the microSD Card.

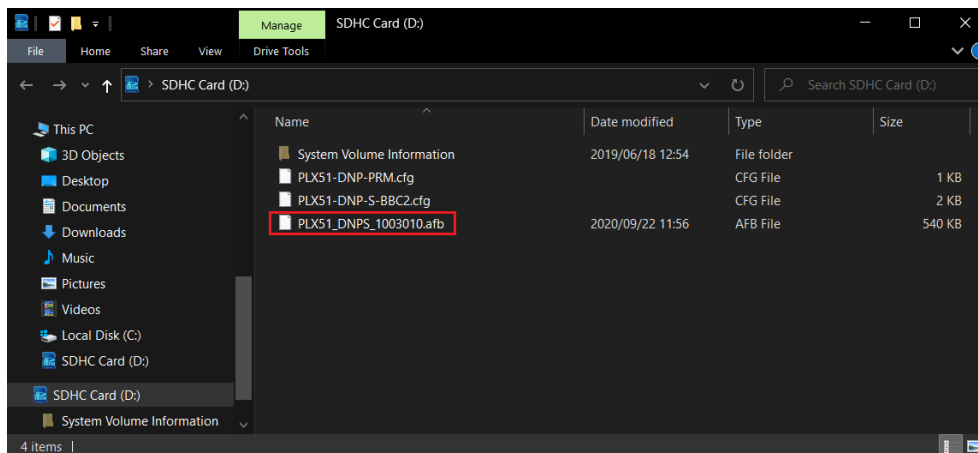

Figure 4.2 – microSD Card – firmware file

IMPORTANT: The filename of the firmware file must not be changed.

IMPORTANT: If more than one firmware file, with different firmware revisions, of the same product is on the microSD Card, it can cause the module to constantly firmware upgrade the module.

If a faulty module is replaced, you can insert the microSD Card with the firmware file on into the new module. While the module is booting, it can detect if the firmware on the new module is different from that on the microSD Card. If so, the firmware will either be upgraded or downgraded to the firmware revision on the microSD Card.

4.2 Configuration

If a faulty module is replaced, you can insert the microSD Card with the configuration file on into the new module. The new module will determine if the configuration on the microSD Card is different than the currently loaded configuration (even when there is no configuration on the module). If different, the configuration on the microSD Card will be downloaded into the module’s NV memory before the module starts executing.

You can add the PLX50CU configuration file to the microSD Card root directory in one of two ways: Manual copy or a PLX50CU upload.

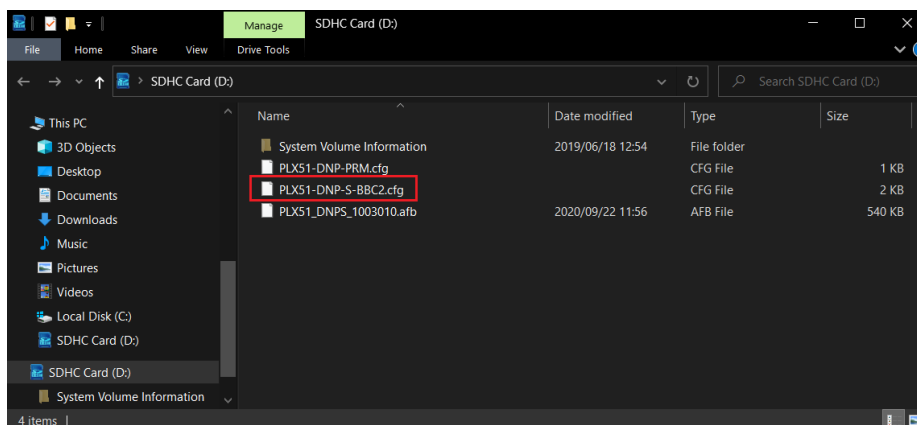

Figure 4.3 – microSD Card – configuration file

4.2.1 Manual Copy

Once you have created the configuration in the PLX50CU, the configuration can be exported to a file to be used on the microSD Card. You can copy this file into the root directory of the microSD Card.

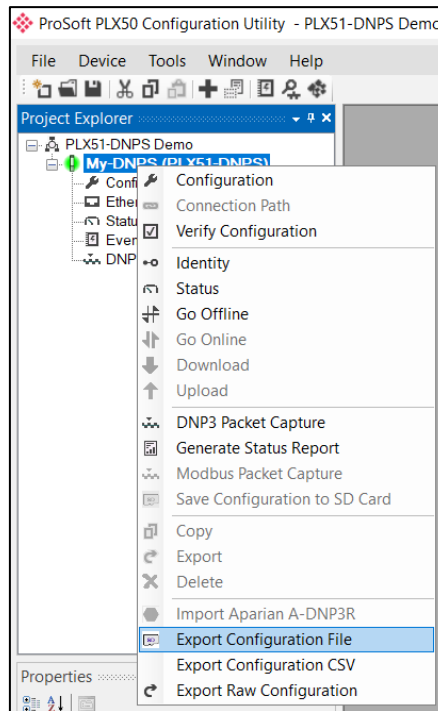

Figure 4.4 – Configuration export for microSD card

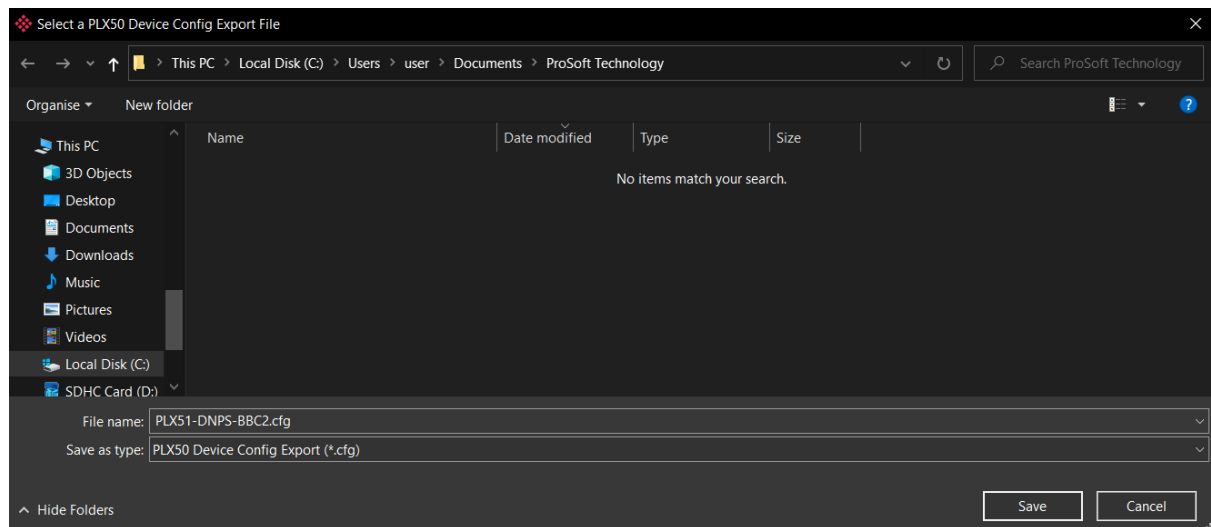

Figure 4.5 – Configuration export for microSD card

IMPORTANT: The filename of the configuration file must not be changed.

IMPORTANT: If more than one configuration file, with different configuration signatures, of the same product is on the microSD Card, then only the last configuration will be used.

4.2.2 PLX50CU Upload

When the microSD Card has been inserted into the module and you are online with the module in PLX50CU, you have the option to directly upload the configuration to the microSD Card using the *Save Configuration to SD Card* option. This will copy the configuration that has been downloaded to the module directly to the microSD Card without the need to remove it from the module and inserted into a PC.

IMPORTANT: All other configuration files in the microSD Card root directory will be deleted when the upload is complete.

NOTE: If the PLX51-DNPS module is using DNP3 Secure Authentication, then the Update Key will be encrypted and saved on the microSD Card. This will allow a replacement PLX51-DNPS to communicate using DNP3 Secure Authentication.

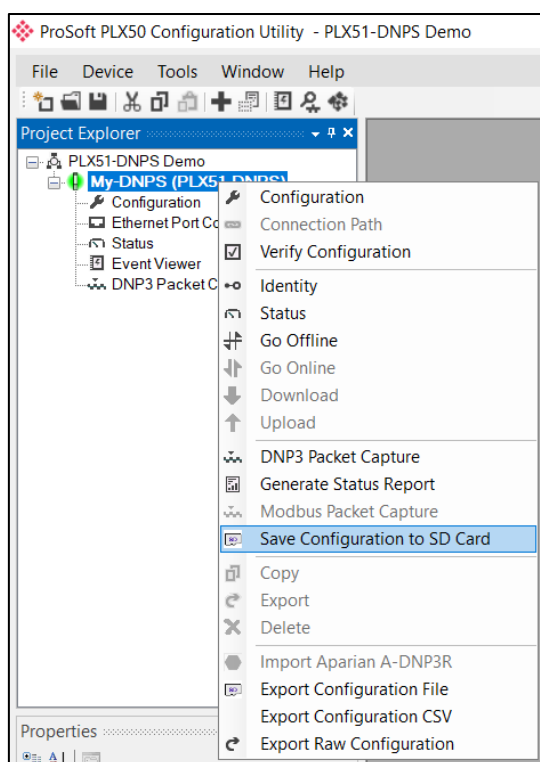

Figure 4.6 – Save configuration to microSD card

5 Logix Operation

5.1 Message Routing

After configuring the PLX51-DNPS, the DNP3 message initiator will send a read/write to a certain DNP3 group and variation which will then be routed to a Logix tag. The messages sent by the initiator must be completed with the correct data for successful operation. There are various indicators to determine if the mapping is routing the DNP3 messages correctly. Refer to the [“Diagnostics”](#) section for a more detailed explanation of the various indicators that can be used to diagnose the module.

5.2 RSLogix 5000 assemblies

When the module operates in a Logix “owned” mode the Logix controller will establish a class 1 cyclic communication connection with the PLX51-DNPS. An input and output assembly is exchanged at a fix interval. The UDTs provided will convert the input and output arrays into tag based assemblies. Refer to the [“Additional Information”](#) section for the input and output UDTs.

▶ PLX51DNPSInput.Instance	'DNPS-EventsCLX'	{...}		STRING
▶ PLX51DNPSInput.Status		{...}	{...}	PLX51DNPStatus
▶ PLX51DNPSInput.MasterMappedStatus		{...}	{...}	Decimal
▶ PLX51DNPSInput.TransactionRate	0			Decimal
▶ PLX51DNPSInput.Temperature	39.44635			Float
▶ PLX51DNPSInput.DNP3RxPacketCount	107			Decimal
▶ PLX51DNPSInput.DNP3TxPacketCount	0			Decimal
▶ PLX51DNPSInput.DNP3ChecksumErrors	0			Decimal
▶ PLX51DNPSInput.DNP3MsgTimeout	0			Decimal
▶ PLX51DNPSInput.AuthenticationFailures	0			Decimal
▶ PLX51DNPSInput.SessionKeyChanges	0			Decimal
▶ PLX51DNPSInput.TagReads	107			Decimal
▶ PLX51DNPSInput.TagWrites	0			Decimal
▶ PLX51DNPSInput.TagConnectionFailures	0			Decimal
▶ PLX51DNPSInput.TagErrors	0			Decimal
▶ PLX51DNPSInput.MasterEventBufferIndex	0			Decimal

Figure 5.1 - Input assembly structure

5.2.1 Input Assembly

The following parameters are used in the input assembly of the module.

Parameter (PLX51DNPSInput.)	Datatype	Description
Instance	STRING	This parameter is the instance name of the module that was configured under the general DNP3 configuration in PLX50 Configuration Utility.
Status.OutstationTagMode	BOOL	Set if the module is operating in Outstation Tag mode.
Status.MasterTagMode	BOOL	Set if the module is operating in Master Tag mode.
Status.UnscheduledMode	BOOL	Set if the module is operating in Unscheduled mode.
Status.ConfigurationValid	BOOL	Set if a valid configuration is executing in the module.

Status.RoutingInhibited	BOOL	Set when the module's routing function has been inhibited. Routing can be inhibited by setting a bit in the output assembly of the module.
Status.DNP3EventLogOk	BOOL	The DNP3 event log was correctly loaded on startup.
Status.DNP3EventLogOverflow	BOOL	At least one of the DNP3 Group Classes have reached the maximum allowed DNP3 events of 50,000.
MasterMappedStatus.MasterTagStatus0...29	BOOL[30]	Each bit represents the status of the last scheduled transaction for that specific map item. A true value indicates success.
TransactionRate	DINT	The transaction rate is the number of DNP3 messages per second that the module is currently routing.
DeviceTemperature	REAL	The internal temperature of the module.
DNP3RxPacketCount	DINT	The total number of DNP3 packets received by the module.
DNP3TxPacketCount	DINT	The number of DNP3 packets sent by the module.
DNP3ChecksumErrors	DINT	The number of corrupted DNP3 packets received by the module.
DNP3MsgTimeout	DINT	The number of timed-out DNP3 packets sent by the module. Thus no reply was received.
Authentication Failures	DINT	The amount of authentication failures detected by the module. This could indicate the presence of a security threat in the form of an attacker.
Session Key Changes	DINT	The amount of session key changes done.
TagReads	DINT	The total number of tag reads executed by the module when operating in Tag Map mode.
TagWrites	DINT	The total number of tag writes executed by the module when operating in Tag Map mode.
TagConnectionFailures	DINT	The number of failed class 3 connection attempts when operating in Tag Map mode. Tag reading and writing requires the module to first establish a class 3 connection with the Logix Controller.
TagErrors	DINT	The number of failed tag access (read/write) requests when operating in tag Map mode. These may include privileged violations, non-existing tags, etc.
MasterEventBufferIndex	DINT	The Master Event Tag UDT array index number where the next event received from the master will be unloaded.

Table 5.1 - RSLogix 5000 input assembly parameters

5.2.2 Output Assembly

The following parameters are used in the output assembly of the module.

Parameter	Datatype	Description
RoutingInhibit	BOOL	This bit inhibits the module routing capabilities. When set, no DNP3 messages will be routed. This may be required in applications running a redundant DNP3 network where one of the PLX51-DNPS's is to run in a hot-standby mode.

Table 5.2 - RSLogix 5000 output assembly parameters

6 DNP3 Operation

6.1 General

DNP3 supports various formats for each group of data points. The different formats can include additional data for the requested variable (e.g. Status, Time, etc.). For this reason, the Logix or Modbus controller needs to map the data for these formats to User-Defined Data Types (UDTs) or Modbus Registers.

6.1.1 EtherNet/IP

A range of UDTs have been provided to you, allowing for easy and seamless integration with the Logix or Micro800 controller. Below are examples of how these UDTs are to be used.

When DNP3 group 30 (Analog Inputs) has been selected, there is a range of variations that can be used. They provide different format and additional information for you. If variation 5 was selected, the data returned will be a Single Floating Point number with a Flag (or Status bits) as shown below:

Logix Controller Mapping (max. of 3 items.)

Target Name	Controller Path	Browse
NorthCPU	192.168.1.104,1,0	...
SouthCPU	192.168.1.6,1,0	...

Tag Mapping Items (max. of 1000 items.)

Group	Variation	Index Start	Index Count	Target Name	Target Tag	Browse	Enable Events	Event Variation	DB
G030 AnalogInputs	V05 Single Float + Flag	0	5	NorthCPU	VoltageInputs[0]	...	<input type="checkbox"/>		

Figure 6.1 – DNP3 Group 30 selected with Variation 5

Logix Controller

You must select the correct UDT provided in the example RSLogix 5000 project (see the [“Additional Information”](#) section for further details). In this case, the example project has a UDT called *PSDNP3AnalogInputRealFlag*. This will correctly map the additional information from the DNP3 Object as shown below:

Name	Data Type	Style	Description	External Access
Online	BOOL	Decimal		Read/Write
Restart	BOOL	Decimal		Read/Write
CommLost	BOOL	Decimal		Read/Write
RemoteForced	BOOL	Decimal		Read/Write
LocalForced	BOOL	Decimal		Read/Write
OverRange	BOOL	Decimal		Read/Write
ReferenceError	BOOL	Decimal		Read/Write
Value	REAL	Float		Read/Write

Figure 6.2 – Supported UDT for DNP3 Group 30 with Variation 5

A new tag or array must be created to match the DNP3 Group and Variation.

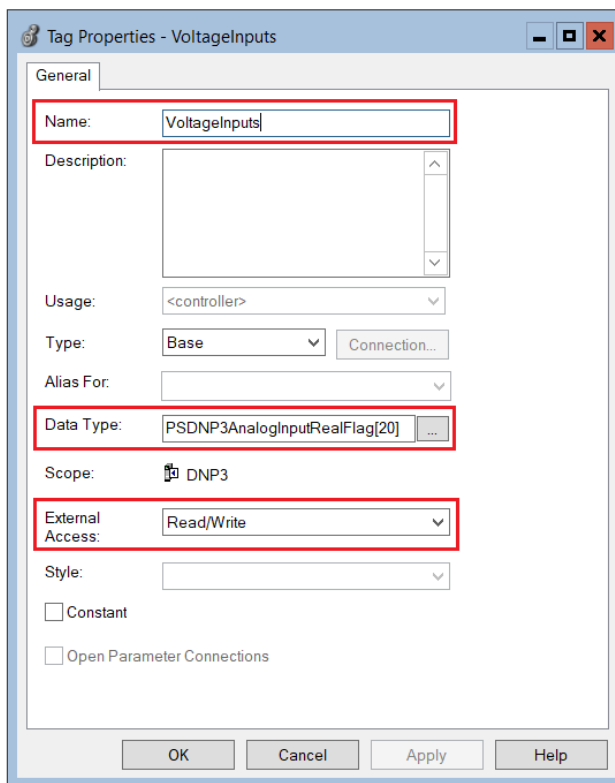

Figure 6.3 – New tag with supported UDT for DNP3 Group 30 with Variation 5

In PLX50 Configuration Utility, the **Target Tag** selected must be the Tag or Array with Data Type **PSDNP3AnalogRealFlag**.

The same procedure can be followed for numerous DNP3 Group and Variation combinations.

IMPORTANT: If you do not use the correct UDT, the PLX51-DNPS will either abandon the routing procedure once it detects the dissimilar data types (the Logix Data Type Mismatch statistic will increase), or incorrect data will be received by the Logix Controller.

Micro800 Controller

You must select the correct DataType provided in the example Micro800 project (see the [“Additional Information”](#) section for further details). In this case, the example project has a datatype called *PSDNP3AnalogInputRealFlag*.

MyAnalogInputV500	PSDNP3AnalogInputRealFlag	...
MyAnalogInputV500.Online	BOOL	FALSE
MyAnalogInputV500.Restart	BOOL	FALSE
MyAnalogInputV500.CommLost	BOOL	FALSE
MyAnalogInputV500.RemoteForced	BOOL	FALSE
MyAnalogInputV500.LocalForced	BOOL	FALSE
MyAnalogInputV500.OverRange	BOOL	FALSE
MyAnalogInputV500.ReferenceError	BOOL	FALSE
MyAnalogInputV500.EventTrigger	BOOL	FALSE
MyAnalogInputV500.Value	REAL	0.0

Figure 6.4 – Supported DataTypes for DNP3 Group 30 with Variation 5

This will correctly map the additional information from the DNP3 Object as shown below:

Tag Mapping Items (max. of 1000 items.)

	En	Group	Variation	Index Start	Index Count	Target Name	Target Tag	Browse	Enable Events
▶	<input checked="" type="checkbox"/>	G001 BinaryInputs	V02 + Flags	0	2	Micro800	DNP3_BinaryInputBlockV2A[0]	...	<input type="checkbox"/>
	<input checked="" type="checkbox"/>	G010 BinaryOutputs	V02 Output Status + Fl...	0	2	Micro800	DNP3_BinaryOutputBlockV2A...	...	<input type="checkbox"/>
	<input checked="" type="checkbox"/>	G012 BinaryOutputCo...	V01 CROB	0	1	Micro800	DNP3_CROBBlockV100[0]	...	<input type="checkbox"/>
	<input checked="" type="checkbox"/>	G012 BinaryOutputCo...	V01 CROB	1	1	Micro800	DNP3_CROBBlockV101[0]	...	<input type="checkbox"/>
	<input checked="" type="checkbox"/>	G020 Counters	V01 32-bit + Flag	0	2	Micro800	DNP3_CounterBlockV1A[0]	...	<input type="checkbox"/>
	<input checked="" type="checkbox"/>	G030 AnalogInputs	V05 Single Float + Flag	0	2	Micro800	DNP3_AnalogInputBlockV5A[0]	...	<input type="checkbox"/>
	<input checked="" type="checkbox"/>	G040 AnalogOutputSt...	V03 Single Float + Flag	0	2	Micro800	DNP3_AnalogOutputStatusBl...	...	<input type="checkbox"/>
	<input checked="" type="checkbox"/>	G041 AnalogOutputs	V03 Single Float	0	1	Micro800	DNP3_AnalogOutputCmdBloc...	...	<input type="checkbox"/>
	<input checked="" type="checkbox"/>	G041 AnalogOutputs	V03 Single Float	1	1	Micro800	DNP3_AnalogOutputCmdBloc...	...	<input type="checkbox"/>
*	<input type="checkbox"/>								<input type="checkbox"/>

Figure 6.5 – DNP3 Group 30 selected with Variation 5

A new tag or array must be created with datatype SINT array. As per the example code, the data will then be mapped to the correct DNP DataType in the Micro800 controller.

▶	DNP3_AnalogInputBlockV5A	SINT	...	[0..63]	...
	DNP3_AnalogInputBlockV5A[0]	SINT	0		
	DNP3_AnalogInputBlockV5A[1]	SINT	0		
	DNP3_AnalogInputBlockV5A[2]	SINT	0		
	DNP3_AnalogInputBlockV5A[3]	SINT	0		

Figure 6.6 – New tag which will be mapped to supported UDT for DNP3 Group 30 with Variation 5

In PLX50 Configuration Utility, the **Target Tag** selected must be the Tag or Array with Data Type **PSDNP3AnalogRealFlag**.

The same procedure can be followed for numerous DNP3 Group and Variation combinations.

IMPORTANT: If you do not use the correct UDT, the PLX51-DNPS will either abandon the routing procedure once it detects the dissimilar data types (the Logix Data Type Mismatch statistic will increase), or incorrect data will be received by the Logix Controller.

6.1.2 Modbus

When selecting Modbus, the DNP data will be mapped to the configured Modbus Register (HR, IR, IS, CS) based on the below formatting. The PLX51-DNPS supports the full Modbus range for each Modbus register.

The DNP3 data will be formatted as shown below for Modbus Registers.

DNP3 Group	DNP3 Variation	DNP3 Description	Modbus Format
1	1	Packed	No Padding
1	2	+ Flags	1 Byte Data&Flag + 1 Byte Pad NOTE: Byte Padding will only be applied for IR and HR register types.
3	1	Packed	No Padding
3	2	+ Flags	1 Byte Data&Flag + 1 Byte Pad NOTE: Byte Padding will only be applied for IR and HR register types.
10	1	Packed	No Padding
10	2	Status + Flags	1 Byte Data&Flag + 1 Byte Pad NOTE: Byte Padding will only be applied for IR and HR register types.
12	1	CROB	2 Bytes Receive Flag + 11 Bytes Data + 1 Byte Pad NOTE: The receive flag Bit 0 is used to indicate to the Controller that a new operate command has been received.
20	1	32bit + Flag	1 Byte Flag + 1 Byte Pad + 4 Bytes Data + 2 Byte Frozen Flag + 6 Byte Time
20	2	16bit + Flag	1 Byte Flag + 1 Byte Pad + 2 Bytes Data + 2 Byte Frozen Flag + 6 Byte Time
20	5	32bit + No Flag	4 Bytes Data + 2 Byte Frozen Flag + 6 Byte Time
20	6	16bit + No Flag	2 Bytes Data + 2 Byte Frozen Flag + 6 Byte Time
21	1	32bit + Flag	1 Byte Flag + 1 Byte Pad + 4 Bytes Data
21	2	16bit + Flag	1 Byte Flag + 1 Byte Pad + 2 Bytes Data
21	5	32bit + Flag + Time	1 Byte Flag + 1 Byte Pad + 4 Bytes Data + 6 Bytes Time
21	6	16bit + Flag + Time	1 Byte Flag + 1 Byte Pad + 2 Bytes Data + 6 Bytes Time
21	9	32bit + No Flag	No Padding
21	10	16bit + No Flag	No Padding
30	1	32bit + Flag	1 Byte Flag + 1 Byte Pad + 4 Bytes Data
30	2	16bit + Flag	1 Byte Flag + 1 Byte Pad + 2 Bytes Data
30	3	32bit + No Flag	No Padding
30	4	16bit + No Flag	No Padding
30	5	Float + Flag	1 Byte Flag + 1 Byte Pad + 4 Bytes Data
40	1	32bit + Flag	1 Byte Flag + 1 Byte Pad + 4 Bytes Data
40	2	16bit + Flag	1 Byte Flag + 1 Byte Pad + 2 Bytes Data
40	3	Float + Flag	1 Byte Flag + 1 Byte Pad + 4 Bytes Data
41	1	32bit	2 Bytes Receive Flag + 4 Bytes Data + 1 Byte Control + 1 Byte Pad NOTE: The receive flag Bit 0 is used to indicate to the Controller that a new operate command has been received.
41	2	16bit	2 Bytes Receive Flag + 2 Bytes Data + 1 Byte Control + 1 Byte Pad NOTE: The receive flag Bit 0 is used to indicate to the Controller that a new operate command has been received.

41	3	Float	2 Bytes Receive Flag + 4 Bytes Data + 1 Byte Control + 1 Byte Pad NOTE: The receive flag Bit 0 is used to indicate to the Controller that a new operate command has been received.
102	1	8bit	1 Byte Data + 1 Byte Pad NOTE: Byte Padding will only be applied for IR and HR register types.
110	1	8bit	There is no padding for the octet strings. The string value will be read or written to the Modbus Registers on a per byte basis. Once the string ends a zero will be written to the last byte. This zero must be used as the delimiter for the string.

Table 6.1 – Modbus format for DNP3 group/variation Data

IMPORTANT: When communications are lost to the Modbus interface, all the DNP3 object flags will be forced to shown NO_COMMS.
 When operating as a Modbus Slave, the Modbus communications has failed when there has been no communications within the *Modbus Slave Timeout*.
 When operating as a Modbus Master, the Modbus communications has failed when any of the *Modbus Master Mapping* items has failed.

6.2 Analog/Binary Output Commands

The PLX51-DNPS with the *Operating Interface* set to EtherNet/IP or Modbus will respond to operate commands from the DNP3 Master.

The *Select/Operate*, *Direct-Operate*, and *Direct-Operate with no response* DNP3 application functions (collectively referred to as operate commands) are command-based functions. Unlike a read function, these functions only execute when the DNP3 Master triggers a change (e.g. open a relay or change an analog output). These functions are typically used for Control Relay Output Blocks (CROB) and Analog Output Blocks (AOB). The three functions are described below:

Function	Description
Select/Operate	The select/operate function is a two-step operate where the Master first “Arms” the outputs with the select function before enabling the “Armed” output with the operate function.
Direct-Operate	The Direct-Operate function has a similar outcome to the Select/Operate function but is a one-step function. Thus, the outputs are “Armed” and executed in the same function.
Direct-Operate with no response	The Direct-Operate with no response function is similar to the Direct-Operate but does not require an acknowledgement that the operation has been executed.

Table 6.2 – Select/Operate, Direct-operate, and Direct-Operate no reponse functions

IMPORTANT: The PLX51-DNPS can only receive one Operate request per Group Item at a time.

6.2.1 EtherNet/IP

The PLX51-DNPS uses a **RequestPending** bit in the Logix UDT tags (refer to the example code for provided UDTs) to inform the controller that a operate request has been received.

An example of a UDT with the *RequestPending* bit is shown below:

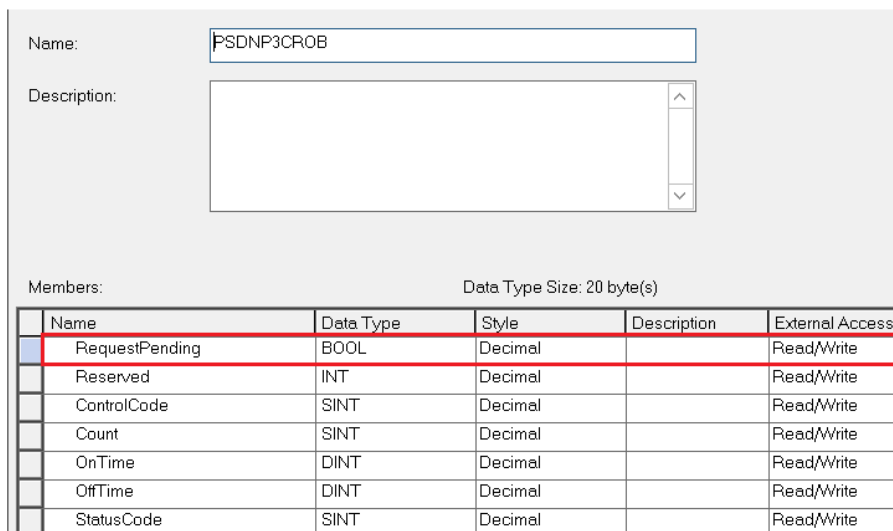

Figure 6.7 – UDT for operate commands

Receiving Output Commands

The PLX51-DNPS requires two items to be mapped for each Binary or Analog Output Command. The first being the Command (Group 12 or Group 41) and the second the Output Status (Group 10 or Group 40).

The *RequestPending* bit in the mapped Logix Tag for the control command will be set, indicating that a new operate command was received. The Logix Controller should copy the values Command UDT to the respective Status UDT (Binary: Group 12 to 10, Analog: Group 41 to 40). Then clear the *RequestPending* bit which signals the master that the operation is complete. The Outstation Example contains AOIs that perform these tasks. Including code to pulse binary outputs. Commands with *StatusCode* other than zero should be ignored.

Group	Variation	Index Start	Index Count	Target Name	Target Tag
G012 BinaryOutputCommands	V01 CROB	0	5	NorthCPU	DNP3G12V01[0]
G010 BinaryOutputs	V02 Output Status + Fla...	0	5	NorthCPU	DNP3G10V02[0]
G041 AnalogOutputs	V02 16-bit	0	5	NorthCPU	DNP3G41V02[0]
G040 AnalogOutputStatus	V02 16-bit + Flag	0	5	NorthCPU	DNP3G40V02[0]

Figure 6.8 – Outstation mapping for output commands

Care should be taken to ensure the matching Analog Variations are used with Group 40 and 41.

To ensure the command was executed, the master can either read the Output Status (Groups 10, 40) or configure an event on the Status and Command groups.

Control Relay Output Block (CROB) Parameters

An example of a CROB command (Group 12 Variation 1) tag is shown below.

Name	Value	Style	Data Type
DNP3G12V01[0]	{ . . . }		PSDNP3CROB
-DNP3G12V01[0].RequestPending	0	Decimal	BOOL
+DNP3G12V01[0].Reserved	0	Decimal	INT
+DNP3G12V01[0].ControlCode	4	Decimal	SINT
+DNP3G12V01[0].Count	5	Decimal	SINT
+DNP3G12V01[0].OnTime	200	Decimal	DINT
+DNP3G12V01[0].OffTime	380	Decimal	DINT
+DNP3G12V01[0].StatusCode	0	Decimal	SINT

Figure 6.9 - DNP3 CROB Group Variation 1

Below is a table of the valid CROB control codes.

Control Code	Description
0	Null
1	Pulse On
2	Pulse Off
3	Latch On
4	Latch Off

Table 6.3 - DNP3 CROB control codes

The Count, OnTime, and OffTime elements are only used when there is a pulse command (1 or 2). The count is the amount of pulses that must be executed whilst the OnTime and OffTime is the relevant duty cycle. Refer to the Logix example code for an implemented example.

See the *DNP3 Control Relay Output Block - CROB* section in the appendix for more information.

6.2.2 Modbus

The PLX51-DNPS uses Bit-0 of the 2 byte receive flag to inform the controller that a operate request has been received.

The DNP3 data will be formatted as shown below for Modbus Registers.

DNP3 Group	DNP3 Variation	DNP3 Description	Modbus Format
12	1	CROB	2 Bytes Receive Flag + 11 Bytes Data + 1 Byte Pad NOTE: The receive flag Bit 0 is used to indicate to the Controller that a new operate command has been received.
41	1	32bit	2 Bytes Receive Flag + 4 Bytes Data + 1 Byte Control + 1 Byte Pad NOTE: The receive flag Bit 0 is used to indicate to the Controller that a new operate command has been received.
41	2	16bit	2 Bytes Receive Flag + 2 Bytes Data + 1 Byte Control + 1 Byte Pad NOTE: The receive flag Bit 0 is used to indicate to the Controller that a new operate command has been received.
41	3	Float	2 Bytes Receive Flag + 4 Bytes Data + 1 Byte Control + 1 Byte Pad NOTE: The receive flag Bit 0 is used to indicate to the Controller that a new operate command has been received.

Table 6.4 – Modbus format for DNP3 Operate group/variation data

Receiving Output Commands

The PLX51-DNPS requires two items to be mapped for each Binary or Analog Output Command. The first being the Command (Group 12 or Group 41) and the second the Output Status (Group 10 or Group 40).

Bit-0 of the 2-byte receive flag for the control command will be set, indicating that a new operate command was received. The Modbus Controller should copy the relevant to the respective Status Modbus Registers (Binary: Group 12 to 10, Analog: Group 41 to 40). Then clear Bit-0 which signals the master that the operation is complete. Commands with *StatusCode* other than zero should be ignored.

En	Group	Variation	Index Start	Index Count	Register Type	Modbus Offset	Enable Events
<input checked="" type="checkbox"/>	G012 BinaryOutputCommands	V01 CROB	0	5	HR	100	<input type="checkbox"/>
<input checked="" type="checkbox"/>	G010 BinaryOutputs	V02 Output Status + Flags	0	5	HR	200	<input type="checkbox"/>
<input checked="" type="checkbox"/>	G041 AnalogOutputs	V02 16-bit	0	5	HR	300	<input type="checkbox"/>
<input checked="" type="checkbox"/>	G040 AnalogOutputStatus	V02 16-bit + Flag	0	5	HR	400	<input type="checkbox"/>
** <input type="checkbox"/>							<input type="checkbox"/>

Figure 6.10 – Outstation mapping for output commands

Care should be taken to ensure the matching Analog Variations are used with Group 40 and 41.

To ensure the command was executed, the master can either read the Output Status (Groups 10, 40) or configure an event on the Status and Command groups.

Control Relay Output Block (CROB) Parameters

An example of a CROB command (Group 12 Variation 1) Modbus Register is shown below.

Modbus Register	Parameter
x	Receive Flag Bit 0 - When set a new operate has been received
x + 1	Low Byte - Control Code High Byte - Count
x + 2	On-Time (lower 16bits)
x + 3	On-Time (upper 16bits)
x + 4	Off-Time (lower 16bits)
x + 5	Off-Time (upper 16bits)
x + 6	Low Byte - Status Code High Byte - Reserved

Table 6.5 - DNP3 CROB Group Variation 1

Below is a table of the valid CROB control codes.

Control Code	Description
0	Null
1	Pulse On
2	Pulse Off
3	Latch On
4	Latch Off

Table 6.6 - DNP3 CROB control codes

The Count, OnTime, and OffTime elements are only used when there is a pulse command (1 or 2). The count is the amount of pulses that must be executed whilst the OnTime and OffTime is the relevant duty cycle.

See the *DNP3 Control Relay Output Block - CROB* section in the appendix for more information.

NOTE: The module will not execute the Pulse On or Pulse Off. This will need to be done by the operating interface controller. The module will provide the required information (e.g. Pulse On for 2 seconds, 5 times) for the Modbus controller to execute the required action.

6.3 Counter Freeze Commands

The PLX51-DNPS with the *Operating Interface* set to EtherNet/IP or Modbus will respond to Freeze commands from the DNP3 Master.

6.3.1 EtherNet/IP

If the DNP3 Master issues a Freeze command, the Logix controller will be notified and must execute the requested command. This is done by using a Freeze Counter Control UDT from the Logix controller.

IMPORTANT: The Control Tag must be named identical to that of the DNP3 Counter Tag used with the addition of “Ctrl” suffix. For example, if the DNP3 Counter tag being used is named **ShiftCounter**, the Freeze Control Tag must be named **ShiftCounterCtrl**. You must also ensure that the dimensions of the two tag arrays are the same.

The Counter control will use the **PSDNP3CounterCtrl** UDT as shown below:

Name	Value	Style	Data Type
ShiftCounter	{...}		PSDNP3Counter32WithFlag[10]
ShiftCounter[0]	{...}		PSDNP3Counter32WithFlag
ShiftCounter[0].Online	0	Decimal	BOOL
ShiftCounter[0].Restart	0	Decimal	BOOL
ShiftCounter[0].CommLost	0	Decimal	BOOL
ShiftCounter[0].RemoteForced	0	Decimal	BOOL
ShiftCounter[0].LocalForced	0	Decimal	BOOL
ShiftCounter[0].RollOver	0	Decimal	BOOL
ShiftCounter[0].Discontinuity	0	Decimal	BOOL
ShiftCounter[0].EventTrigger	0	Decimal	BOOL
ShiftCounter[0].Value	0	Decimal	DINT
ShiftCounterCtrl	{...}		PSDNP3CounterCtrl[10]
ShiftCounterCtrl[0]	{...}		PSDNP3CounterCtrl
ShiftCounterCtrl[0].FreezeCounter	0	Decimal	BOOL
ShiftCounterCtrl[0].ClearCounter	0	Decimal	BOOL
ShiftCounterCtrl[0].TimeOfOccurrence	0	Decimal	LINT

Figure 6.11 – Freeze command pair

Group	Variation	Index Start	Index Count	Target Name	Target Tag
G020 Counters	V01 32-bit + Flag	0	10	NorthCPU	ShiftCounter[0]

Figure 6.12 – Outstation Mapping - Counter

The Control Tag will either have the Freeze bit or Freeze and Clear bits set to indicate the counter values must be copied to the DNP3 Frozen Counter Group tags, and if the Counter must be cleared afterwards. Refer to the Logix Example code for an example of how this is done. The time of occurrence is the DNP3 time (Unix time in milliseconds) when the freeze command was received. This must be copied to the DNP3 Frozen Counter Group tag.

6.3.2 Modbus

If the DNP3 Master issues a Freeze command, the specific DNP3 Counter Modbus Register will be updated in the Frozen Flag section to indicate to the Modbus device if the counters must be frozen and/or cleared.

IMPORTANT: It is the Modbus device's (interfacing to the PLX51-DNPS module) responsibility to copy the Counter value to the specific Frozen Counter Modbus Registers, and clear the Frozen flag. The same applies for the clear flag indication where the Modbus device will need to clear the counter values.

The DNP3 Counter structure in Modbus is shown below:

DNP3 Group	DNP3 Variation	DNP3 Description	Modbus Format
20	1	32bit + Flag	1 Byte Flag + 1 Byte Pad + 4 Bytes Data + 2 Byte Frozen Flag + 6 Byte Time
20	2	16bit + Flag	1 Byte Flag + 1 Byte Pad + 2 Bytes Data + 2 Byte Frozen Flag + 6 Byte Time
20	5	32bit + No Flag	4 Bytes Data + 2 Byte Frozen Flag + 6 Byte Time
20	6	16bit + No Flag	2 Bytes Data + 2 Byte Frozen Flag + 6 Byte Time
21	1	32bit + Flag	1 Byte Flag + 1 Byte Pad + 4 Bytes Data
21	2	16bit + Flag	1 Byte Flag + 1 Byte Pad + 2 Bytes Data
21	5	32bit + Flag + Time	1 Byte Flag + 1 Byte Pad + 4 Bytes Data + 6 Bytes Time
21	6	16bit + Flag + Time	1 Byte Flag + 1 Byte Pad + 2 Bytes Data + 6 Bytes Time
21	9	32bit + No Flag	No Padding
21	10	16bit + No Flag	No Padding

Table 6.7 – DNP3 Counter Modbus format

The two-byte frozen flag has the following format:

Bit 0 – Freeze Counter

Bit 1 – Clear Counter

Below is an example of the Freeze Command process when using a Modbus Interface.

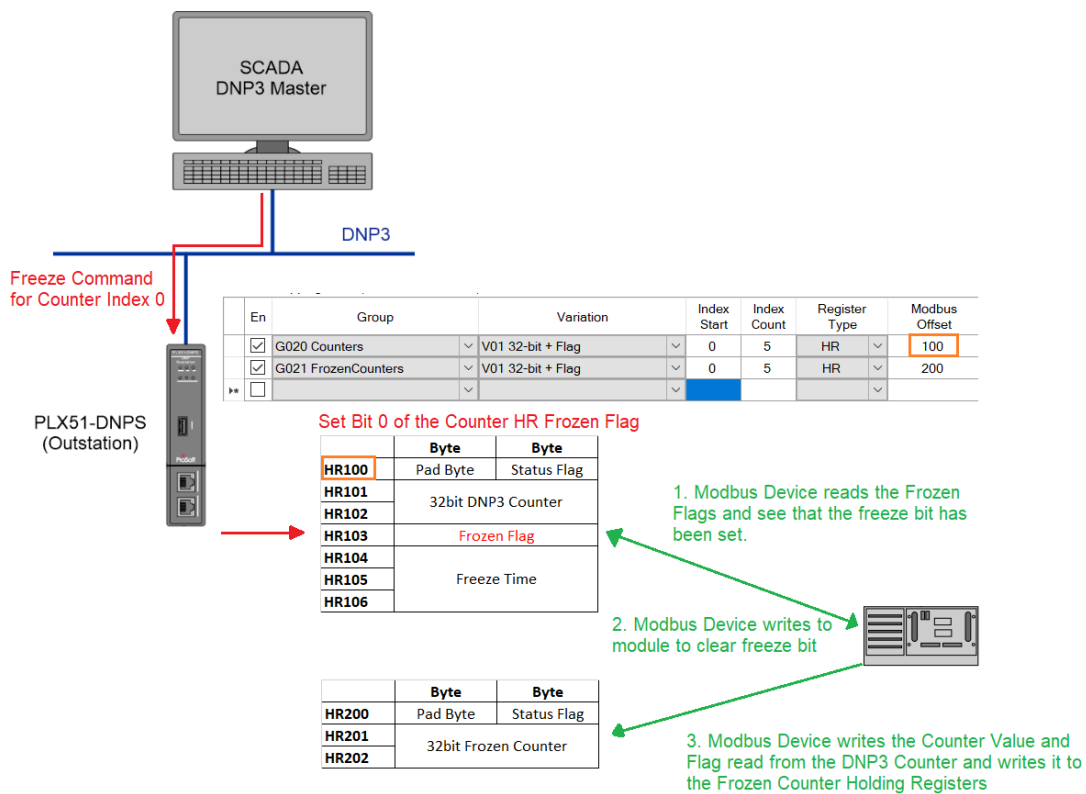

Figure 6.13 – Freeze Command with Modbus Interface

6.4 DNP3 Events and Unsolicited Responses

Events are generated in the Outstation and processed by the Master. Events can be grouped during the unloading process by either their assigned Class or Data Type Group (e.g. Group 32 – Analog) or on a per-data-point basis. Unloading can be initiated by the Master via a set interval poll or initiated by the Outstation via an Unsolicited Response message. The DNP3 Master controls each Outstation’s ability to send Unsolicited Messages.

Unsolicited Events can be used to reduce network traffic by reducing or turning off polled data exchanges. This method is referred to as Report-By-Exception.

6.4.1 Outstation Event Configuration

To enable unsolicited events, the following configuration is required:

Enabling Events

Enable Events for each mapped item in the Outstation Mapping enables the PLX51-DNPS to start reading each Logix item or Modbus register at an interval of 10ms. It determines if there has been either a change in the status flags, if the value has changed by more than the deadband, or if the Log Time has been reached.

Tag Mapping Items (max. of 1000 items.)

En	Group	Variation	Index Start	Index Count	Target Name	Target Tag	Browse	Enable Events	Evt Variation	DB	Log Time	Class	Forced Unsol.
<input checked="" type="checkbox"/>	G030 AnalogInputs	V05 Single Float + Flag	0	5	NorthCPU	DNP3G30V05[0]	...	<input checked="" type="checkbox"/>	V07 Single Float ...	1	3600	Default	<input type="checkbox"/>
<input type="checkbox"/>													<input type="checkbox"/>

Figure 6.14 – Enable Events

Selecting an Event Variation

The *Event Variation* must be selected. Note that if “with Time” is selected, the logging of an event will be timestamped.

Tag Mapping Items (max. of 1000 items.)

En	Group	Variation	Index Start	Index Count	Target Name	Target Tag	Browse	Enable Events	Evt Variation	DB	Log Time	Class	Forced Unsol.
<input checked="" type="checkbox"/>	G030 AnalogInputs	V05 Single Float + Flag	0	5	NorthCPU	DNP3G30V05[0]	...	<input checked="" type="checkbox"/>	V07 Single Float ...	1	3600	Default	<input type="checkbox"/>
<input type="checkbox"/>													<input type="checkbox"/>

Figure 6.15 – Select variation

Selecting a Deadband (DB)

The *Deadband (DB)* must be configured. When the value changes by more than the deadband, an event is logged.

Tag Mapping Items (max. of 1000 items.)

En	Group	Variation	Index Start	Index Count	Target Name	Target Tag	Browse	Enable Events	Evt Variation	DB	Log Time	Class	Forced Unsol.
<input checked="" type="checkbox"/>	G030 AnalogInputs	V05 Single Float + Flag	0	5	NorthCPU	DNP3G30V05[0]	...	<input checked="" type="checkbox"/>	V07 Single Float ...	1	3600	Default	<input type="checkbox"/>
<input type="checkbox"/>													<input type="checkbox"/>

Figure 6.16 – Select deadband

Selecting a Log Time

The *Log Time* must be configured. If no event for that mapped item has been logged for more than the Log Time, then the mapped items are logged. A value of zero disables the Log Time functionality.

Tag Mapping Items (max. of 1000 items.)

En	Group	Variation	Index Start	Index Count	Target Name	Target Tag	Browse	Enable Events	Evt Variation	DB	Log Time	Class	Forced Unsol.
<input checked="" type="checkbox"/>	G030 AnalogInputs	V05 Single Float + Flag	0	5	NorthCPU	DNP3G30V05[0]	...	<input checked="" type="checkbox"/>	V07 Single Float ...	1	3600	Default	<input type="checkbox"/>
<input type="checkbox"/>													<input type="checkbox"/>

Figure 6.17 – Select log time

Selecting the Event Class

The *Event Class* for each group must be selected. This will be used by the Master to enable unsolicited responses. The class can be select per mapped item by selecting the Class (as shown below):

En	Group	Variation	Index Start	Index Count	Target Name	Target Tag	Browse	Enable Events	Evt Variation	DB	Log Time	Class	Forced Unsol.
<input checked="" type="checkbox"/>	G030 AnalogInputs	V05 Single Float + Flag	0	5	NorthCPU	DNP3G30V05[0]	...	<input checked="" type="checkbox"/>	V07 Single Float ...	1	3600	Default	<input type="checkbox"/>

Figure 6.18 – Select Event Class per mapped item

If the default is selected, the user will need to select a class for a specific Event Group (as shown below):

Unsolicited Response Qualifier: Default

Unsolicited Event Triggers

	Max. Count	Max. Time (s)
Class 1	<input type="text" value="1"/>	<input type="text" value="2"/>
Class 2	<input type="text" value="1"/>	<input type="text" value="2"/>
Class 3	<input type="text" value="1"/>	<input type="text" value="2"/>

Outstation Events

Max Unload Count: [1-250]

Max Event / Group: [10-100,000]

Outstation Default Event Classes

G02 Binary Inputs: Class1

G04 Double Binary Inputs: Class1

G11 Binary Outputs: Class1

G13 Binary Output Commands: Class1

G22 Counters: Class1

G23 Frozen Counters: Class1

G32 Analog Inputs: Class1

G42 Analog Output Status: Class1

G43 Analog Output Commands: Class1

Figure 6.19 – Select Event Class per Group

IMPORTANT: The PLX51-DNPS supports assigning of event classes dynamically by the DNP3 Master. If an Assign Class request is received which differs from the current implementation, then all events in the module will be cleared.

Selecting the Unsolicited Responses

For each mapped item unsolicited responses can be enabled. This will allow the module to send report-by-exception data without the DNP Master having to enable it.

En	Group	Variation	Index Start	Index Count	Target Name	Target Tag	Browse	Enable Events	Evt Variation	DB	Log Time	Class	Forced Unsol.
<input checked="" type="checkbox"/>	G030 AnalogInputs	V05 Single Float + Flag	0	5	NorthCPU	DNP3G30V05[0]	...	<input checked="" type="checkbox"/>	V07 Single Float ...	1	3600	Default	<input type="checkbox"/>

Figure 6.20 – Select Unsolicited Responses

NOTE: If the Target Address has **not** been forced in the configuration, the DNP Master will need to send at least one Enable Unsolicited Responses for the module to start sending unsolicited responses.

Selecting the Unsolicited Response Qualifier

The *Unsolicited Response Qualifier* depends on the format supported by the remote DNP3 master.

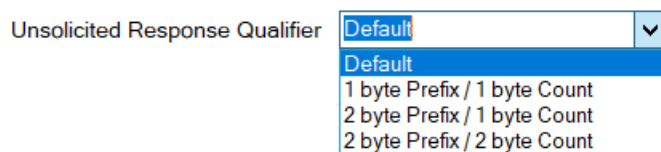

Figure 6.21 – Select Unsolicited Response Qualifier

Selecting the unsolicited Event Triggers

The *Event Triggers* can be used by the PLX51-DNPS to limit the amount of individual unsolicited responses sent to the DNP3 Master. To reduce traffic, you can set limits, which must be reached before an unsolicited response is sent.

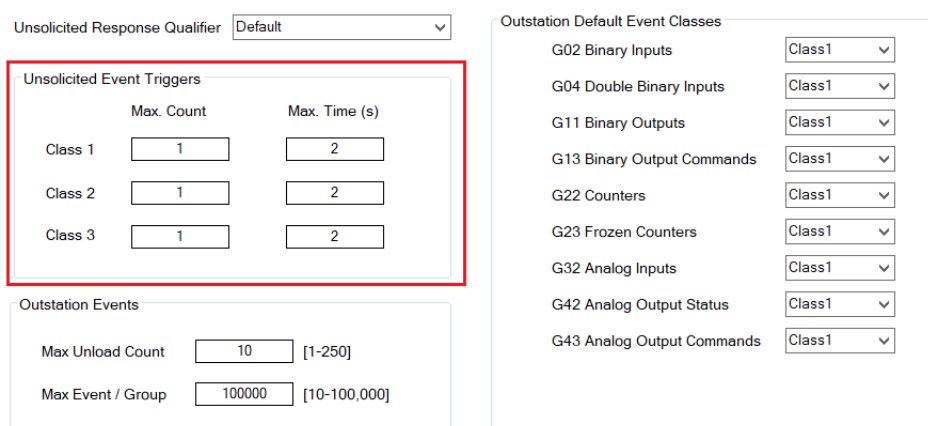

Figure 6.22 – Selecting Event Triggers

6.5 Report-By-Exception

Reporting by Exception can considerably reduce network traffic by eliminating or reducing continuous polling.

Reporting by exception can be configured by, enabling Events in each Outstation for all relevant groups. The DNP3 Master needs to have Events enabled in Unsolicited Class mode.

At least one Logix Tag Mapping is required to set the Logix Target. This item’s scan interval can be set to a large number.

6.6 Outstation Time Needed

The PLX51-DNPS can be forced to set the *Time Needed* bit in the DNP3 indicators when responding to a request. This will inform the DNP3 Master that it must write the current time to the PLX51-DNPS. When the PLX51-DNPS powers up, the *Time Needed* bit will be set by default. The *Time Needed* bit can be forced by using a CIP explicit message from Logix.

The message instruction should be setup as follows:

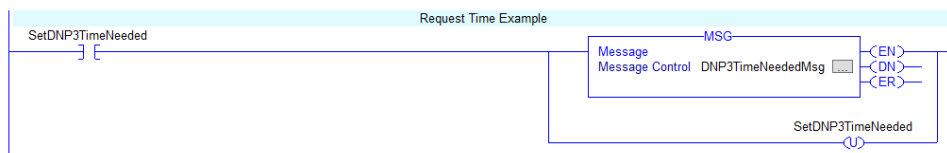

Figure 6.23 - Message instruction

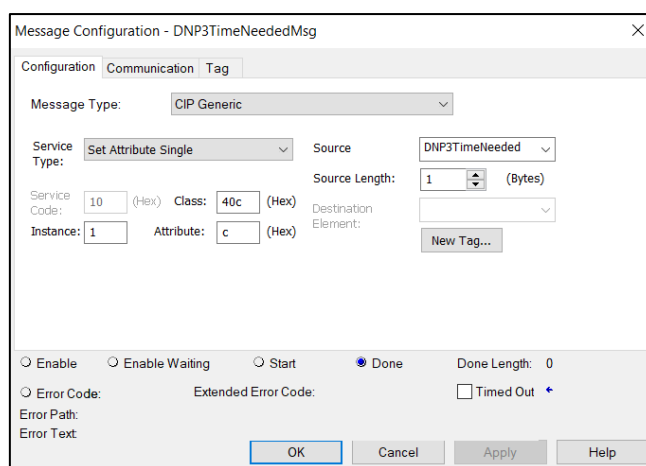

Figure 6.24 – Logix Message Configuration

Parameter	Description
Message Type	CIP Generic
Service Type	Set Single Attribute
Service Code	10 (Hex) – Set Single Attribute
Class	40C (Hex)
Instance	1
Attribute	C (Hex)
Source Element	SINT
Source Length	1
Destination Element	None

Table 6.8 - Message Configuration paramaters

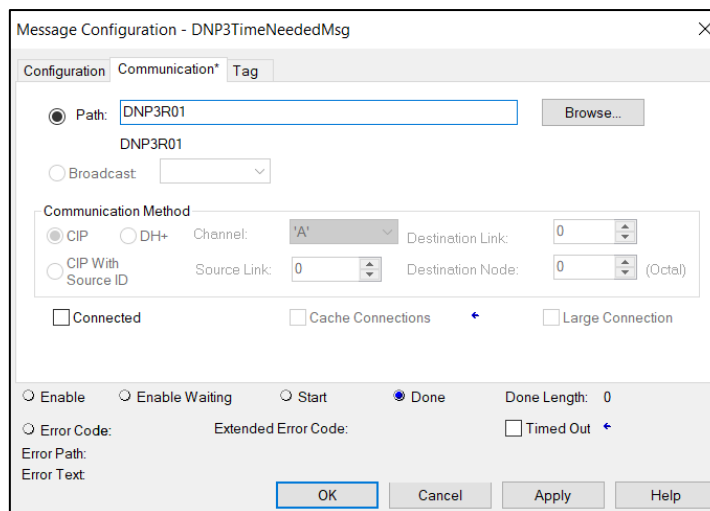

Figure 6.25 - Message Configuration - Communication

The Path must be configured to that of the PLX51-DNPS module. If the PLX51-DNPS has been added in the I/O tree, then the Browse option can be used to select the path.

Alternatively, enter the CIP path in the format **1,X,2,IP**, where:

- 1 represents the backplane port,
 - X represents the slot of the Ethernet bridge module,
 - 2 represents the Ethernet port of the Ethernet bridge module and
 - IP represents the IP address of the PLX51-DNPS module.
- e.g. 1,1,2,192.168.1.41

The request source tag (e.g. **DNP3TimeNeeded**) should be configured as follows:

+ DNP3TimeNeeded	1	Decimal	SINT
------------------	---	---------	------

Figure 6.26 - Unscheduled message request source tag

Parameter	Description
DNP3TimeNeeded	0 – Force the Time Needed bit in the DNP3 Indicators to off 1 – Force the Time Needed bit in the DNP3 Indicators to on

Table 6.9 - Unscheduled message request parameters

6.7 Dual DNP3 Master Event Unloading

The PLX51-DNPS module can unload DNP events to two DNP Masters. This is used to allow for redundant Masters to communicate with a single DNP Outstation without losing events. The DNPs will keep track of each DNP Master event unloading such that even if one of the DNP Masters go offline for a while and come back, it would not have lost any events, while the other DNP Master was still active and unloading events.

To activate Dual Master Event unloading the *Enable Dual Master Event Unloading* option must be selected (as shown below). Two DNP Masters will also need to be configured in the Dual Master List.

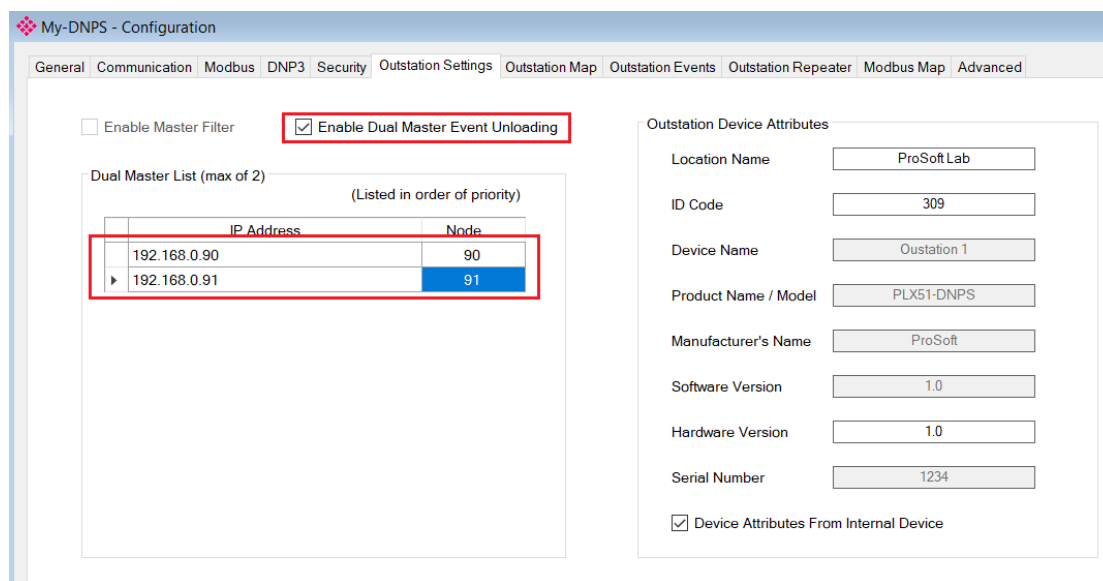

Figure 6.27 – Dual Master Event Unloading parameters

The number of DNP events buffered will be determined by the DNP Master that has unloaded the least number of events. If the number of events logged (that have not been unloaded by either of the DNP Masters) reaches the max event log size.

The user can decide to either keep logging events, in which case the DNP Master which has the least number unloaded will start to lose events or stop logging until the DNP Master with the least number of events unloaded starts unloading events.

This can be tracked in the viewing the *Event Statistics* in the Status window of the PLX50CU. The *Events Statistics* will show the number of events that have not been unloaded for each Master, for each Group, per class.

Event Statistics														Clear Events	
Group	C1 Load	C1M1 Count	C1M1 Addr	C1M2 Count	C1M2 Addr	C2 Load	C2M1 Count	C2M1 Addr	C2M2 Count	C2M2 Addr	C3 Load	C3M1 Count	C3M1 Addr	C3M2 Count	C3M2 Addr
G02	000:00:00	0	000:00:00	0	000:00:00	000:00:00	0	000:00:00	0	000:00:00	000:00:00	0	000:00:00	0	000:00:00
G04	000:00:00	0	000:00:00	0	000:00:00	000:00:00	0	000:00:00	0	000:00:00	000:00:00	0	000:00:00	0	000:00:00
G11	000:00:00	0	000:00:00	0	000:00:00	000:00:00	0	000:00:00	0	000:00:00	000:00:00	0	000:00:00	0	000:00:00
G13	009:09:14	48873	011:27:05	0	000:00:00	000:00:00	0	000:00:00	0	000:00:00	000:00:00	0	000:00:00	0	000:00:00
G22	000:00:00	0	000:00:00	0	000:00:00	000:00:00	0	000:00:00	0	000:00:00	000:00:00	0	000:00:00	0	000:00:00
G23	000:00:00	0	000:00:00	0	000:00:00	000:00:00	0	000:00:00	0	000:00:00	000:00:00	0	000:00:00	0	000:00:00
G32	032:21:02	2002	030:24:00	0	000:00:00	000:00:00	0	000:00:00	0	000:00:00	000:00:00	0	000:00:00	0	000:00:00
G42	000:00:00	0	000:00:00	0	000:00:00	000:00:00	0	000:00:00	0	000:00:00	000:00:00	0	000:00:00	0	000:00:00
G43	000:00:00	0	000:00:00	0	000:00:00	007:61:03	48806	010:18:13	0	000:00:00	000:00:00	0	000:00:00	0	000:00:00

Figure 6.28 – Dual Master Event Unloading statistics

NOTE: Secure authentication cannot be used with Dual Master Event Unloading.

6.8 Outstation Local Time Update

The PLX51-DNPS module time can be locally updated by a Logix controller using a CIP Explicit Message Instruction (MSG) in Logix. This will allow the PLX51-DNPS to synchronize it's time to the local Logix Controller. This might be useful in times where the DNP Master poll time is large and a outstation loses power. In this example, the PLX51-DNPS will startup when power is applied with the module year 1970, because it has not yet received time from the DNP Master.

IMPORTANT: It is not the norm for the DNP Outstation time to be locally updated, because time management and time update across the DNP network is managed by the DNP Master.

The message instruction should be setup as follows:

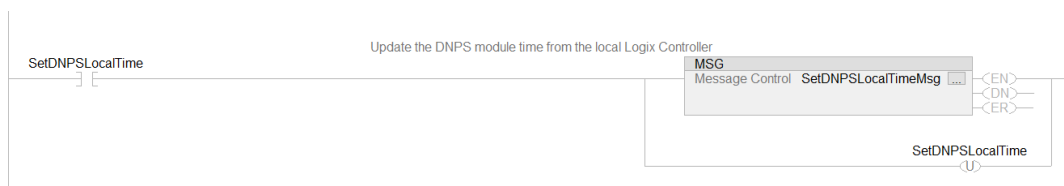

Figure 6.29 – Time Update Logix Message instruction

Figure 6.30 - Message Configuration

Parameter	Description
Message Type	CIP Generic
Service Type	Set Single Attribute
Service Code	10 (Hex) – Set Single Attribute
Class	404 (Hex)
Instance	1
Attribute	B (Hex)
Source Element Data Type	DINT[7]
Source Length	28
Destination Element	None

Table 6.10 - Message Configuration parameters

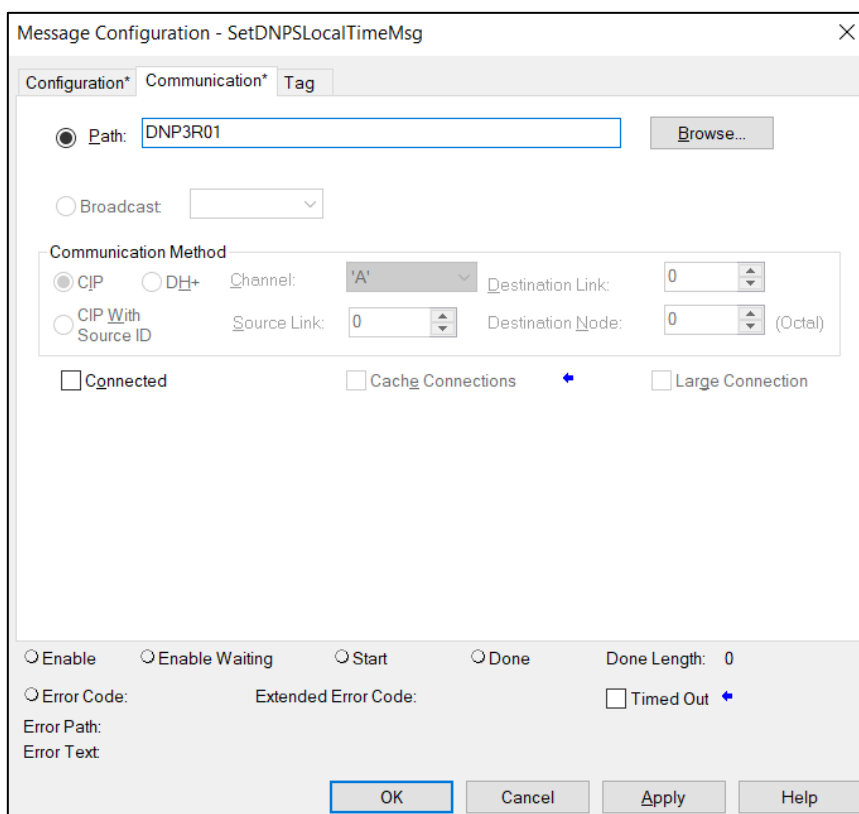

Figure 6.31 - Message Configuration - Communication

The Path must be configured to that of the PLX51-DNPS module. If the PLX51-DNPS has been added in the I/O tree, then the Browse option can be used to select the path.

Alternatively, enter the CIP path in the format **1,X,2,IP**, where:

- 1** represents the backplane port,
 - X** represents the slot of the Ethernet bridge module,
 - 2** represents the Ethernet port of the Ethernet bridge module and
 - IP** represents the IP address of the PLX51-DNPS module.
- e.g. 1,1,2,192.168.1.41

The request source tag (e.g. **UpdateTime**) should be configured as follows:

▲ UpdateTime	{...}	{...}	Decimal	DINT[7]	
▶ UpdateTime[0]	2022		Decimal	DINT	Year
▶ UpdateTime[1]	6		Decimal	DINT	Month
▶ UpdateTime[2]	20		Decimal	DINT	Day
▶ UpdateTime[3]	17		Decimal	DINT	Hour
▶ UpdateTime[4]	27		Decimal	DINT	Minute
▶ UpdateTime[5]	33		Decimal	DINT	Second
▶ UpdateTime[6]	0		Decimal	DINT	MicroSecond

Figure 6.32 - Unscheduled message request source tag

7 Modbus Operation

When the PLX51-DNPS has been configured for Modbus communication, it will function as a Modbus Master or Modbus Slave.

7.1 Message Routing

The DNP3 message initiator will send a read/write to a certain DNP3 group and variation. It will then be read/written to the mapped Modbus registers. The messages sent by the initiator must be completed with the correct data for successful operation. There are various indicators to determine if the mapping is routing the DNP3 messages correctly. Refer to the [“Diagnostics”](#) section for more information.

7.2 DNP Status

The PLX51-DNPS will provide the general module status at the configured DNP Status Register (see the “Modbus” section in the [“PLX51-DNPS Configuration”](#) section). The format of both HR/IR and CS/IS mapping is shown below.

Field	CS/IS Offset	HR/IR Offset	CS/IS Size	HR/IR Size	Data Type	Description
DNP Status - General	0	0	16	1	BOOL	Bit 0 - DNP Slave Mode Bit 1 - DNP Master Mode Bit 2 - DNP Unscheduled Mode Bit 3 - DNP Config Valid Bit 4 - DNP Event Log Load Ok Bit 5 - DNP Event Log Overflow Bit 6 to 15 - Reserved

Table 7.1 – Modbus DNP Status format

NOTE: The *CS/IS Offset* or *HR/IR Offset* is the offset from the configured *DNP Info Register* in the Modbus Tab of the configuration as shown below:

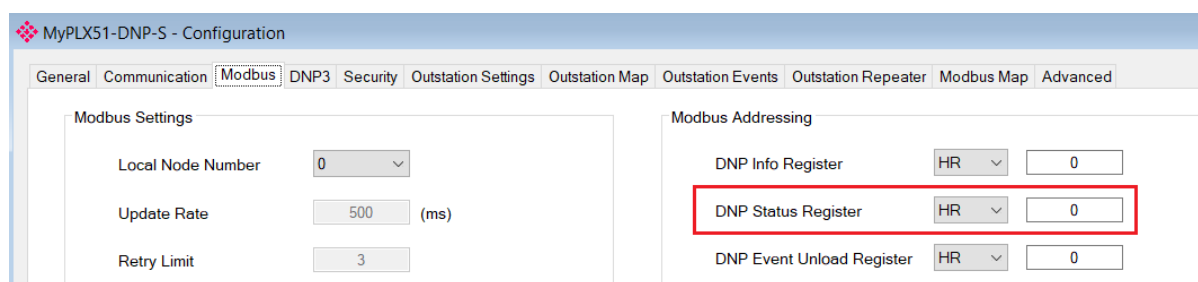

Figure 7.1 – Configured DNP Status Register

7.3 DNP Information

The PLX51-DNPS will provide the general module information at the configured *DNP Info Register* (see the “[Modbus](#)” section in the “[PLX51-DNPS Configuration](#)” section). The format is shown below.

Field	HR/IR Offset	HR/IR Size	Data Type
DNP Status - Info - DNP Temperature	0	1	INT
DNP Status - Info - Application Msg Rx Count	1	2	DINT
DNP Status - Info - Application Msg Tx Count	3	2	DINT
DNP Status - Info - Checksum Error Count	5	2	DINT
DNP Status - Info - Message Timeout Count	7	2	DINT
DNP Status - Info - Authentication Failure Count	9	2	DINT
DNP Status - Info - Session Key Failure Count	11	2	DINT
DNP Status - Info - Master Event Unload Index NOTE: This is only relevant for the PLX51-DNPM.	13	2	DINT
DNP Status – Time – Year	15	1	INT
DNP Status – Time – Month	16	1	INT
DNP Status – Time – Day	17	1	INT
DNP Status – Time – Hour	18	1	INT
DNP Status – Time – Minute	19	1	INT
DNP Status – Time – Second	20	1	INT

Table 7.2 – Modbus DNP info format

NOTE: The HR/IR Offset is the offset from the configured *DNP Info Register* in the Modbus Tab of the configuration as shown below:

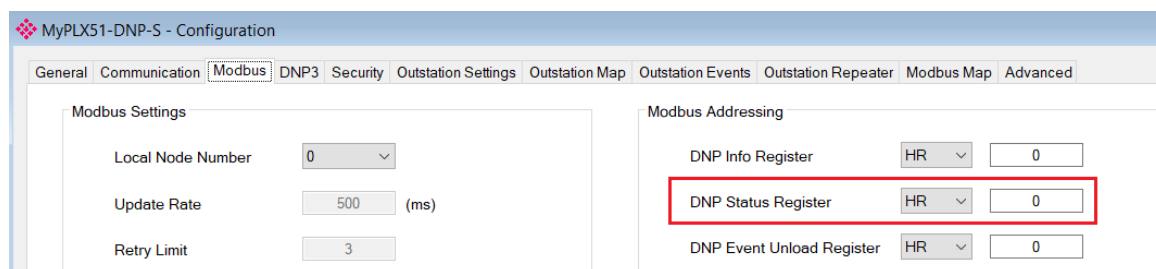

Figure 7.2 – Configured DNP Status Register

8 DNP3 Dynamic Configuration

The PLX51-DNPS supports accepting of dynamic configuration from a DNP Master. This includes assigning classes, writing of Analog Deadbands, and enabling or disabling of unsolicited Responses. The module will apply these settings once received from the DNP Master.

NOTE: When dynamic configuration is received from a DNP Master (e.g., Assigning Classes, writing Analog Deadbands, or enabling/disabling of Unsolicited Responses) it will “overwrite” the existing static configuration which was downloaded to the PLX51-DNPS using the PLX50 configuration utility.

For example, if the user has configured a mapped item in the DNP mapping to have a DNP Event Class of 2 (as shown below) and a Assign Class is received for that mapped item (from a DNP Master) to assign Analog Input 0 to use DNP Event Class 3, then the PLX51-DNPS will log all new events for Analog Input 0 as DNP Class 3 Events (regardless of the Class configured in the DNP Mapping in PLX50CU).

Tag Mapping Items (max. of 1000 items.)														
	En	Group	Variation	Index Start	Index Count	Target Name	Target Tag	...	Enable Events	Evt Variation	DB	Log Time	Class	Forced Unsol.
▶ 1	<input checked="" type="checkbox"/>	G030 AnalogInputs	V01 32-bit + Flag	0	1	L8E	Analog	...	<input checked="" type="checkbox"/>	V01 32-bit ...	1	0	Class 2	<input type="checkbox"/>
*	<input type="checkbox"/>													<input type="checkbox"/>

The settings received will be applied to each data point and does not have to match the data points per mapping item. These settings can also persist by being saved to NV memory when setting the persist options in the DNP3 *Outstation Dynamic Configuration*.

The dynamic configuration can be uploaded from the device (when persisting is enabled) by selecting the *Export NV Dynamic Configuration*. This will generate a CSV file with all the dynamic configuration saved to Non-Volatile memory that is assigned to the module.

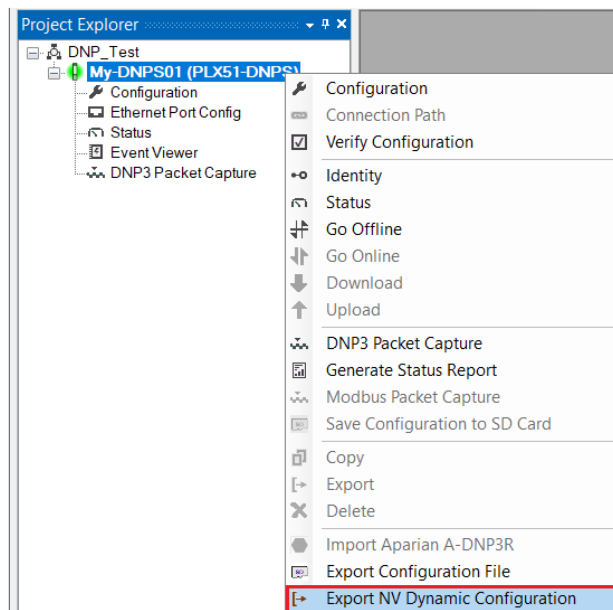

Figure 8.1 – Export NV Dynamic Configuration.

8.1 Assign Classes

The DNP Master can change the assigned event classes for each data point by sending a DNP assign class message. Once the assigned event classes have been received and validated it will be assigned to the required data points. The settings can be persisted by selecting the *Assigned Classes Persist* option in the DNP3 settings.

NOTE: Thus, if the module is power cycled or reset, then the dynamic configuration received from the DNP Master will again be applied at startup.

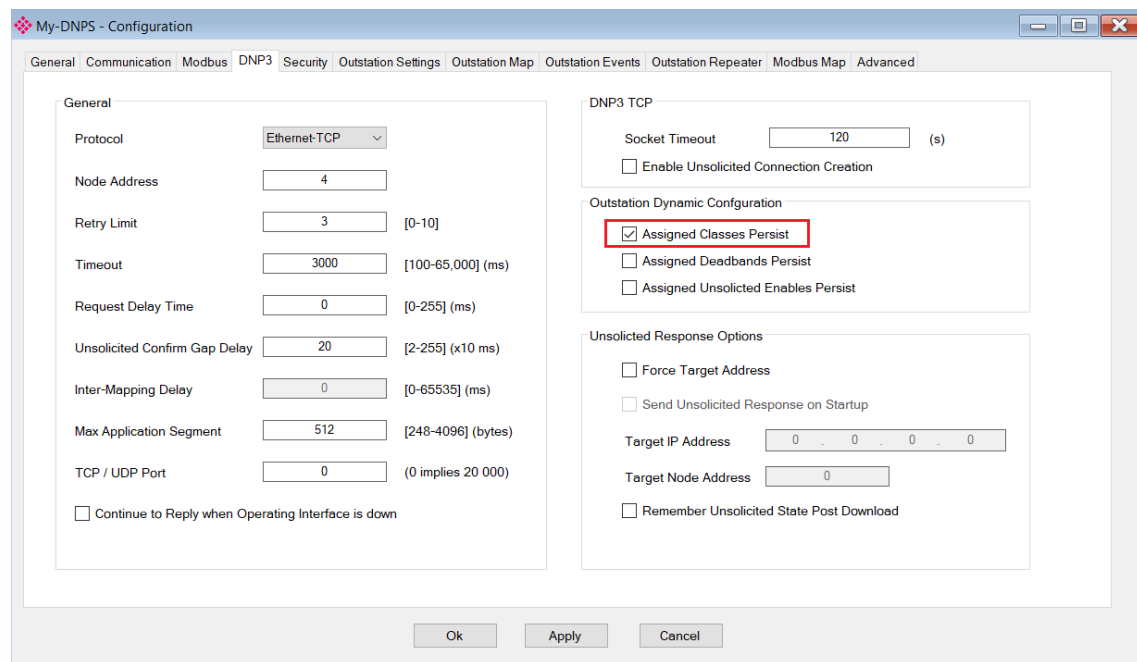

Figure 8.2 – Parameter to persist Assigned Classes

Once the assigned event classes have been successfully saved to NV memory and applied, the Dynamic Class Assignments will be *Active*.

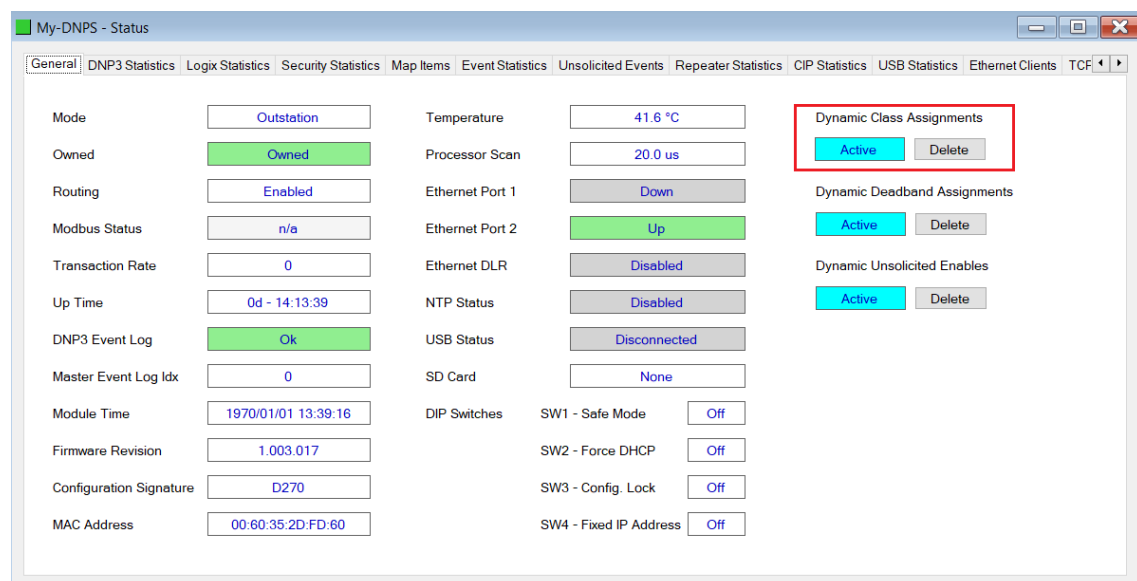

Figure 8.3 – Dynamic Config Active

Once the module has been power cycled, the settings will be reloaded and overwrite any settings for event classes that have been configured in the PLX50CU. The user can delete the dynamic settings by clicking the delete button. This will remove the dynamic configuration from the NV memory as well as reset the parameters back to the values configured in the PLX50CU.

NOTE: When a firmware update is done, the dynamic configuration will be deleted.

NOTE: When the mapping the PLX50CU is changed, the dynamic configuration will be deleted.

NOTE: When the persist enable checkbox is changed (selected or unselected) from the previous state and the configuration is downloaded from the PLX50CU to the PLX51-DNPS, then dynamic configuration will be deleted.

NOTE: When the DNPS receives an assign class command from a DNP Master, which will change the event classes for specific DNP mapped items, then **all existing buffered DNP events will be deleted**. The same operation (of deleting all buffered DNP events) is applied when deleting the Dynamic Class Assignments as the events classes will be returned to the PLX50CU configured event classes.

8.2 Written Analog Deadbands

The DNP Master can change the deadbands (used for triggering DNP events) for each mapped item by writing a new deadband for the specific data points. Once the analog deadbands have been received and validated it will be updated. The settings can be persisted by selecting the *Assigned Deadbands Persist* option in the DNP3 settings.

NOTE: Thus, if the module is power cycled or reset, then the dynamic configuration received from the DNP Master will again be applied at startup.

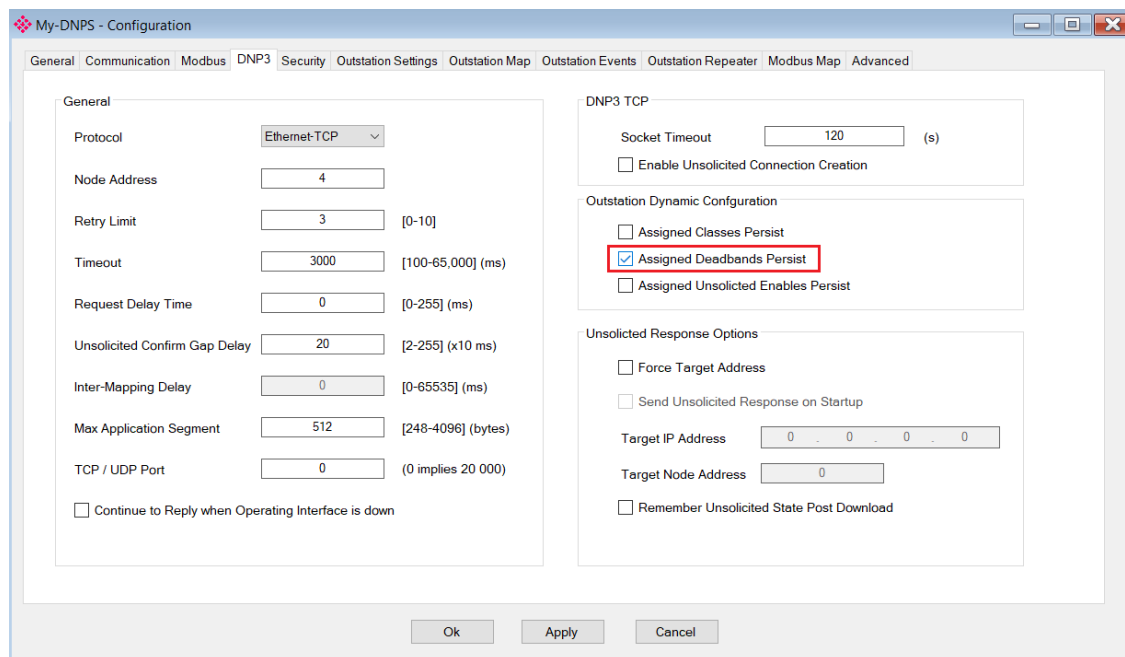

Figure 8.4 – Parameter to persist Assigned Deadbands

Once the analog deadbands have been successfully saved to NV memory and applied, the Dynamic Deadband Assignments will be *Active*.

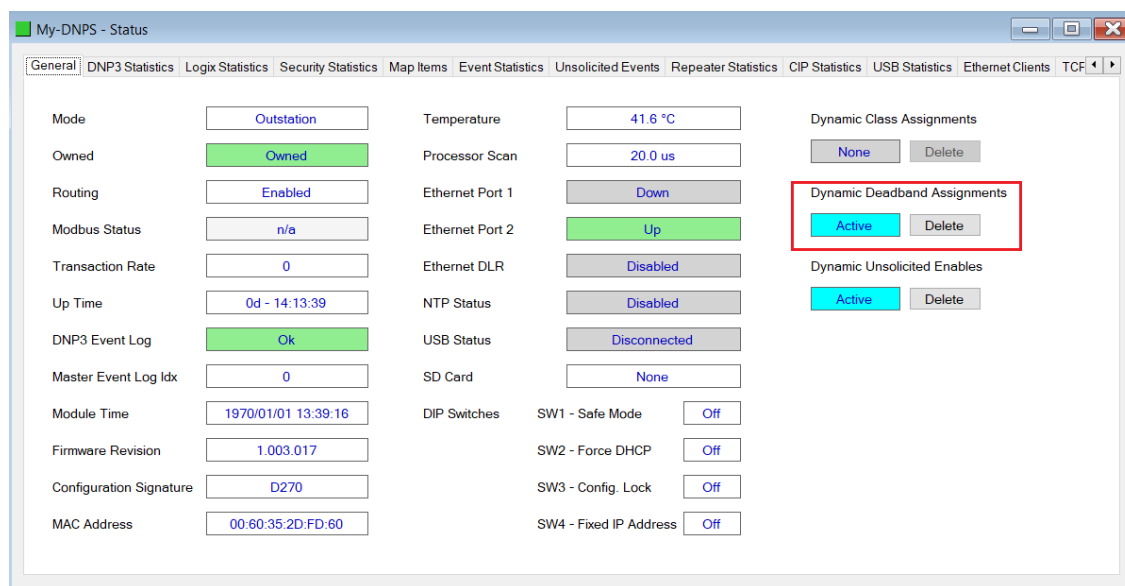

Figure 8.5 – Dyanmic Config Active

Once the module has been power cycled, the settings will be reloaded and overwrite any deadbands that have been configured in the PLX50CU. The user can delete the dynamic settings by clicking the delete button. This will remove the dynamic configuration from the NV memory as well as reset the parameters back to the values configured in the PLX50CU.

NOTE: When a firmware update is done, the dynamic configuration will be deleted.

NOTE: When the mapping the PLX50CU is changed, the dynamic configuration will be deleted.

NOTE: When the persist enable checkbox is changed (selected or unselected) from the previous state and the configuration is downloaded from the PLX50CU to the PLX51-DNPS, then dynamic configuration will be deleted.

8.3 Enabled/Disabled Unsolicited Responses

The DNP Master can enable or disable unsolicited responses for each mapped item by sending an enable or disable unsolicited request for the specific data points. Once the unsolicited response command has been received and validated it will be updated. The settings can be persisted by selecting the *Assigned Unsolicited Enables Persist* option in the DNP3 settings.

NOTE: Thus, if the module is power cycled or reset, then the dynamic configuration received from the DNP Master will again be applied at startup.

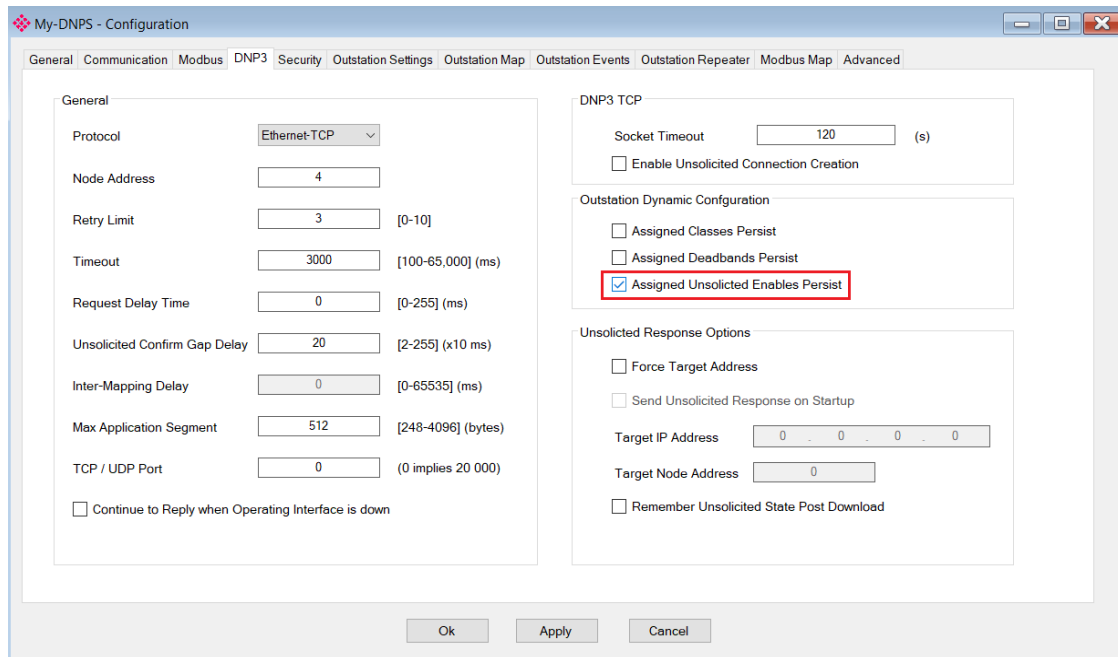

Figure 8.6 – Parameter to persist Assigned Unsolicited Enables

Once the unsolicited settings have been successfully saved to NV memory and applied, the Dynamic Unsolicited Enables will be *Active*.

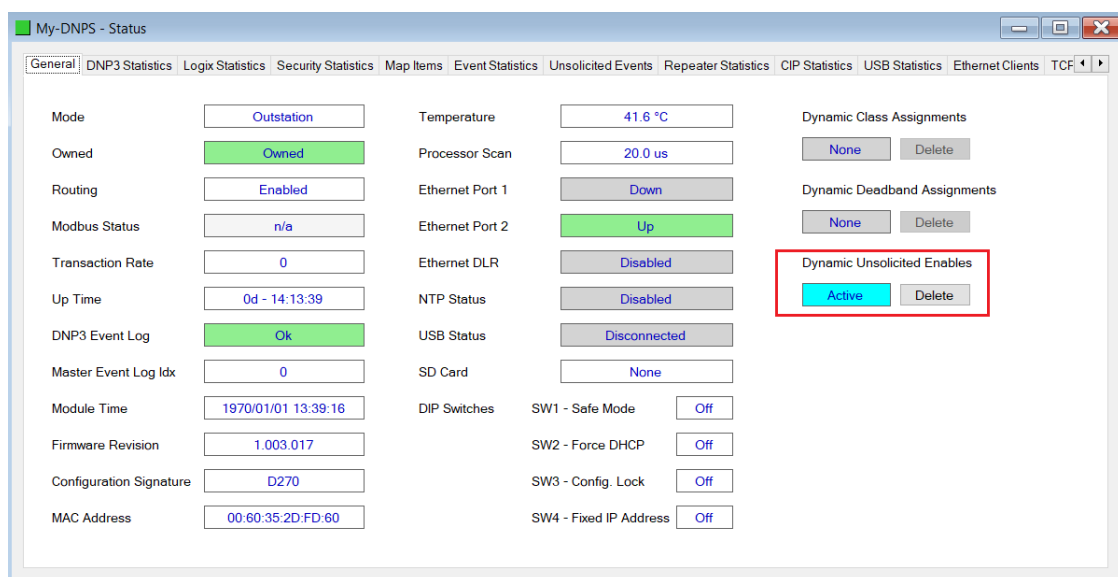

Figure 8.7 – Dyanmic Config Active

Once the module has been power cycled, the settings will be reloaded and overwrite any unsolicited settings that have been configured in the PLX50CU. The user can delete the dynamic settings by clicking the **Delete** button. This will remove the dynamic configuration from the NV memory as well as reset the parameters back to the values configured in the PLX50CU.

NOTE: When a firmware update is done, the dynamic configuration will be deleted.

NOTE: When the mapping the PLX50CU is changed, the dynamic configuration will be deleted.

NOTE: When the persist enable checkbox is changed (selected or unselected) from the previous state and the configuration is downloaded from the PLX50CU to the PLX51-DNPS, then dynamic configuration will be deleted.

NOTE: If the Target Address has **not** been forced in the configuration, the DNP Master will need to send at least one Enable Unsolicited Responses for the module to start sending unsolicited responses.

9 Security

DNP3 offers Secure Authentication for links at risk of being attacked. There are various Key Change methods, Message Authentication Code (MAC) algorithms, and Authentication methods provided in the DNP3 protocol specification.

Various keys are used in DNP3 Secure Authentication. **Session keys** are used most frequently as it is used for Authentication of the requests. These keys are updated by the DNP3 master at a certain interval or every time there has been a message failure. The DNP3 master encrypts these keys before sending them across the wire using the Key Wrap Algorithm selected and the **Update key**. The Update Key can be updated in numerous ways (including sending it across the wire with another set of Keys encrypting that message). The **Transfer Key** is used when you want to remotely change the update key of a PLX51-DNPS outstation. The Transfer Key is used to encrypt the Update Key being sent over the DNP3 network to the remote PLX51-DNPS module.

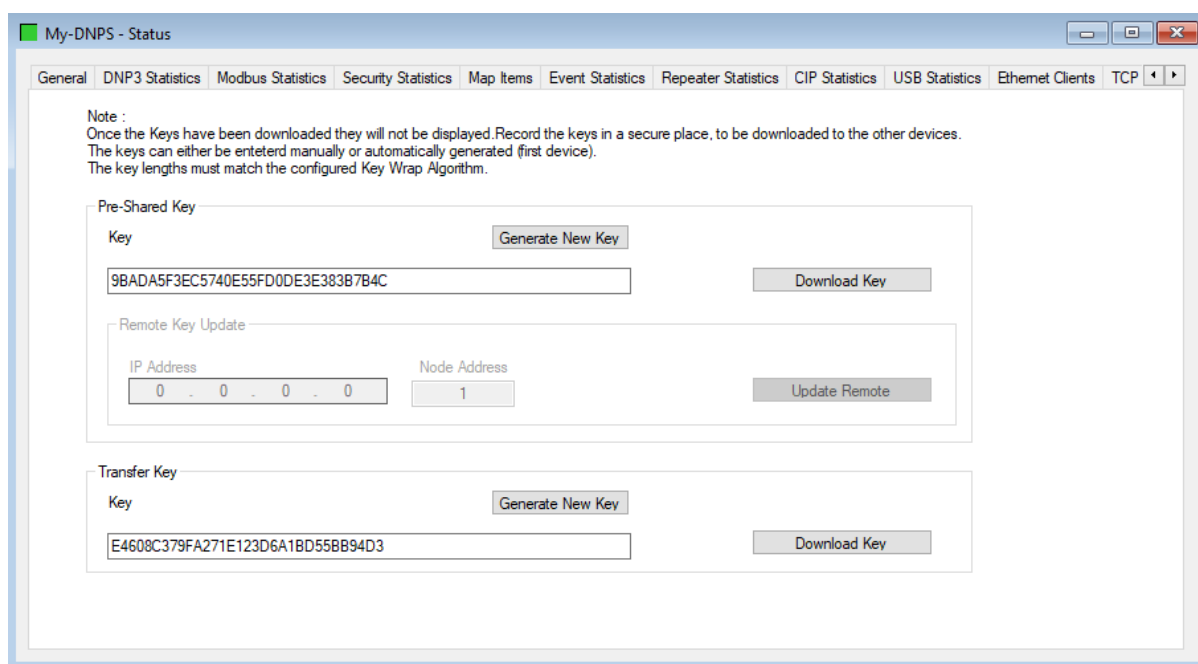

Figure 9.1 - PLX51-DNPS key update method.

The module supports all DNP3 MAC algorithms and Key Wrap algorithms. The module also supports Aggressive Authentication mode which reduces the amount of traffic on the network (which could be required on busy networks or serial communication).

IMPORTANT: You need to ensure that the other DNP3 device, with which it is communicating, has the same security options configured as the PLX51-DNPS. Also ensure that the selected options are supported in the device.

9.1 Key Updates

The PLX51-DNPS allows you to change the update key in one of two ways:

9.1.1 Local Key Update

You will need to be connected to the PLX51-DNPS and download the key directly from your PC to the module (over Ethernet).

In PLX50 Configuration Utility, you can write the Update Key to the PLX51-DNPS using the Key tab in the Online Status window.

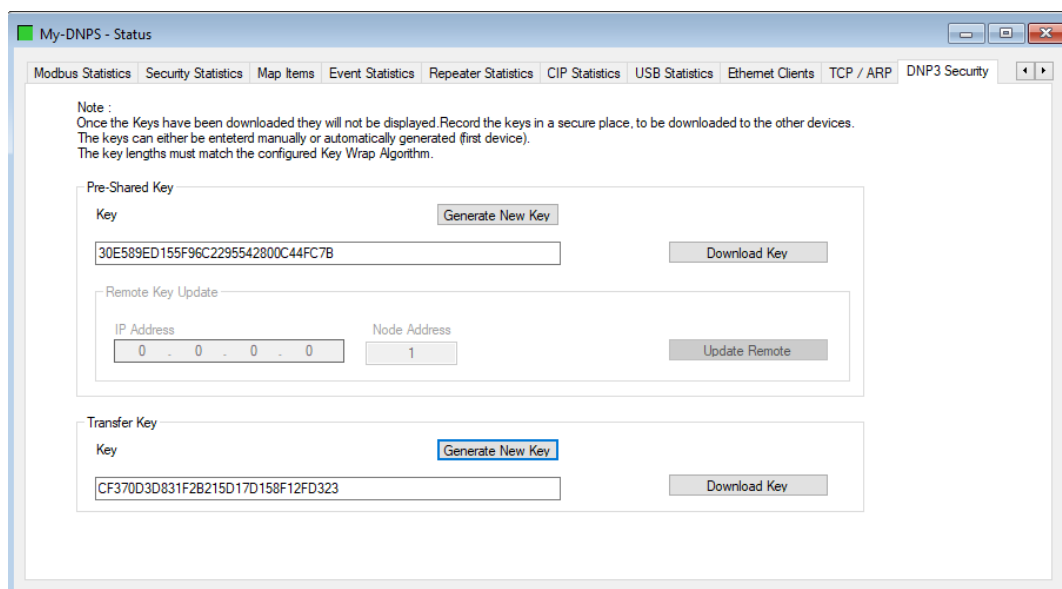

Figure 9.2 - PLX51-DNPS Update Key

The key entered must match the *Key Wrap Algorithm* selected. Thus, if AES-128 Key Wrap was selected the Update Key must be 128-bit (16 bytes). You can enter a predetermined hexadecimal code to create a new code in PLX50 Configuration Utility as shown below. This key is encrypted and sent to the PLX51-DNPS where it is saved into the NV memory of the module.

IMPORTANT: The Key update method in PLX50 Configuration Utility is a **write-only** function. Thus, once the key has been downloaded to the module, you will not be able to view the key again. You must make provisions to document or save the key in a secure manner.

IMPORTANT: The remote DNP3 device to be communicated to must have the same Update Key as that of the PLX51-DNPS. Failing to do this will result in failed data exchange for critical messages.

You can also change the update key from a Logix controller by using a MSG instruction. Note that unlike the key update from PLX50 Configuration Utility (which is downloaded securely), the update from Logix will not be secure and if the network is exposed, the update key can be accessed by an outside source.

IMPORTANT: You will **NOT** be able to change the update key using the unsecure method unless the *Allow Unsecure Key Download* option has been selected in the Security tab of the Configuration form.

Below are the MSG Instruction parameters to be used as well as the structure:

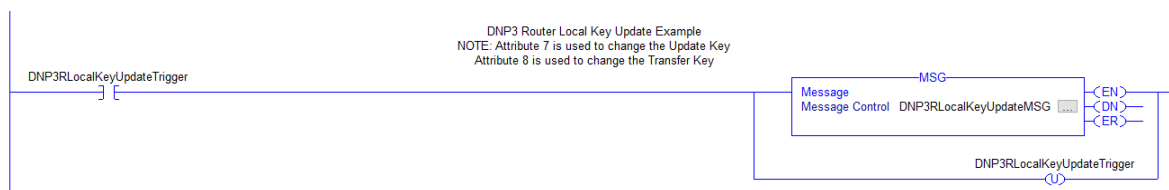

Figure 9.3 - Message instruction

Figure 9.4 - Message Configuration

Parameter	Description
Message Type	CIP Generic
Service Type	Set Attribute Single
Service Code	10 (Hex) – Set Single Attribute
Class	40C (Hex)
Instance	1
Attribute	7 – Update Key 8 – Transfer Key
Source Element	The request tag instance. Must follow the structure of the <i>PSDNP3LocalKeyUpdateRequest</i> UDT.
Source Length	33
Destination Element	N/A

Table 9.1 - Message Configuration parameters

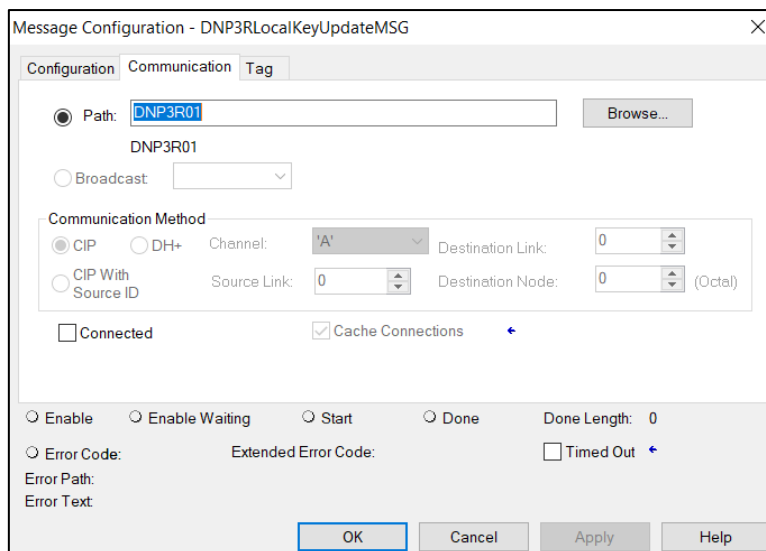

Figure 9.5 - Message Configuration - Communication

The Path must be configured to that of the PLX51-DNPS module. If the PLX51-DNPS has been added in the I/O tree, the Browse option can be used to select the path.

Alternatively, enter the CIP path in the format **1,X,2,IP**, where:

- 1 represents the backplane port,
 - X represents the slot of the Ethernet bridge module,
 - 2 represents the Ethernet port of the Ethernet bridge module and
 - IP represents the IP address of the PLX51-DNPS module.
- e.g. 1,1,2,192.168.1.41

The request tag (e.g. **PSDNP3RemoteKeyUpdateRequest**) should be configured as follows:

Name	Value	Style	Data Type
DNP3LocalKeyUpdateRequest	{...}		PSDNP3LocalKeyUpdateRequest
DNP3LocalKeyUpdateRequest.KeyLength	16	Decimal	SINT
DNP3LocalKeyUpdateRequest.KeyData	{...}	Decimal	SINT[32]

Figure 9.6 – Local key update message request tag

Parameter	Description
Key Length	Size of the key data to follow.
Key Data	The data for the key to be updated.

Table 9.2 - Local key update message request parameters

Similar to the update key, the transfer key can be changed from PLX50 Configuration Utility (securely) or from Logix (not-secured). The difference is that you will use attribute 8 to set the Transfer key, and attribute 7 (shown previously) for setting the update key.

IMPORTANT: You will **NOT** be able to change the transfer key using the unsecure method unless the *Allow Unsecure Key Download* option has been selected in the Security tab of the Configuration form.

9.1.2 Remote Key Update

The remote key update method allows you to remotely change the update key (used to create the session keys for authentication) by encrypting the update key with the transfer key. You will not be able to update the transfer key remotely (it will need to be downloaded to the module directly from the source).

IMPORTANT: You will not be able to remotely change the update key unless the *Key Change Method* option in the Security tab of the Configuration form has been set to: *Pre-Shared Key - Allow Remote Update*.

The PLX51-DNPS can operate in Master mode when the Update keys are changed remotely.

Operating Mode	Update Key Change Description
Master	Once the transfer key has been downloaded, you can click the Update Remote button in the DNP3 Security tab of the online status form in PLX50 Configuration Utility. This will inform the DNP3 Master to automatically change the update keys in each outstation mapped.

Table 9.3 – Operating mode for key updates

IMPORTANT: The PLX51-DNPS module will not be able to remotely change the update key if the transfer keys of the master and the outstation do not match.

The remote update key method can also be done from the Logix controller using a message instruction. Note that unlike the key update from PLX50 Configuration Utility (which is downloaded securely), the update from Logix will not be secure and if the network is exposed, the update key can be seen by an outside source.

The message instruction should be setup as follows:

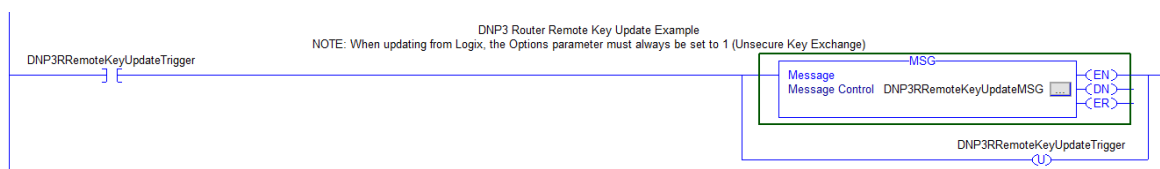

Figure 9.7 - Message instruction

Figure 9.8 - Message Configuration

Parameter	Description
Message Type	CIP Generic
Service Type	Custom
Service Code	6D (Hex) – Remote Key Update
Class	40C (Hex)
Instance	1
Attribute	0
Source Element	The request tag instance. Must follow the structure of the ProSoftTechnologyDNP3RemoteKeyUpdateRequest UDT.
Source Length	60
Destination Element	The response tag instance (DINT).

Table 9.4 - Message Configuration Paramaters

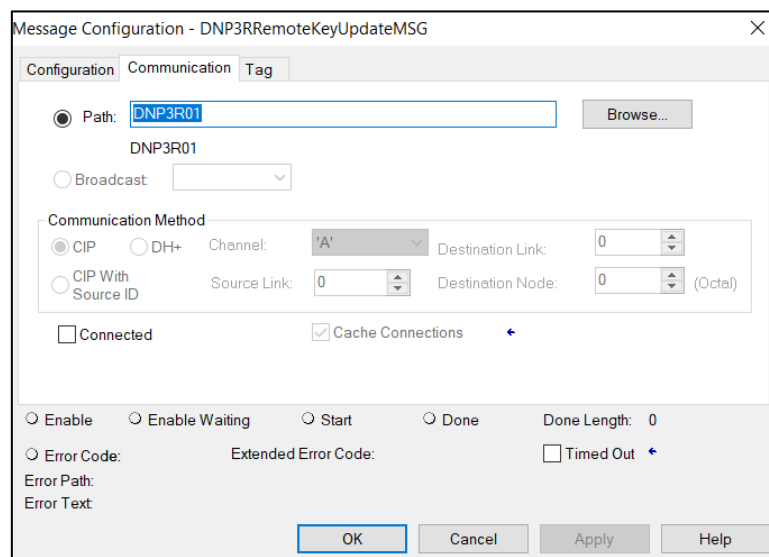

Figure 9.9 - Messagge Configuration - Communication

The Path must be configured to that of the PLX51-DNPS module. If the PLX51-DNPS has been added in the I/O tree, then the Browse option can be used to select the path.

Alternatively, enter the CIP path in the format **1,X,2,IP**, where:

- 1** represents the backplane port,
 - X** represents the slot of the Ethernet bridge module,
 - 2** represents the Ethernet port of the Ethernet bridge module and
 - IP** represents the IP address of the PLX51-DNPS module.
- e.g. 1,1,2,192.168.1.41

The request tag (e.g. **PSDNP3RemoteKeyUpdateRequest**) should be configured as follows:

Name	Value	Style	Data Type
DNP3RemoteKeyUpdateRequest	{ ... }		PSDNP3RemoteKeyUpdateRequest
DNP3RemoteKeyUpdateRequest.Command	1	Decimal	SINT
DNP3RemoteKeyUpdateRequest.Option	1	Decimal	SINT
DNP3RemoteKeyUpdateRequest.DestinationNode	3	Decimal	INT
DNP3RemoteKeyUpdateRequest.IPAddress	{ ... }	Decimal	INT[4]
DNP3RemoteKeyUpdateRequest.IPAddress[0]	192	Decimal	INT
DNP3RemoteKeyUpdateRequest.IPAddress[1]	168	Decimal	INT
DNP3RemoteKeyUpdateRequest.IPAddress[2]	1	Decimal	INT
DNP3RemoteKeyUpdateRequest.IPAddress[3]	222	Decimal	INT
DNP3RemoteKeyUpdateRequest.KeyData	{ ... }	Decimal	SINT[255]

Figure 9.10 – Remote key update message request tag

Parameter	Description
Command	N/A
Option	One of two options can be selected: 0 – Secure Key Exchange (not relevant for Logix MSG) 1 – Unsecure Key Exchange
Destination Node	N/A
IP Address	N/A
Key Data	SINT[0 – 14] – Reserved SINT[15] – Key length SINT[16-47] – Key Data

Table 9.5 - Remote key update message request parameters

RemoteKeyUpdateResponse	0	Decimal	DINT
-------------------------	---	---------	------

Figure 9.11 - Remote key update message response tag

Parameter	Description
DNP3 Indicators	These 16bits will provide return information of the remote DNP3 device. Refer to the DNP3 documentation in the "Additional Information" section. Bit 0 – Broadcast Bit 1 – Class 1 events Bit 2 – Class 2 events Bit 3 – Class 3 events Bit 4 – Need Time Bit 5 – Local control Bit 6 – Device trouble Bit 7 – Device restart Bit 8 – Function code not supported Bit 9 – Object unknown Bit 10 – Parameter error Bit 11 – Event buffer overflow Bit 12 – Already executing Bit 13 – Configuration corrupt Bit 14 – Reserved Bit 15- Reserved

Table 9.6 - Remote key update message response parameters

10 Diagnostics

10.1 LEDs

The PLX51-DNPS module provides LEDs for diagnostics purposes.

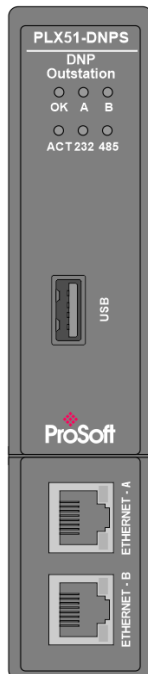

Figure 10.1 - PLX51-DNPS front view

LED	Description
Ok	<p>The module LED will provide information regarding the system-level operation of the module.</p> <p>If the LED is red, then the module is not operating correctly. For example, if the module application firmware has been corrupted or there is a hardware fault the module will have a red Module LED.</p> <p>If the LED is green (flashing), then the module has booted and is running correctly without any application configuration loaded.</p> <p>If the LED is green (solid), then the module has booted and is running correctly with application configuration loaded.</p>
A / B	<p>The Ethernet LED will light up when an Ethernet link has been detected (by plugging in a connected Ethernet cable). The LED will flash every time traffic is detected.</p> <p>This module has two Ethernet ports A and B. Each LEDs represents each specific port.</p>
Act	<p>The activity LED is used for the DNP3 Routing. Every time there is a successful DNP3 routing transaction the LED will flash green. The LED will flash red if the routing was unsuccessful (e.g. Logix Tag does not exist).</p>
232	<p>The 232 LED is used for the RS232 port. Every time there is a successful DNP3 packet on RS232 the LED will flash green. The LED will flash red if the DNP3 packet failed (e.g. checksum failure).</p>
485	<p>The 485 LED is used for the RS485 port. Every time there is a successful DNP3 packet on RS485 the LED will flash green. The LED will flash red if the DNP3 packet failed (e.g. checksum failure).</p>

Table 10.1 - Module LED operation

10.2 Module Status Monitoring in PLX50 Configuration Utility

The PLX51-DNPS module provides a range of statistics which can assist with module operation, maintenance, and fault finding. The statistics can be accessed in full by PLX50 Configuration Utility or using the web server in the module.

To view the module’s status in the ProSoft Technology PLX50 Configuration Utility environment, the module must be Online. If the module is not already Online (following a recent configuration download), then right-click on the module and select the **Go Online** option.

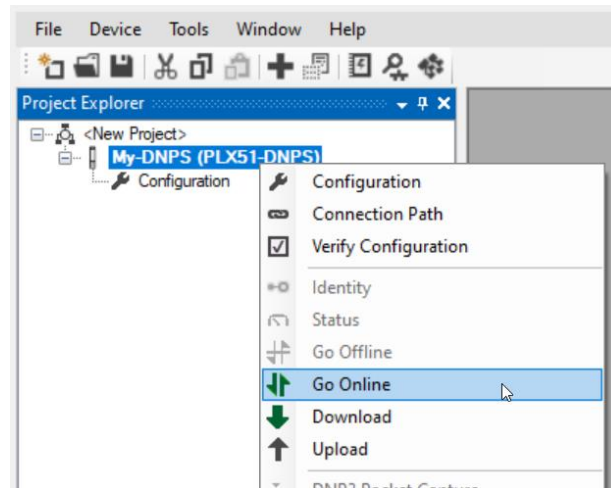

Figure 10.2 - Selecting to Go Online

The Online mode is indicated by the green circle behind the module in the Project Explorer tree.

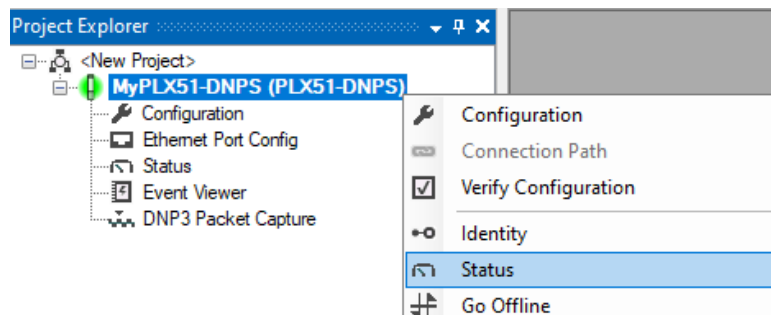

Figure 10.3 - Selecting online Status

The Status monitoring window can be opened by either double-clicking on the **Status** item in the Project Explorer tree, or by right-clicking on the module and selecting **Status**.

The status window contains multiple tabs to display the current status of the module.

10.2.1 General

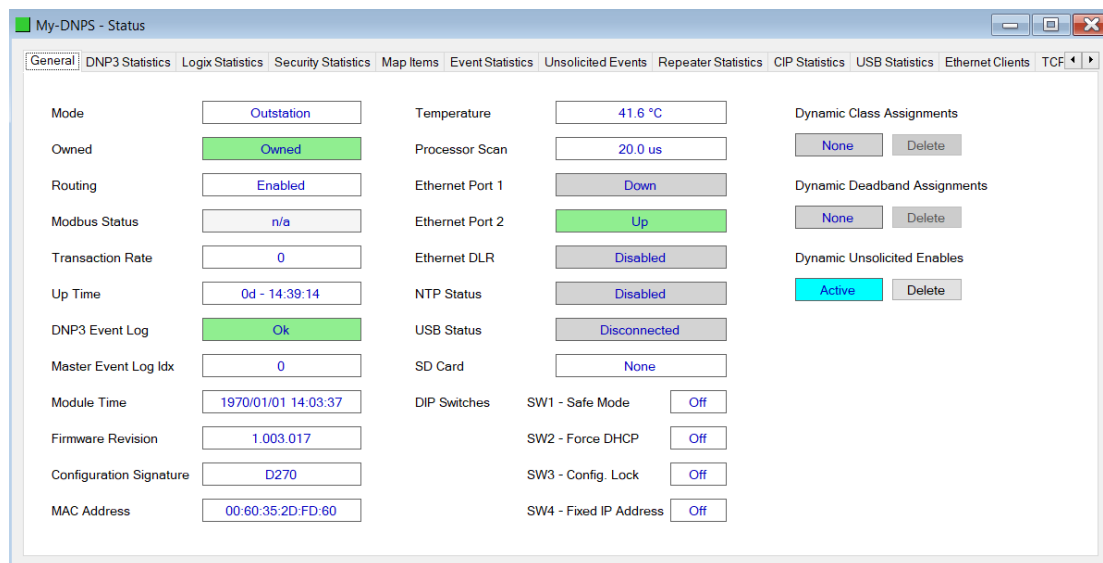

Figure 10.4 – General status

The General tab displays the following general parameters:

Parameter	Description
Mode	Indicates the current operating mode.
Owned	Indicates whether or not the module is currently owned (Class 1) by a Logix controller. (EtherNet/IP Logix only)
Routing	Indicates whether the routing of module is enabled or inhibited. The routing operation can be inhibited in the output assembly of the module. (EtherNet/IP only)
Modbus Status	Indicates the Status of the Modbus communication: <ul style="list-style-type: none"> ▪ Ok ▪ Fail
Transaction Rate	The transaction rate is the number of DNP3 messages per second that the module is currently routing.
Up Time	Indicates the elapsed time since the module was powered-up.
DNP3 Event Log	This is the current status of the DNP3 Event Log. It will indicate if there was a fault whilst loading the DNP3 Event Log or if there is an overflow on any of the Event Buffers.
Master Event Log Index	N/A
Module Time	Indicates the module’s internal time. The module time is stored in UTC (Universal Coordinate Time) but displayed on this page according to the local PC’s Time Zone settings.
Firmware Revision	The revision of the main application firmware.
Configuration Signature	The CRC of the module’s current configuration.
MAC Address	Displays the module’s unique Ethernet MAC address.
Temperature	The internal temperature of the module.
Processor Scan	The amount of time (microseconds) taken by the module’s processor in the last scan.
Ethernet Port 1 / 2	This is the status of each Ethernet port. Down The Ethernet connector has not been successfully connected to an Ethernet network. Up

	<p>The Ethernet connector has successfully connected to an Ethernet network.</p> <p>Mirror Enabled The Ethernet port is mirroring the traffic on the other Ethernet port.</p>
Ethernet DLR	<p>The status of the Ethernet DLR.</p> <p>Disabled Device Level Ring functionality has been disabled.</p> <p>Linear The DLR functionality has been enabled and the Ethernet network architecture is linear.</p> <p>Ring – Fault The DLR functionality has been enabled and the Ethernet network architecture is ring, but there is a fault with the network.</p> <p>Ring – Ok The DLR functionality has been enabled and the Ethernet network architecture is ring and is operating as expected.</p>
NTP Status	N/A
USB Status	<p>The status of the USB connection</p> <p>Connected The USB cable is connected to the PLX51-DNPS and partner.</p> <p>Disconnected The USB cable is not connected to either the PLX51-DNPS or partner.</p>
DIP Switch Position	<p>The status of the DIP switches when the module booted.</p> <p>Note that this status will not change if the DIP switches are altered when the module is running.</p>
Dynamic Class Assignments	<p>If the module has received dynamic configuration (assigned event classes) and the dynamic config is active and set to persist, this parameter will show <i>Active</i>.</p>
Dynamic Deadband Assignments	<p>If the module has received dynamic configuration (written analog deadbands) and the dynamic config is active and set to persist, this parameter will show <i>Active</i>.</p>
Dynamic Unsolicited Enables	<p>If the module has received dynamic configuration (enabled/disabled unsolicited responses) and the dynamic config is active and set to persist, this parameter will show <i>Active</i>.</p>

Table 10.2 - General status

10.2.2 DNP3 Statistics

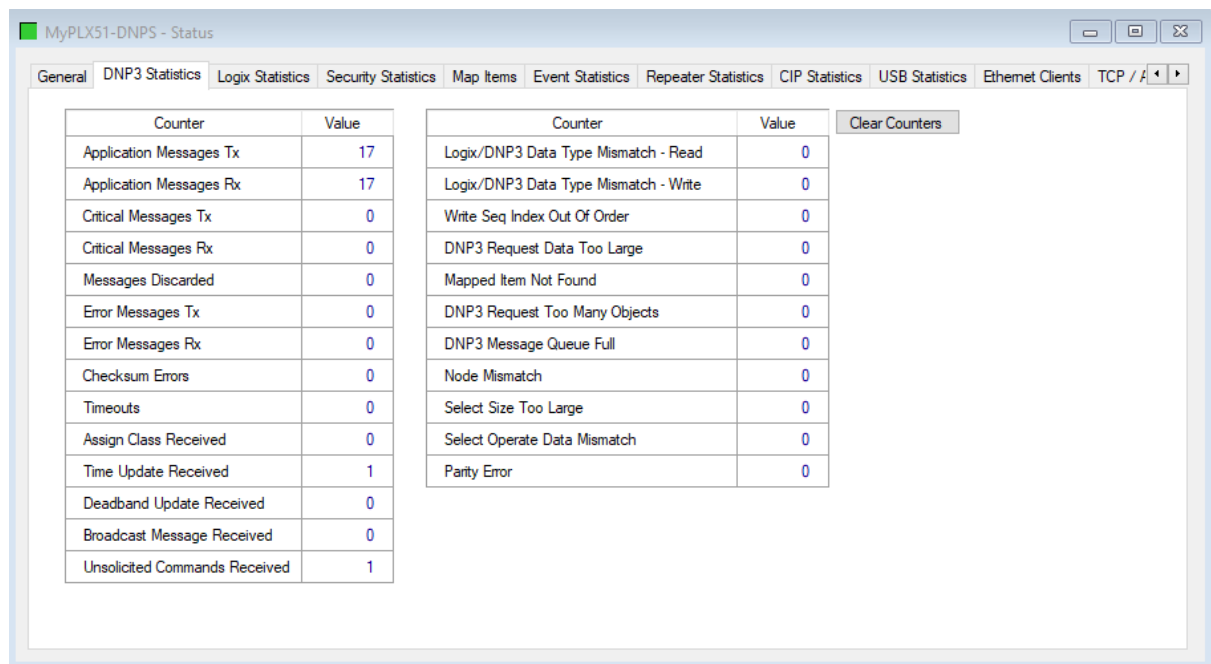

Figure 10.5 – DNP3 Statistics

The DNP3 tab displays the DNP3 communication statistics:

Statistic	Description
Application Messages Tx	The number of application DNP3 packets sent by the module.
Application Messages Rx	The number of application DNP3 packets received by the module.
Critical Messages Tx	The number of critical DNP3 packets sent by the module when security is enabled.
Critical Messages Rx	The number of critical DNP3 packets received by the module when security is enabled.
Messages Discarded	The number of DNP3 packets discarded by the module.
Error Messages Tx	The number of error DNP3 packets sent by the module.
Error Messages Rx	The number of error DNP3 packets received by the module.
Checksum Errors	The number of corrupted DNP3 packets received by the module.
Timeouts	The number of message response timeouts the module has encountered.
Assign Class Received	The number of assign class messages received.
Time Update Received	This number is the amount of times the DNP3 Master has sent a time update command to the DNP3 Outstation.
Deadband Update Received	N/A.
Broadcast Message Received	This is the number of DNP3 Broadcast messages received.
Unsolicited Command Received	This is the number of DNP3 Unsolicited (enable or disable) commands received.
Logix/DNP3 Data Type Mismatch - Read	The data type in Logix (atomic or UDT) did not match the DNP3 data type during a read operation.
Logix/DNP3 Data Type Mismatch - Write	The data type in Logix (atomic or UDT) did not match the DNP3 data type during a write operation.
Write Seq Index Out Of Order	DNP3 allows you to write data in a non-sequential manner by using DNP3 object prefixes. For example, a single write operation can be targeted to array offset 2, 3, 4, and 8. This is not allowed in the PLX51-DNPS due to the nature of the CIP communication protocol.

	You will need to write array offset 2, 3, and 4 and then in a separate write function write to offset 8.
DNP3 Request Data Too Large	The request data is too big. The PLX51-DNPS allows for a maximum of 1000 bytes per transaction.
Mapped Item Not found	The DNP3 request has a range that is outside of the configured DNP3 mapping bounds for the specific group and variation.
DNP3 Request Too Many Objects	The PLX51-DNPS supports a maximum of 100 DNP3 objects in a single DNP3 request. These statistics indicates that more than 100 DNP3 objects were found in a single request.
DNP3 Message Queue Full	The PLX51-DNPS has received too many simultaneous messages to process.
Node Mismatch	The received message node number did not match the PLX51-DNPS configured node address.
Select Size Too Large	When the Select/Operate functionality is used the PLX51-DNPS supports a maximum of 255 bytes per transaction (or one full DNP3 message).
Select Operate Data Mismatch	The Select/Operate functionality requires that the response to the Select function matches the Select request.
Parity Error	The number of bytes with parity errors received by the module.

Table 10.3 – DNP3 Statistics

10.2.3 Logix Statistics

The following Logix statistics are only relevant when the module is communicating over EtherNet/IP.

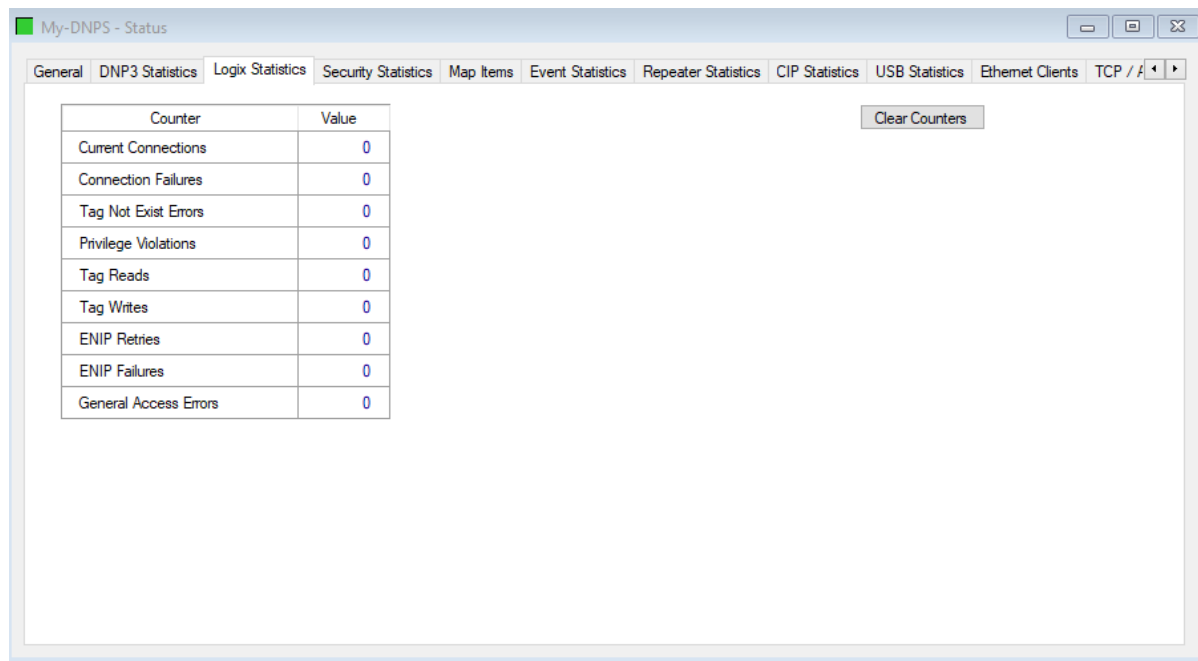

Figure 10.6 - Logix Statistics

Statistic	Description
Current Connections	The number of current open class 3 connections.
Connection Failures	The number of failed attempts at establishing a class 3 connections with a Logix controller.
Tag Not Exist Errors	The number of tag read and tag write transactions that failed due to the destination tag not existing.
Privilege Violation Errors	The number of tag read and tag write transactions that failed due to a privilege violation error. This may be caused by the External Access property of the Logix tag being set to either None or Read Only.
Tag Reads	The number of tag read transactions executed by the PLX51-DNPS module.
Tag Writes	The number of tag write transactions executed by the PLX51-DNPS module.
ENIP Retries	This count increases when no response was received from the Logix Controller by the time the ENIP timeout is reached.
ENIP Failures	This count increases when the ENIP Retry Limit is reached and no response has been received from the Logix Controller.
General Access Errors	This is the number of non-specific errors received from the Logix controller.

Table 10.4 – Logix Statistics

10.2.4 Modbus Statistics

The following Logix statistics are only relevant when the module is communicating over Modbus TCP/IP.

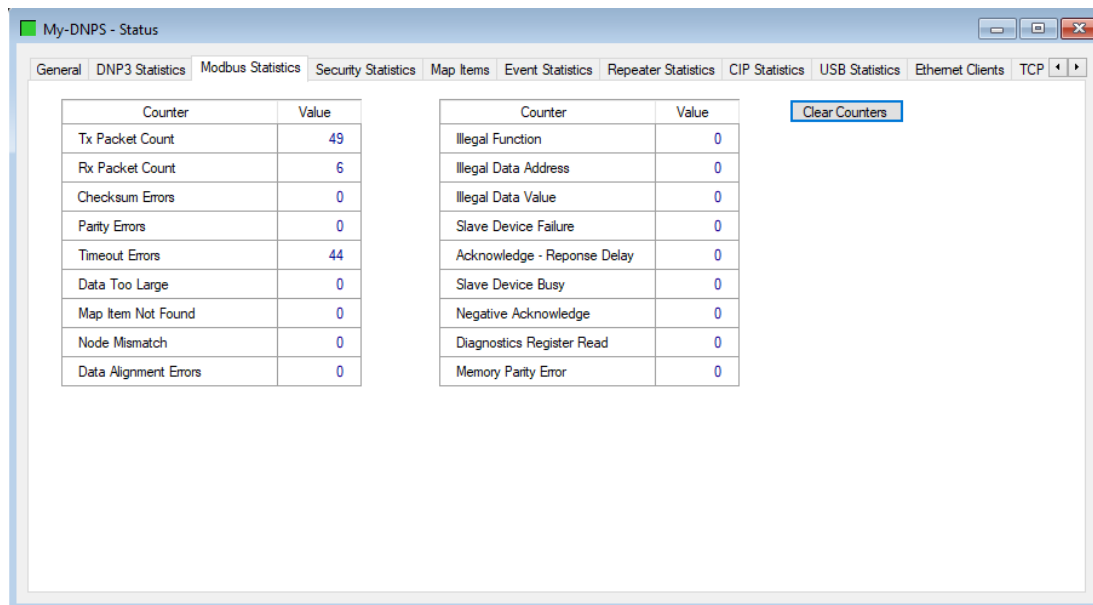

Figure 10.7 - Modbus Statistics

Statistic	Description
Tx Packet Count	The number of Modbus packets sent by the module.
Rx Packet Count	The number of Modbus packets received by the module.
Checksum Errors	The number of corrupted Modbus packets received by the module.
Parity Errors	The number of bytes with parity errors received by the module.
Timeout Errors	The number of message response timeouts the module has encountered.
Data Too Large	The number of Modbus requests/responses where the data was too large.
Map Item Not Found	The number of Modbus requests containing an invalid register.
Node Mismatch	The received Modbus request did not match the module's Modbus node address.
Data Alignment Errors	The Modbus request and associated mapped item is not byte aligned with the destination Logix tag.
Illegal Function	The number of Illegal Function exceptions returned by the Modbus device.
Illegal Data Address	The number of Illegal Data Address exceptions returned by the Modbus device.
Illegal Data Value	The number of Illegal Data Value exceptions returned by the Modbus device.
Slave Device Failure	The number of Device Failure exceptions returned by the Modbus device.
Acknowledge-Response Delay	The number of Acknowledge exceptions returned by the Modbus device.
Slave Device Busy	The number of Slave Busy exceptions returned by the Modbus device.
Negative Acknowledge	The number of Negative Acknowledge exceptions returned by the Modbus device.
Diagnostics Register Read	The number of times a Modbus Diagnostics request has been received. This is only relevant when the PLX51-DNPS is a Modbus Slave.
Memory Parity Error	The number of times a Modbus Slave has received a memory parity error indication. The memory parity error is when the slave attempts to read extended memory or record file, but detected a parity error in memory. This is only relevant when the PLX51-DNPS is Modbus Master.

Table 10.5 – Modbus Statistics

10.2.5 Security Statistics

The following Security statistics are only relevant when DNP3 Security has been enabled in the module configuration.

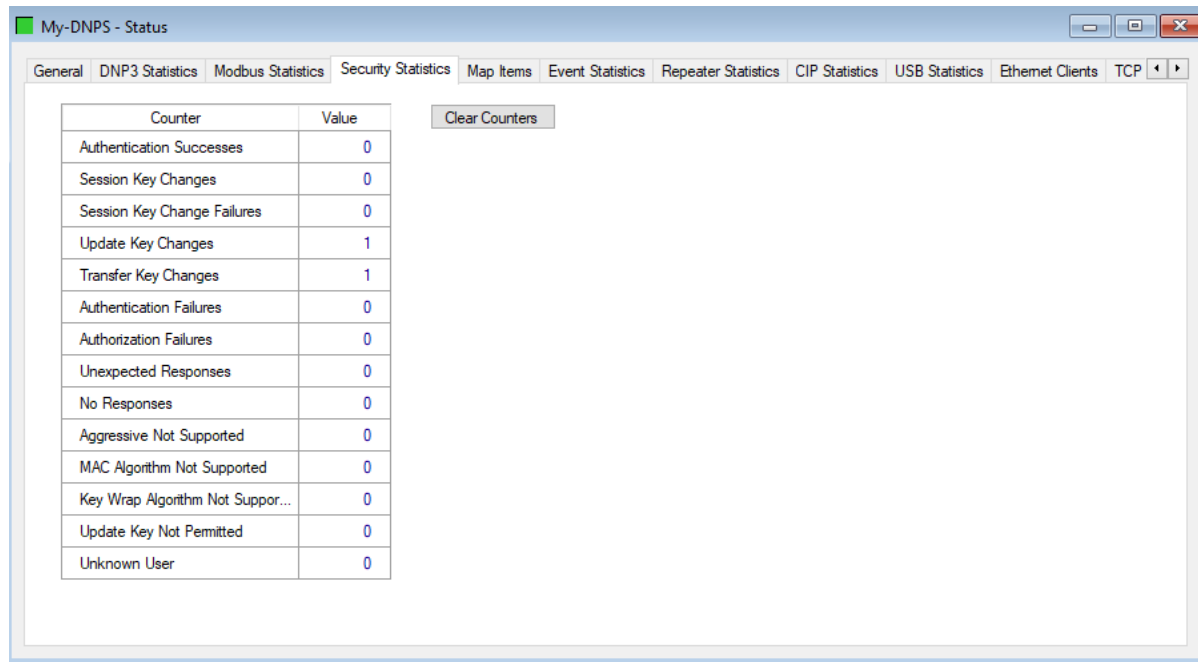

Figure 10.8 - Security Statistics

Statistic	Description
Authentication Successes	Increases every time the device successfully authenticates a message.
Session Key Changes	When the session keys have been successfully updated.
Session Key Change Failures	When the session keys have failed to update.
Update Key Changes	The Update Key has changed.
Transfer Key Changes	The Transfer Key has changed.
Authentication Failures	The other device has provided invalid authentication information such as an incorrect MAC.
Authorization Failures	Increases when a user is not authorized to perform a requested operation.
Unexpected Responses	The other device has responded with a message that was not expected during the authentication process.
No Responses	The other device has not replied during the authentication process.
Aggressive Not Supported	When Aggressive Mode Authentication is not supported this will increase.
MAC Algorithm Not Supported	The MAC algorithm requested is not supported
Key Wrap Algorithm Not Supported	The Key Wrap algorithm requested is not supported.
Update Key Not Permitted	Updating of a key was not permitted.
Unknown User	The user used for authentication was unknown. The default user (1) is the only user supported.

Table 10.6 - Security Statistics

10.2.6 Map Items

The *Map Items* tab will display the successful packet counts processed by each mapping item. If an item count changes, then the success count field will be displayed with a green background for approximately 3 seconds. This provides quick visual feedback as to which items are currently active. The fields will adjust to suite the appropriate mode.

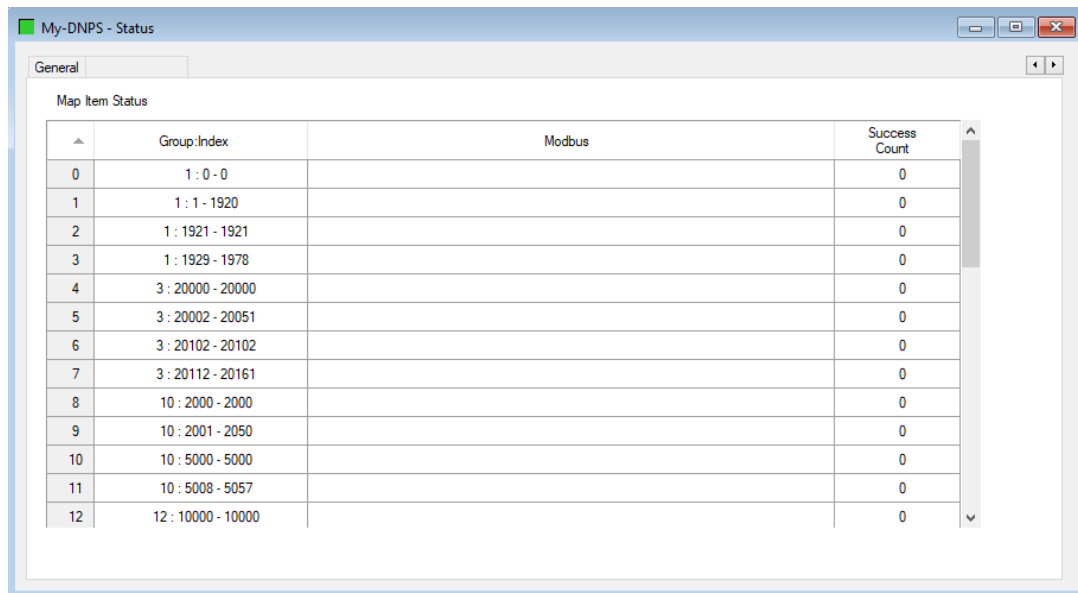

Figure 10.9 – Modbus TCP/IP Map Item status

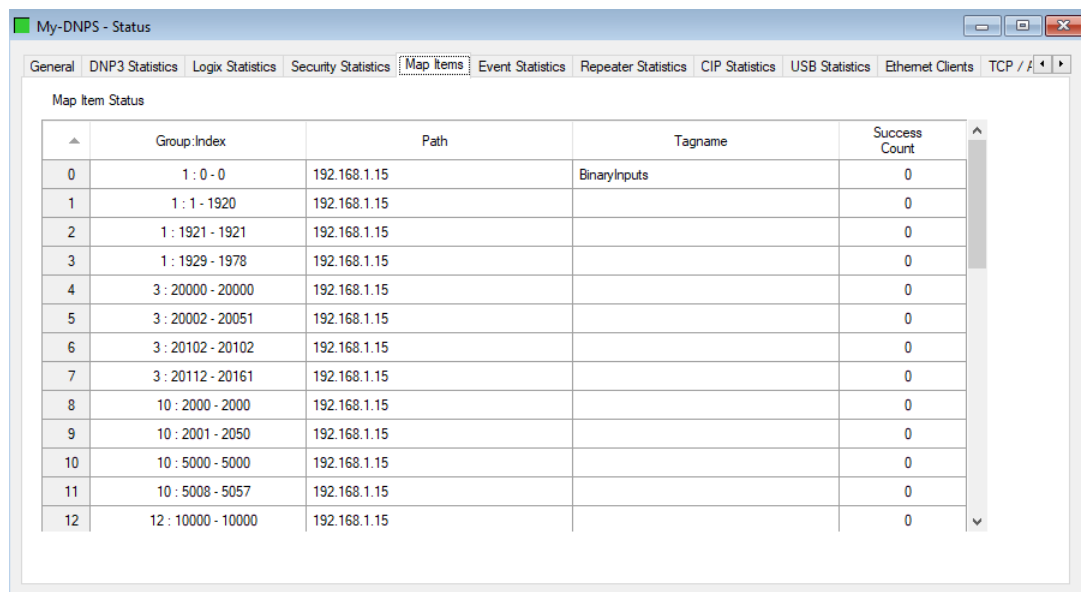

Figure 10.10 – EtherNet/IP Map Item status

Statistic	Description
Group:Index	The DNP3 Group and Object Index Range
Path	The CIP Path to the associated Controller (EtherNet/IP)
Tagname	The tagname (EtherNet/IP) or Modbus Register (Modbus) of the mapped item.
Success Count	The number of successful transactions associated with this mapped item.

Table 10.7 – Map Item status

10.2.7 Event Statistics

The event statistics will show how many events have been buffered for each class from each DNP event group. When Dual Master Event Unloading has been enabled, the event statistics will also show how many events have been buffered for each of the two DNP masters.

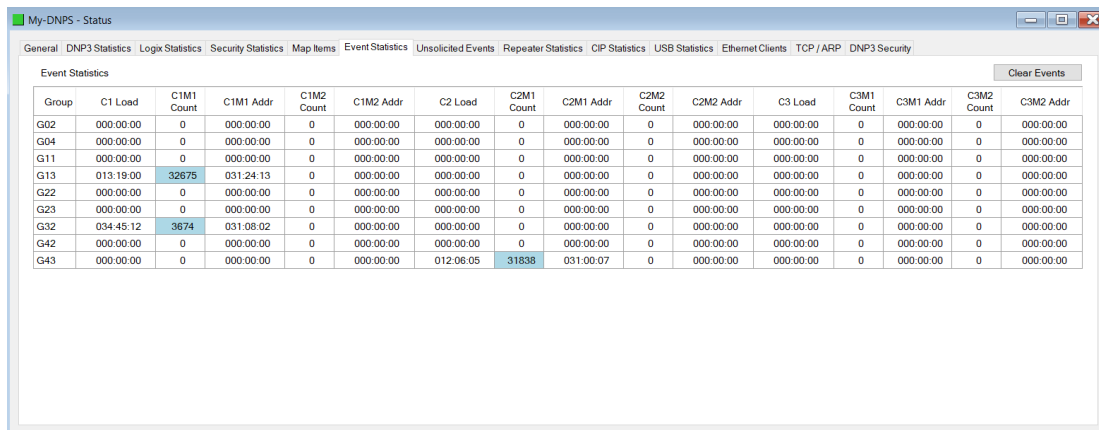

Figure 10.11 - Event Statistics

Statistic	Description
Group	The specific DNP3 Group used.
C1 Load	Memory address of event load index for class 1 events for the specific group.
C1M1 Count	The number of outstanding events for class 1 events for the specific group for Master 1.
C1M1 Addr	Memory address of event load index for class 1 events for the specific group for Master 1.
C1M2 Count	The number of outstanding events for class 1 events for the specific group for Master 2.
C1M2 Addr	Memory address of event load index for class 1 events for the specific group for Master 2.
C2 Load	Memory address of event load index for class 2 events for the specific group.
C2M1 Count	The number of outstanding events for class 2 events for the specific group for Master 1.
C2M1 Addr	Memory address of event load index for class 2 events for the specific group for Master 1.
C2M2 Count	The number of outstanding events for class 2 events for the specific group for Master 2.
C2M2 Addr	Memory address of event load index for class 2 events for the specific group for Master 2.
C3 Load	Memory address of event load index for class 3 events for the specific group.
C3M1 Count	The number of outstanding events for class 3 events for the specific group for Master 1.
C3M1 Addr	Memory address of event load index for class 3 events for the specific group for Master 1.
C3M2 Count	The number of outstanding events for class 3 events for the specific group for Master 2.
C3M2 Addr	Memory address of event load index for class 3 events for the specific group for Master 2.

Table 10.8 - Event Statistics

10.2.8 Unsolicited Events

The unsolicited events status will indicate the status for the unsolicited responses that have been unloaded, buffered, or are awaiting confirms.

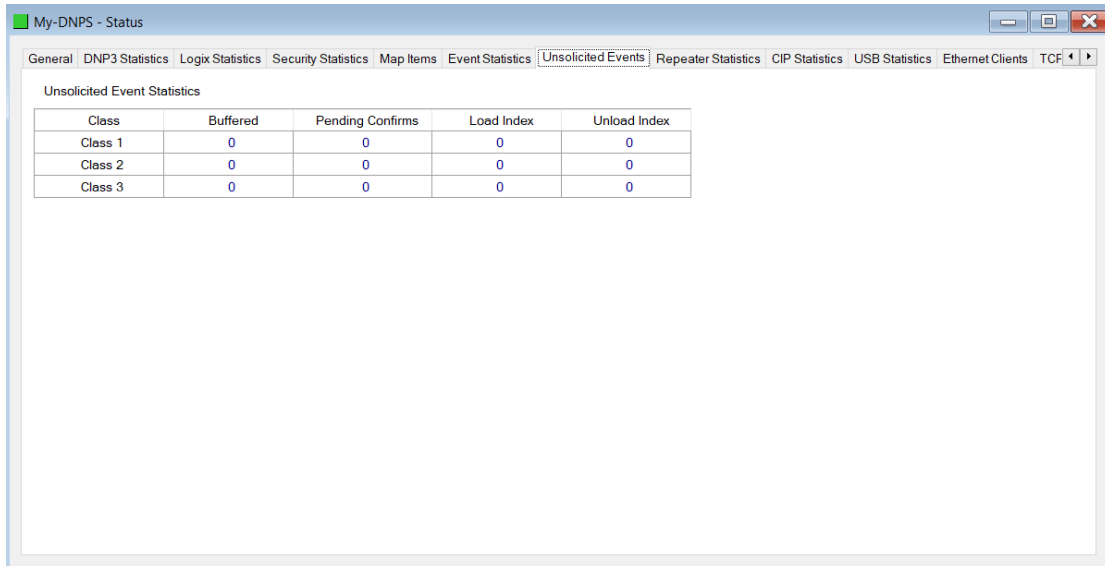

Figure 10.12 – Unsolicited Events

Statistic	Description
Buffered	The number of unsolicited responses that have been buffered to send.
Pending Confirms	The number of unsolicited responses that have been sent awaiting confirmation.
Load Index	The load index for unsolicited responses.
Unload Index	The unload index for unsolicited responses.

Table 10.9 - Unsolicited Events per Class

10.2.9 Repeater Statistics

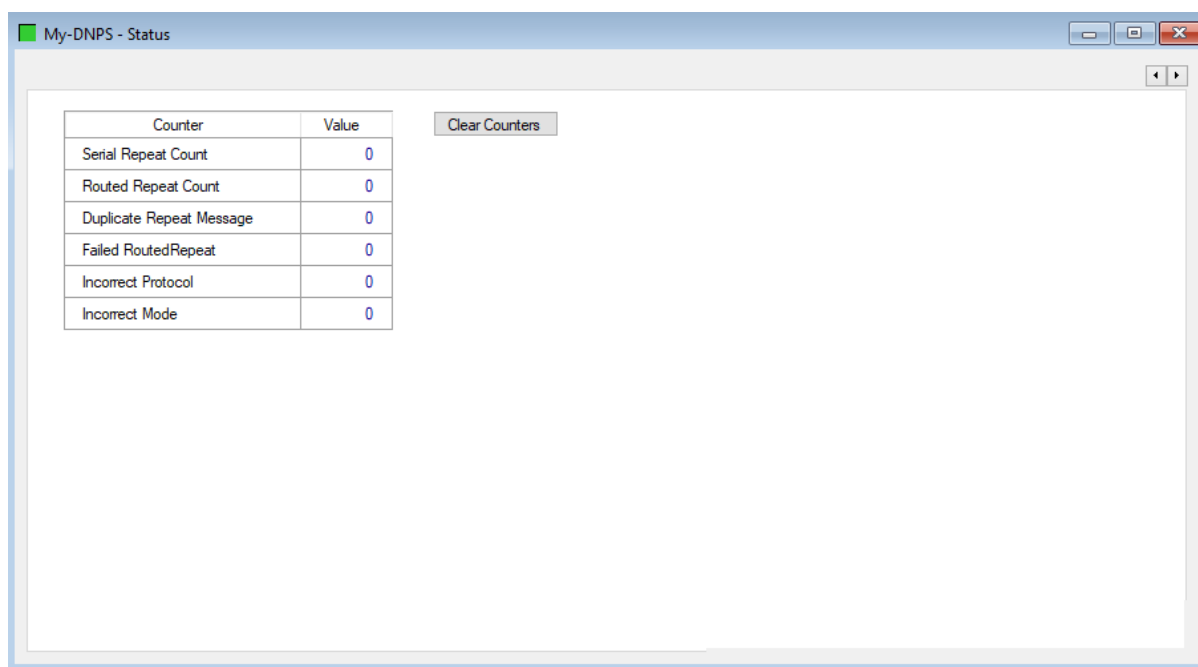

Figure 10.13 - Repeater Statistics

Statistic	Description
Serial Repeat Count	The number of messages that have been repeated on the serial network.
Routed Repeat Count	The number of messages that have been routed to another PLX51-DNPS on the Ethernet network.
Duplicate Repeat Message	The number of duplicate repeat messages that have been received. Note that with multi-hop architectures this number will increase during normal operation.
Failed Routed Repeat	The number of times a routed message was sent to a PLX51-DNPS that returned an error code.
Incorrect Protocol	The number of times a routed message is received by the PLX51-DNPS which has not been configured for Serial Communication.
Incorrect Mode	The number of times a routed message is received by the PLX51-DNPS which has is not in Outstation Operating Mode.

Table 10.10 - Repeater Statistics

10.2.10 CIP Statistics

Each PLX51-DNPS provides a set of Common Industrial Protocol (CIP) communication statistics as shown below:

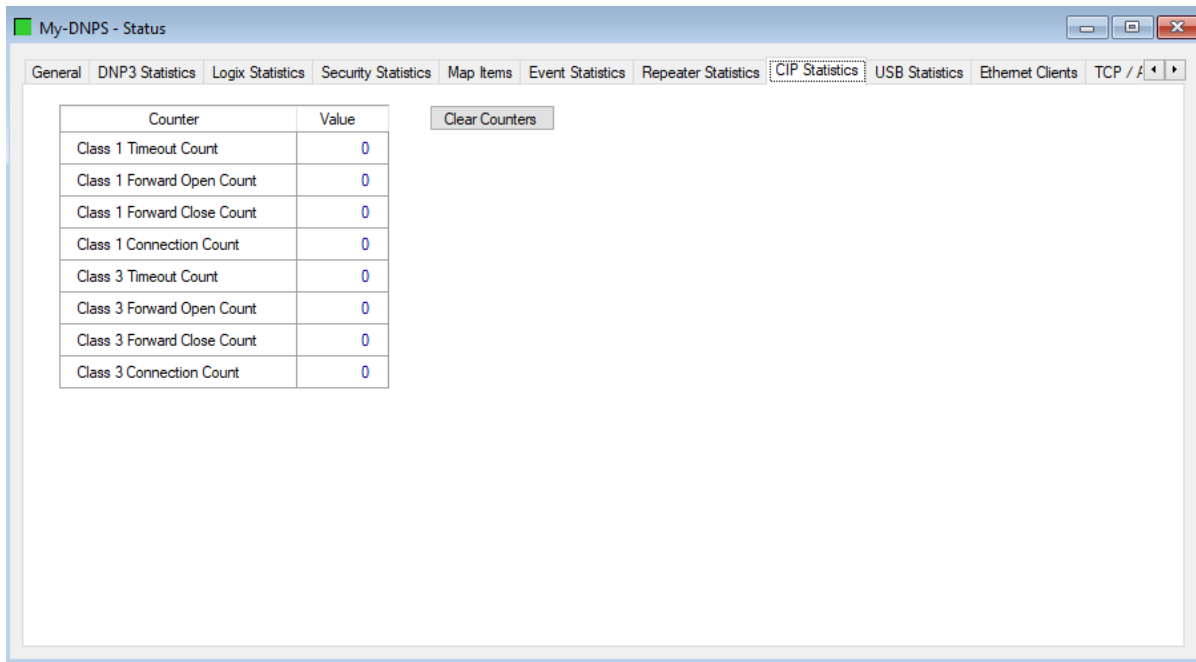

Figure 10.14 - CIP Statistics

Statistic	Description
Class 1 Timeout Count	Number of times a Class 1 connection has timed out.
Class 1 Forward Open Count	Number of Class 1 Connection establish attempts.
Class 1 Forward Close Count	Number of Class 1 Connection close attempts.
Class 1 Connection Count	Number of Class 1 Connections currently active.
Class 3 Timeout Count	Number of times a Class 3 connection has timed out.
Class 3 Forward Open Count	Number of Class 3 Connection establish attempts.
Class 3 Forward Close Count	Number of Class 3 Connection close attempts.
Class 3 Connection Count	Number of Class 3 Connections currently active.

Table 10.11 - CIP Statistics

10.2.11 USB Statistics

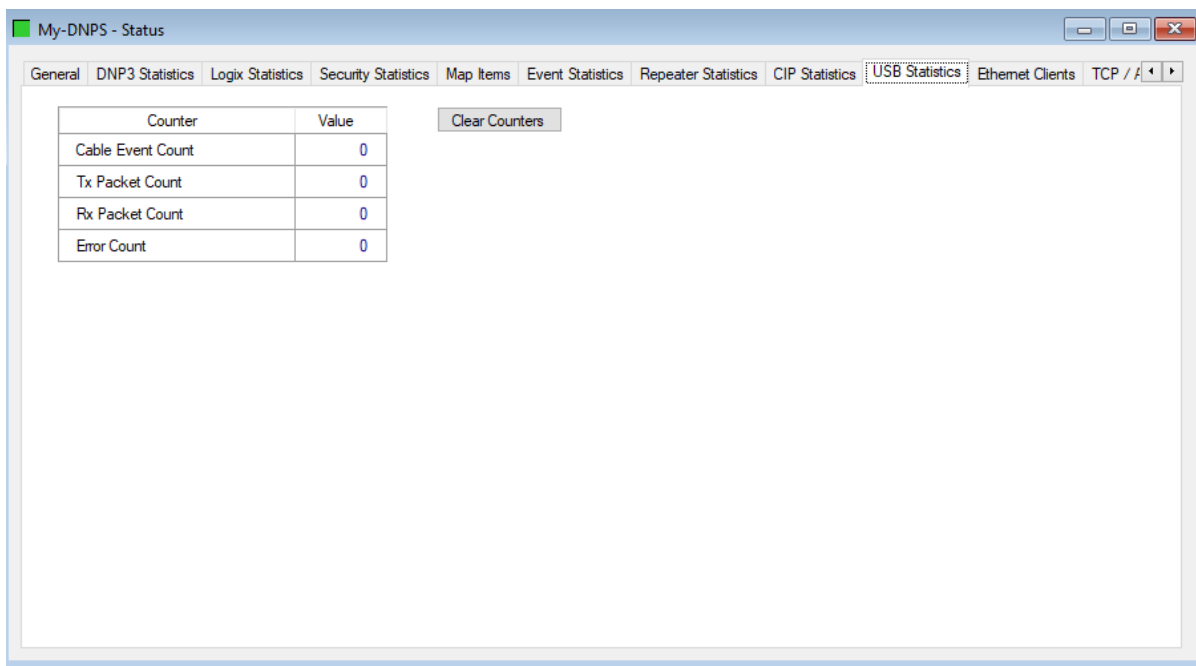

Figure 10.15 - USB Statistics

Statistic	Description
Cable Event Count	This is the number of times the USB cable has either been removed or inserted from the Host or Client.
Tx Packet Count	The number of packets sent on the USB port.
Rx Packet Count	The number of packets received on the USB port.
Error Count	The number of errors that have occurred on the USB port. You will need to open the module event log for more detail regarding the error.

Table 10.12 - USB Statistics

10.2.12 Ethernet Clients

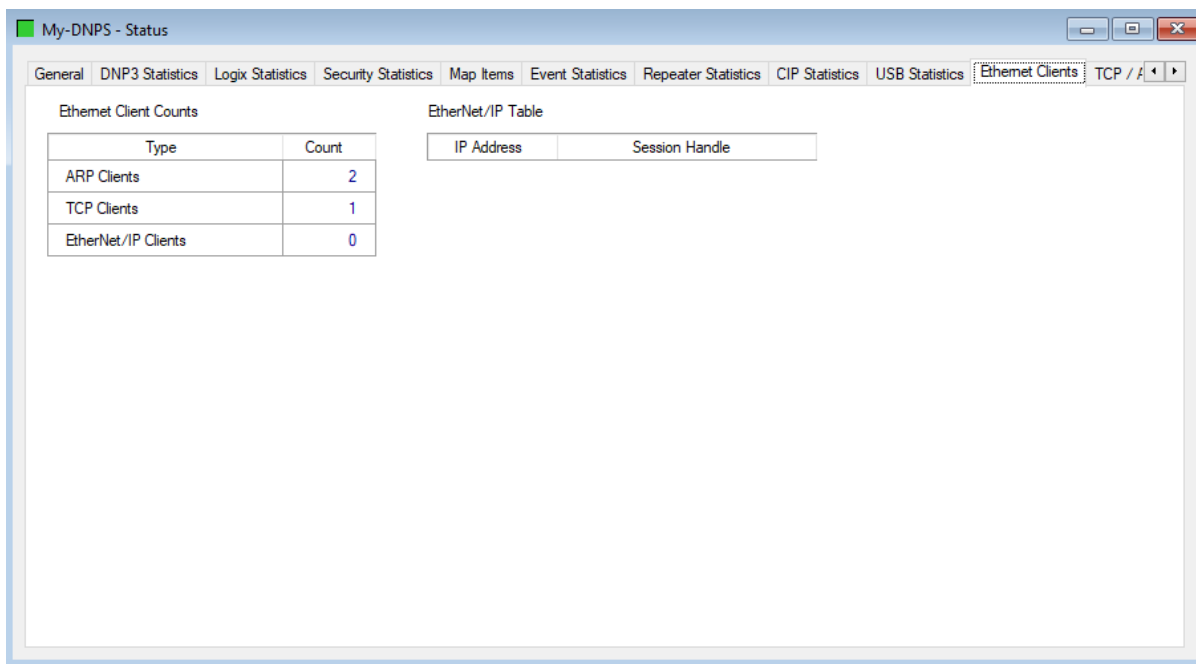

Figure 10.16 - Ethernet Clients

Statistic	Description
<i>Ethernet Clients</i>	
ARP Clients	The number of ARP (Address Resolution Protocol) Clients
TCP Clients	The number of TCP (Transmission Control Protocol) Clients
EtherNet/IP Clients	The number of EtherNet/IP Clients
<i>EtherNet/IP Table</i>	
IP Address	IP Address of the remote EtherNet/IP client
Session Handle	Session Handle associated with the EtherNet/IP connection

Table 10.13 – Ethernet Clients

10.2.13 TCP / ARP Tables

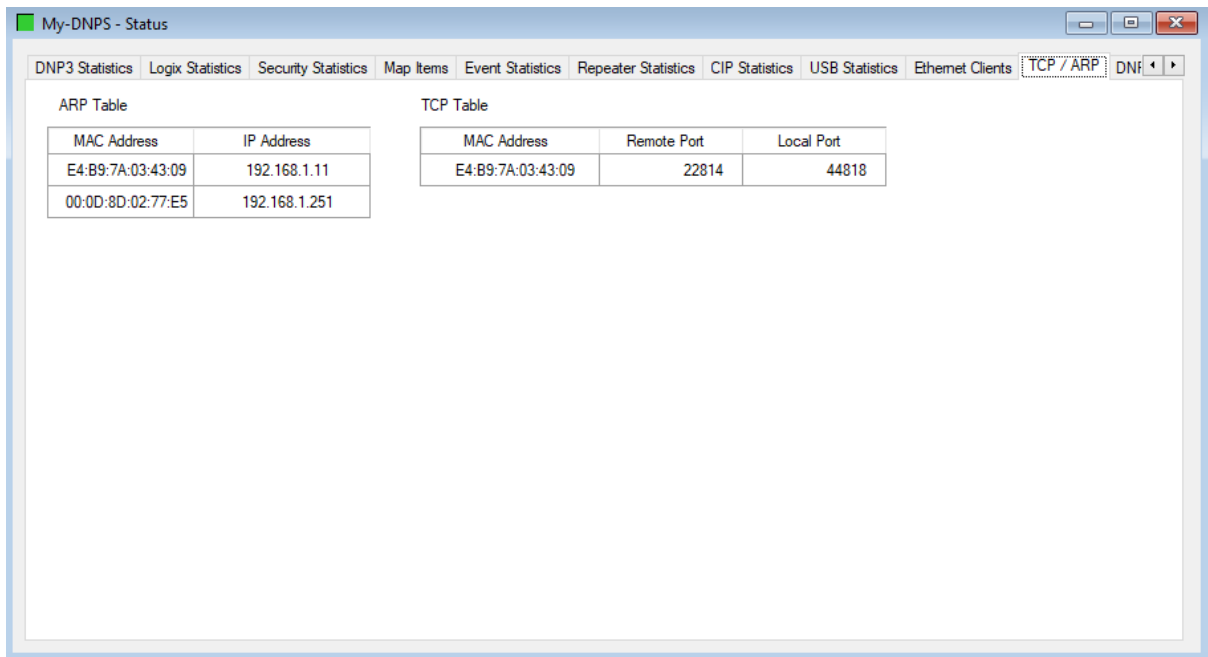

Figure 10.17 - TCP / ARP tables

Statistic	Description
<i>ARP (Address Resolution Protocol) Table</i>	
MAC Address	The MAC address of the remote Ethernet interface.
IP Address	The IP (Internet Protocol) address.
<i>TCP (Transmission Control Protocol) Table</i>	
MAC Address	The MAC address of the remote Ethernet interface.
Remote Port	The TCP Port of the remote device.
Local Port	The TCP port of the local device.

Table 10.14 – TCP / ARP tables

10.3 DNP3 Packet Capture

The PLX51-DNPS module provides the capability to capture the DNP3 traffic for analysis. This will assist you and the support team to diagnose any possible issues. To invoke the capture of the module, double-click on the DNP3 Packet Capture item in the Project Explorer tree.

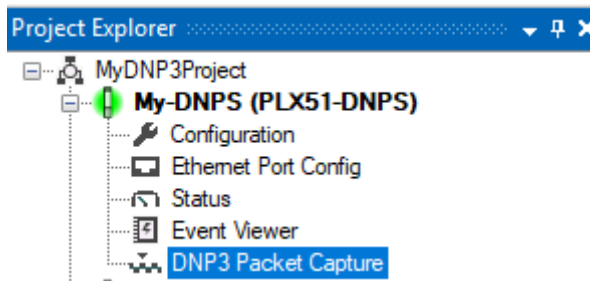

Figure 10.18 - Selecting DNP3 Packet Capture

The DNP3 Packet Capture window will open and automatically start capturing all DNP3 packets.

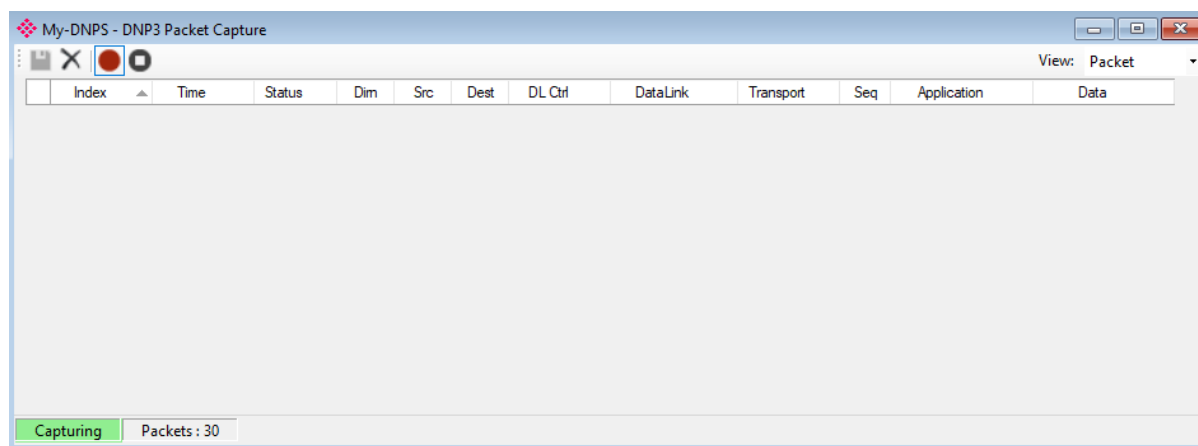

Figure 10.19 – DNP3 Packet Capture

To display the captured DNP3 packets, the capture process must first be stopped, by pressing the **Stop** button.

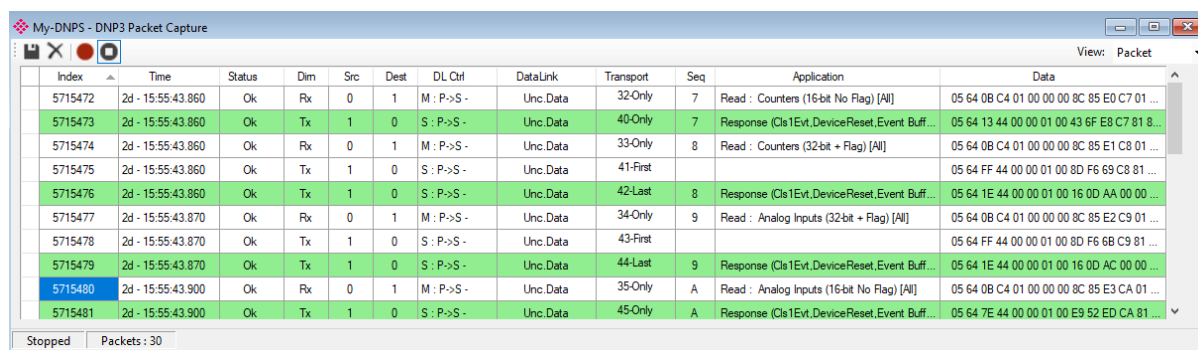

Figure 10.20 – DNP3 Packet Capture complete

The captured DNP3 packets are tabulated as follows:

Statistic	Description
Index	The packet index, incremented for each packet sent or received.
Time	The elapsed time since the module powered up.
Status	The status of the packet. Received packets are checked for valid DNP3 constructs and valid checksums.
Dirn	The direction of the packet, either transmitted (Tx) or received (Rx).
Src	DNP3 node address of the message source.
Dest	DNP3 node address of the message destination.
DL Ctrl	Data Link layer control. Part 1 : M – Master / S – Slave Part 2 : P->S : Primary to Secondary / S->P : Secondary to Primary Part 3 : Frame Count - : FCV = 0 (Frame count ignored) 0 : FCV = 1, FCB = 0 (Frame Count = 0) 1 : FCV = 1, FCB = 1 (Frame Count = 1)
Data Link	Data Link function.
Transport	Transport sequence numbers.
Seq	Application sequence numbers
Application	Application Layer

Table 10.15 – DNP3 Packet Capture fields

The packet capture can be saved to a file for further analysis, by selecting the **Save** button on the toolbar. Previously saved DNP3 Packet Capture files can be viewed by selecting the DNP3 **Packet Capture Viewer** option in the **Tools** menu.

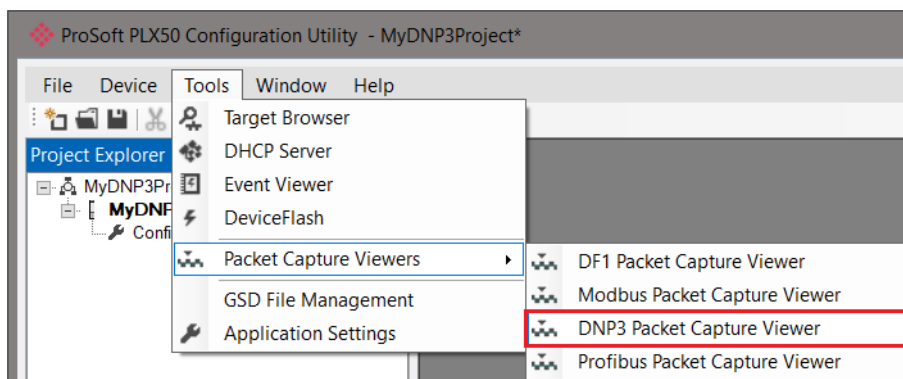

Figure 10.21 - Selecting the DNP3 Packet Capture Viewer

10.4 Module Event Log

The PLX51-DNPS module logs various diagnostic records to an internal event log. These logs are stored in non-volatile memory and can be displayed using the PLX50 Configuration Utility or via the web interface.

To view them in PLX50 Configuration Utility, select the **Event Viewer** option in the Project Explorer tree.

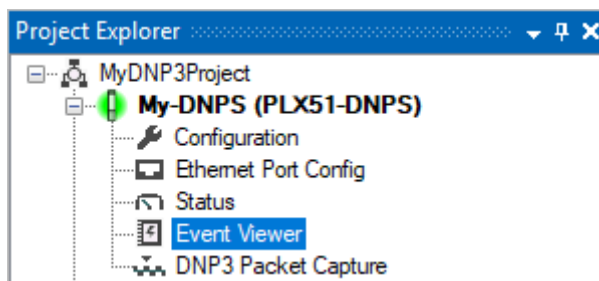

Figure 10.22 - Selecting the Module Event Log

The Event Log window will open and automatically read all the events from the module.

The log entries are sorted so as to have the latest record at the top. Custom sorting is achieved by double-clicking on the column headings.

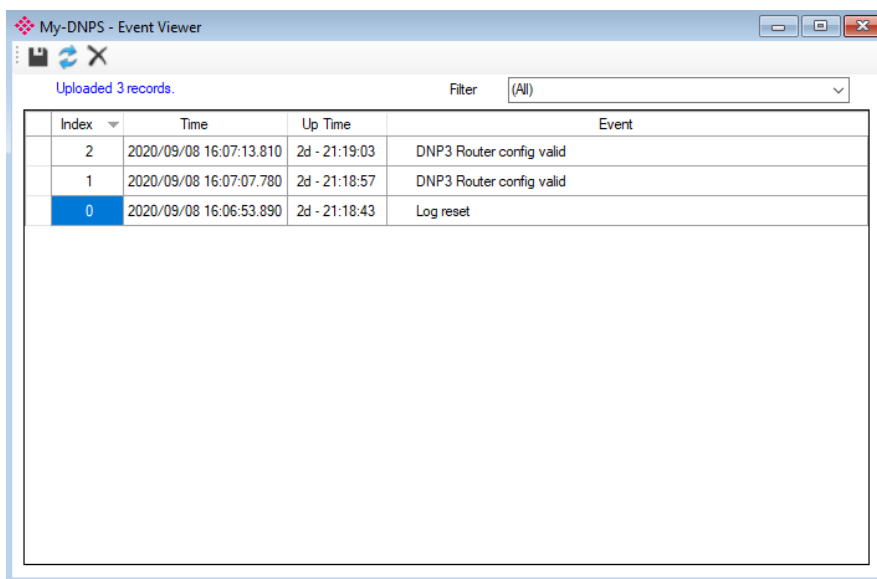

Figure 10.23 – Module Event Log

The log can also be stored to a file for future analysis, by selecting the **Save** button in the tool menu.

To view previously saved files, use the **Event Log Viewer** option under the **Tools** menu.

10.5 Web Server

The PLX51-DNPS module hosts a web server allowing a user without PLX50 Configuration Utility or RSLogix 5000 to view various diagnostics of the module. This includes Ethernet parameters, the system event log, advanced diagnostics, and application diagnostics (DNP3 diagnostics).

NOTE: The web server is read-only and thus no parameters or configuration can be altered from the web interface.

Module: PLX51-DNPS Serial: 8DF0DDE9 Firmware Rev: 1.003.008		ProSoft TECHNOLOGY
Overview	Device Name	PLX51-DNPS
Ethernet	Serial number	8DF0DDE9
Event Logs	Firmware Revision	1.003.008
Diagnostics	Vendor Id	309
Application	Product Type	12
	Product Code	5213
	Uptime	2d 21h 20m 5s
	Date	2020/09/08
	Time	16:08:15
	Temperature	61.7640°C
	Hardware MAC	00:60:35:2D:FD:6A
	System MAC	00:0D:8D:F0:DD:E9
	Switches at Startup	0:0:0
	Switches Now	0:0:0
	Ethernet Port 1	Link down Port Mirror Disabled
	Ethernet Port 2	Link Up Port Mirror Disabled
	SD Card Status	No SD Card
	Ethernet Status	Ok
	Bootloader	PLX51-DNPS (BOOT) Rev 1.3
	Owned	Not Owned
	DLR Status	Disabled

Copyright 2019 ProSoft. All rights reserved.

Figure 10.24 - Web interface

11 Technical Specifications

11.1 Dimensions

Below are the enclosure dimensions as well as the required DIN rail dimensions. All dimensions are in millimeters.

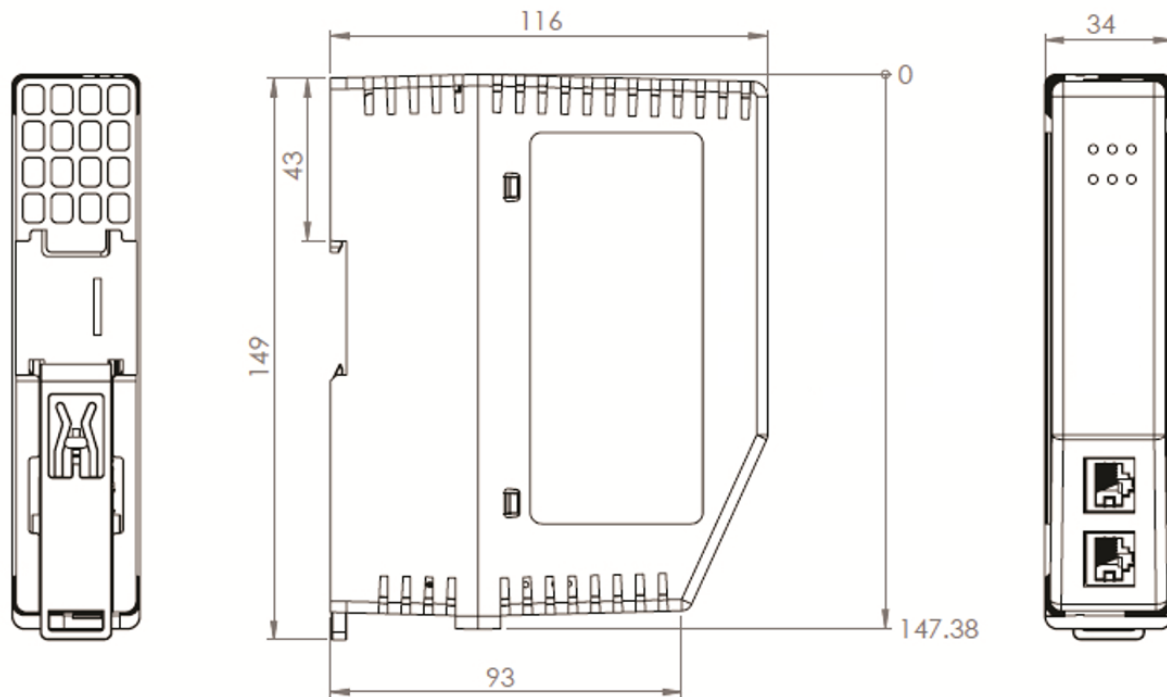

Figure 11.1 – DNP module enclosure dimensions

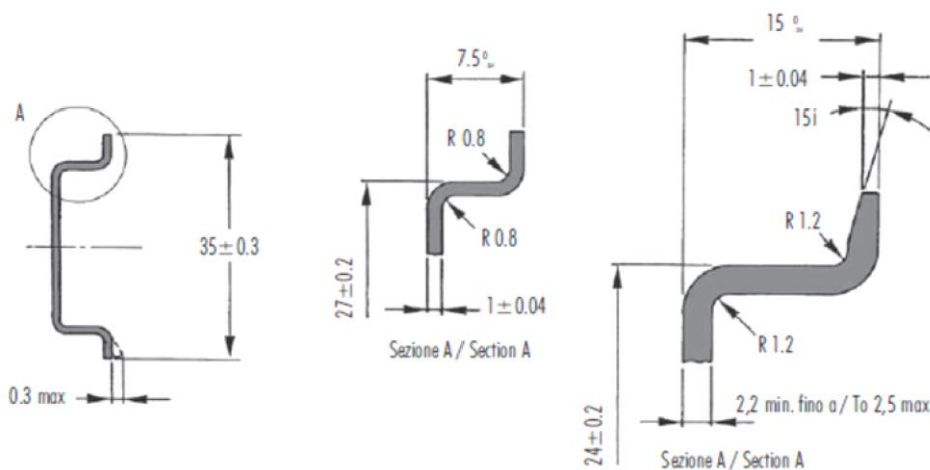

Figure 11.2 - Required DIN dimensions

11.2 Electrical

Specification	Rating
Power requirements	Input: 10 to 32V DC, (121 mA @ 24 VDC)
Voltage Fluctuations	Voltage fluctuations < ±10% Transient Over-voltages up to the levels of OVERVOLTAGE CATEGORY I
Power consumption	3.1 W (Including full load on USB of 200mA) 300 mA maximum
USB Power	5V, maximum load of 200 mA (1W).
Connector	3-way terminal
Conductors	24 – 18 AWG
Earth connection	Yes, terminal based
Emissions	IEC61000-6-4
ESD Immunity	EN 61000-4-2
Radiated RF Immunity	IEC 61000-4-3
EFT/B Immunity	EFT: IEC 61000-4-4
Surge Immunity	Surge: IEC 61000-4-5
Conducted RF Immunity	IEC 61000-4-6

Table 11.1 - Electrical specification

11.3 Environmental

Specification	Rating
Enclosure rating	IP20, NEMA/UL Open Type Indoor use only
Temperature	-20 to 70 °C
Relative Humidity	5% to 90% - No condensation
Pollution Degree	2
Altitude	< 2000 m

Table 11.2 - Environmental specification

11.4 Ethernet

Specification	Rating
Connector	RJ45
Conductors	CAT5 STP/UTP
ARP connections	Max 40
TCP connections	Max 40
CIP connections	Max 10
Communication rate	10/100Mbps
Duplex mode	Full/Half
Auto-MDIX support	Yes
Embedded switch	Yes, 2 x Ethernet ports

Table 11.3 - Ethernet specification

11.5 Serial Port (RS232)

Specification	Rating
RS232 Connector	9-way terminal (shared with RS485)
RS232 Conductor	24 – 18 AWG
Electrical Isolation	1000 Vdc
BAUD	1200, 2400, 4800, 9600, 19200, 38400, 57600, 115200
Parity	None, Even, Odd
Data bits	8
Stop bits	1

Table 11.4 – RS232 Serial Port specification

11.6 Serial Port (RS485)

Specification	Rating
RS485 Connector	9-way terminal (shared with RS485)
RS485 Conductor	24 – 18 AWG
Electrical Isolation	1500 Vrms for 1 minute.
BAUD	1200, 2400, 4800, 9600, 19200, 38400, 57600, 115200
Parity	None, Even, Odd
Data bits	8
Stop bits	1

Table 11.5 – RS485 Serial Port specification

11.7 USB Port

Specification	Rating
USB supported	USB2.0 NOTE: The USB interface can only be used with Logix Controllers that have a USB port. The module cannot route (via USB) across the backplane from another module (e.g. EN2T) to a Logix controller.
Module USB Connector	Type-A
Recommended USB Cable	Type-A (male) to Type-B (male)

Table 11.6 – USB Port specification

11.8 DNP3

Specification	Rating
Outstation mode	Max 1000 mapping items
Master mode	Max 1000 mapping items
Concentrator mode	Max 1000 mapping items
Application Functions Supported	Read Write Select/Operate Direct-Operate Direct-Operate-No-Response Confirm (only in Outstation Mode) Immediate Freeze (only in Outstation Mode) Immediate Freeze No Response (only in Outstation Mode) Immediate Freeze and Clear (only in Outstation Mode) Immediate Freeze and Clear No Response (only in Outstation Mode) Cold Restart (only in Outstation Mode) Enable / Disable Unsolicited Messages (only in Outstation Mode) Delay Measure (only in Outstation Mode) Record Current Time (only in Outstation Mode) Unsolicited Response (only in Outstation Mode) Authentication Request Authentication Response Assign Classes
Maximum DNP3 objects per request	30
Maximum DNP3 request size per mapped item in Outstation Tag Mode	1000 bytes
Maximum DNP3 request size per mapped item in Master Tag Mode	230 bytes
Maximum Logix Controller support	3
Unsolicited Response support	Yes
Maximum event buffer per DNP3 group class	50,000 (total of 1,350,000)
Number of Commands per Request	1
Event Read Interval	10ms

Table 11.7 – DNP3 specification

11.9 DNP3 Secure Authentication

Specification	Rating
Key Change Method Supported	Pre-shared
MAC Algorithms Supported	HMAC SHA-1 encryption (4 octets – serial) – for legacy support HMAC SHA-1 encryption (8 octets – serial) HMAC SHA-1 encryption (10 octets – networked) HMAC SHA-256 encryption (8 octets – serial) HMAC SHA-256 encryption (16 octets – networked) AES-GMAC (12 octets)
Key Wrap Algorithms Supported	AES-128 Key Wrap AES-256 Key Wrap
Aggressive Mode Supported	Yes

Table 11.8 – DNP3 Secure Authentication specification

12 Appendix A - DNP3 Reference

12.1 DNP3 Functions

Code	Function
00	Confirm
01	Read
02	Write
03	Select
04	Operate
05	Direct Operate
06	Direct Operate - No Response
07	Freeze
08	Freeze - No Response
09	Freeze Clear
0a	Freeze Clear - No Response
0b	Freeze At Time
0c	Freeze At Time - No Response
0d	Cold Restart
0e	Warm Restart
0f	Initialize Data
10	Initialize Application
11	Start Application
12	Stop Application
13	Save Configuration
14	Enable Unsolicited
15	Disable Unsolicited
16	Assign Class
17	Delay Measurement
18	Record Current Time
19	Open File
1a	Close File
1b	Delete File
1c	Get File Information
1d	Authenticate File
1e	Abort File
1f	Activate Config
20	Authenticate Request
21	Authenticate Request - No Ack
81	Response
82	Unsolicited Response
83	Authentication Response

DNP3 Functions

12.2 DNP3 Groups

Group	Description
0	Device Attributes
1	Binary Inputs
2	Binary Input Events
3	Double Bit Binary Inputs
4	Double Bit Binary Input Events
10	Binary Outputs (Status)
11	Binary Output Events
12	Binary Output Commands
13	Binary Output Command Events
20	Counters
21	Frozen Counters
22	Counter Events
23	Frozen Counter Events
30	Analog Inputs
31	Frozen Analog Inputs
32	Analog Input Events
33	Frozen Analog Input Events
34	Analog Input Reporting Deadbands
40	Analog Output Status
41	Analog Outputs (Commands)
42	Analog Output Events
43	Analog Output Command Events
50	Time And Date
51	Time And Date Of Occurrence
52	Time Delays
60	Class Objects
70	File Control
80	Internal Indications
81	Device Storage
82	Device Profiles
83	Data Sets
85	Data Set Prototypes
86	Data Set Descriptors
87	Data Sets Present Value
88	Data Set Events
90	Applications
91	Status Of Requested Operations
100	Floating Point
101	BCD Integers
102	Unsigned Integers
110	Octet Strings
111	Octet String Events
112	Virtual Terminal Output Blocks
113	Virtual Terminal Event Data

120	Authentication
121	Security Statistics
122	Security Statistic Events

DNP3 Groups

12.3 Supported DNP3 Group Variations

Group	Group Description	Supported Functions	Var. Code	Var. Desc.	Recommended Data Type	Supports Events
1	Binary Inputs	Read	1	Packed Format	SINT	
			2	With Flags	ProSoft TechnologyDNP3BinaryInputWithFlag	•
3	Double Bit Binary Inputs	Read	1	Packed Format	SINT	
			2	With Flags	ProSoft TechnologyDNP3DoubleBinaryInputWithFlag	•
10	Binary Outputs	Read	1	Packed Format	SINT	
			2	Output Status With Flags	ProSoft TechnologyDNP3BinaryOutputWithFlag	•
12	Binary Output Commands	Operate*	1	Control Relay Output Block	ProSoft TechnologyDNP3CROB	•
20	Counters	Read Freeze Clear	1	32-bit With Flag	ProSoft TechnologyDNP3Counter32WithFlag	•
			2	16-bit With Flag	ProSoft TechnologyDNP3Counter16WithFlag	•
			5	32-bit Without Flag	DINT	
			6	16-bit Without Flag	INT	
21	Frozen Counters	Read	1	32-bit With Flag	ProSoft TechnologyDNP3Counter32WithFlag	•
			2	16-bit With Flag	ProSoft TechnologyDNP3Counter16WithFlag	•
			5	32-bit With Flag And Time	ProSoft TechnologyDNP3Counter32WithFlagTime	•
			6	16-bit With Flag And Time	ProSoft TechnologyDNP3Counter16WithFlagTime	•
			9	32-bit Without Flag	DINT	
			10	16-bit Without Flag	INT	
30	Analog Inputs	Read	1	32-bit With Flag	ProSoft TechnologyDNP3AnalogInput32Flag	•

			2	16-bit With Flag	ProSoft TechnologyDNP3AnalogInput16Flag	•
			3	32-bit Without Flag	DINT	
			4	16-bit Without Flag	INT	
			5	Single Floating Point With Flag	ProSoft TechnologyDNP3AnalogInputRealFlag	•
40	Analog Output Status	Read	1	32-bit With Flag	ProSoft TechnologyDNP3AnalogOutput32Flag	•
			2	16-bit With Flag	ProSoft TechnologyDNP3AnalogOutput16Flag	•
			3	Single Floating Point With Flag	ProSoft TechnologyDNP3AnalogOutputRealFlag	•
41	Analog Outputs	Operate*	1	32-bit	ProSoft TechnologyDNP3AnalogOutput32	•
			2	16-bit	ProSoft TechnologyDNP3AnalogOutput16	•
			3	Single Floating Point	ProSoft TechnologyDNP3AnalogOutputReal	•
102	Unsigned Integers	Read Write	1	8-bit	SINT	

Supported DNP3 Group Variations

Note: The Operate function refers to all the Operate functions: Select, Operate, Direct Operate and Direct Operate without Acknowledge.

12.4 DNP3 Qualifier Code

The qualifier code (byte) is made up of the Object Prefix nibble and the Range Field nibble as described in the table below.

Bit Number -->

7	6	5	4	3	2	1	0
Prefix Code				Range Specifier Code			

DNP3 qualifier code

Prefix Code	Object Prefix
0	Objects packed without a prefix
1	Objects prefixed with 8-bit index
2	Objects prefixed with 16-bit index
3	Objects prefixed with 32-bit index
4	Objects prefixed with 8-bit size
5	Objects prefixed with 16-bit size
6	Objects prefixed with 32-bit size
7	Reserved

DNP3 object prefix code

Range Code	Range Specifier
0	8-bit Start-Stop index
1	16-bit Start-Stop index
2	32-bit Start-Stop index
3	8-bit Start-Stop virtual address
4	16-bit Start-Stop virtual address
5	32-bit Start-Stop virtual address
6	No range - implies All
7	8-bit Count of objects
8	16-bit Count of objects
9	32-bit Count of objects
A	Reserved
B	8-bit Count of objects, variable format
C	Reserved
D	Reserved
E	Reserved
F	Reserved

DNP3 Range Field specifier code

Qualifier Code	Object Prefix	Range Specifier	Preferred
00	Objects packed without a prefix	8-bit Start-Stop index	•
01	Objects packed without a prefix	16-bit Start-Stop index	•
02	Objects packed without a prefix	32-bit Start-Stop index	
03	Objects packed without a prefix	8-bit Start-Stop virtual address	
04	Objects packed without a prefix	16-bit Start-Stop virtual address	
05	Objects packed without a prefix	32-bit Start-Stop virtual address	
06	Objects packed without a prefix	No range - implies All	•
07	Objects packed without a prefix	8-bit Count of objects	•
08	Objects packed without a prefix	16-bit Count of objects	•
09	Objects packed without a prefix	32-bit Count of objects	
17	Objects prefixed with 8-bit index	8-bit Count of objects	•
18	Objects prefixed with 8-bit index	16-bit Count of objects	
19	Objects prefixed with 8-bit index	32-bit Count of objects	
27	Objects prefixed with 16-bit index	8-bit Count of objects	
28	Objects prefixed with 16-bit index	16-bit Count of objects	•
29	Objects prefixed with 16-bit index	32-bit Count of objects	
37	Objects prefixed with 32-bit index	8-bit Count of objects	
38	Objects prefixed with 32-bit index	16-bit Count of objects	
39	Objects prefixed with 32-bit index	32-bit Count of objects	
4B	Objects prefixed with 8-bit size	8-bit Count of objects, variable format	
5B	Objects prefixed with 16-bit size	8-bit Count of objects, variable format	•
6B	Objects prefixed with 32-bit size	8-bit Count of objects, variable format	

DNP3 valid qualifier range codes

12.5 DNP3 Event Status Flags

Group	Flag Description
2 – Binary Input Events	Bit 0 – Online Bit 1 – Restart Bit 2 – Communication Lost Bit 3 – Remote Forced Bit 4 – Local Forced Bit 5 – Chatter Filter Bit 6 – Reserved Bit 7 – Input State
4 – Double-bit Binary Input Events	Bit 0 – Online Bit 1 – Restart Bit 2 – Communication Lost Bit 3 – Remote Forced Bit 4 – Local Forced Bit 5 – Chatter Filter Bit 6 – Input State 0 Bit 7 – Input State 1
11 – Binary Output Events	Bit 0 – Online Bit 1 – Restart Bit 2 – Communication Lost Bit 3 – Remote Forced Bit 4 – Local Forced Bit 5 – Reserved Bit 6 – Reserved Bit 7 – Output State
13 – Binary Output Command Events	Bit 0 → 6 <ul style="list-style-type: none"> ▪ 0 – Success ▪ 1 – Timeout ▪ 2 – No Select ▪ 3 – Format Error ▪ 4 – Not Supported ▪ 5 – Already Active Bit 7 – Commanded State
22 – Counter Events	Bit 0 – Online Bit 1 – Restart Bit 2 – Communication Lost Bit 3 – Remote Forced Bit 4 – Local Forced Bit 5 – Rollover Bit 6 – Discontinuity Bit 7 – Reserved
23 – Frozen Counter Events	Bit 0 – Online Bit 1 – Restart Bit 2 – Communication Lost Bit 3 – Remote Forced Bit 4 – Local Forced Bit 5 – Rollover Bit 6 – Discontinuity Bit 7 – Reserved
32 – Analog Input Events	Bit 0 – Online Bit 1 – Restart Bit 2 – Communication Lost Bit 3 – Remote Forced

	Bit 4 – Local Forced Bit 5 – Over range Bit 6 – Reference Error Bit 7 – Reserved
42 – Analog Output Events	Bit 0 – Online Bit 1 – Restart Bit 2 – Communication Lost Bit 3 – Remote Forced Bit 4 – Local Forced Bit 5 – Over range Bit 6 – Reference Error Bit 7 – Reserved
43 – Analog Output Command Events	Bit 0 → 6 <ul style="list-style-type: none"> ▪ 0 – Success ▪ 1 – Timeout ▪ 2 – No Select ▪ 3 – Format Error ▪ 4 – Not Supported ▪ 5 – Already Active Bit 7 – Reserved

DNP3 event group status flags

12.6 DNP3 Control Relay Output Block (CROB)

Below is the format of the CROB request data:

Byte	Parameter	Description
0	Bit 0 to 3 Op Type	0 – Null 1 – Pulse On 2 – Pulse Off 3 – Latch On 4 – Latch Off
	Bit 4 Control Code	Reserved
	Bit 5 Control Code, Clear Field	Reserved
	Bit 6 to 7 Control Code, Trip-Close Code	This is used in conjunction with the Op Type to specify the control operation. 0 – Null 1 – Close 2 – Trip 3 - Reserved
1	Count	The number of times the operation must be executed (e.g., a number of pulses).
2 to 5	On-Time	The duration (in milliseconds) that the output must be on when pulsed.
6 to 9	Off Time	The duration (in milliseconds) that the output must be off when pulsed.
10	Status Code	In the request this must be zero.

DNP3 CROB parameters

13 Appendix B - CIP Object Reference

13.1 General Status

Request:

Parameter	Description
Service	Get Attribute Single
Class	0x40C (Hex)
Instance	1
Attribute	1

General Status - Request

Reply:

Offset	Parameter	Data Type	Comments
0	Status	INT	
0.0	Configuration Valid	BIT	
0.1	Routing Inhibited	BIT	
0.2	DNP3 Event Log Load Ok	BIT	
0.3	DNP3 Event Log Overflow	BIT	
0.4	Modbus Communications Ok	BIT	
0.5	Assign Class Dynamic Memory	BIT	Event Classes have been updated from dynamic assignments
0.6	Deadband Dynamic Memory	BIT	Deadbands have been updated from dynamic assignments
0.7	Unsolicited Dynamic Memory	BIT	Unsolicited Enables have been updated from dynamic assignments
2	Configuration Checksum	INT	
4	Mode	SINT	1 – Outstation (Fixed for DNPS)
5	Reserved	SINT	
6	Transaction Rate	INT	Number of complete Transactions per second
8	Reserved	DINT	
12	Operating Interface	SINT	0 - (EtherNet/IP) Logix 1 - (EtherNet/IP) Micro800 2 - (CIP USB) Logix 3 - Modbus TCP Slave 4 - Modbus RTU 232 Slave 5 - Modbus RTU 485 Slave 6 - Modbus TCP Master 7 - Modbus RTU 232 Master 8 - Modbus RTU 485 Master
13	DNP3 Protocol	SINT	0 - Serial RS232 1 - Ethernet TCP 2 - Ethernet UDP 3 - Serial RS485

General Status - Response

13.2 Time Status

Request:

Parameter	Description
Service	Get Attribute Single
Class	0x404 (Hex)
Instance	1
Attribute	1

General Status - Request

Reply:

Offset	Parameter	Data Type	Comments
0	Uptime	DINT	
4	Year	INT	
6	Month	SINT	
7	Day	SINT	
8	Hour	SINT	
9	Minute	SINT	
10	Second	SINT	
11	Process Cycles	DINT	
15	Device Temperature	REAL	

13.3 DNP3 Statistics

Request:

Parameter	Description
Service	Get Attribute Single
Class	0x40C (Hex)
Instance	1
Attribute	2

DNP3 Statistics - Request

Reply:

Offset	Parameter	Data Type	Comments
0	AppMsgSent	DINT	Operational Statistics
4	AppMsgReceived	DINT	
8	CriticalMsgReceived	DINT	
12	CriticalMsgSent	DINT	
16	DiscardedMsg	DINT	
20	ErrorMsgSent	DINT	
24	ErrorMsgReceived	DINT	
28	ChecksumError	DINT	
32	Timeout	DINT	
36	AssignClassReceived	DINT	
40	TimeUpdateReceived	DINT	
44	DeadbandUpdateReceived	DINT	
48	BroadcastMessageReceived	DINT	
52	UnsolicitedEventReceived	DINT	
56	SuccessAuthentication	DINT	Security Statistics
60	SessionKeyChanges	DINT	
64	FailedSessionKeyChanges	DINT	
68	UpdateKeyChanges	DINT	
72	AuthenticationFailure	DINT	
76	AuthorizationFailure	DINT	
80	UnexpectedResponse	DINT	
84	NoResponse	DINT	
88	AggressiveNotSupp	DINT	
92	MacAlgorithmNotSupp	DINT	
96	KeywrapAlgorithmNotSupp	DINT	Exception Statistics
100	UpdateKeyNotPermitted	DINT	
104	Unknown User	DINT	
108	LogixDNP3DataTypeMismatchRead	DINT	
112	LogixDNP3DataTypeMismatchWrite	DINT	
116	WriteSequenceIndexOutOfOrder	DINT	
120	TooMuchDataInDNP3Request	DINT	

124	MappedItemNotFound	DINT	
128	ReceivedEventItemNotFound	DINT	
132	TooManyDNP3ObjectsInRequest	DINT	
136	DNP3MessageQueueFull	DINT	
140	NodeNumberMismatch	DINT	
144	SelectSizeTooBig	DINT	
148	SelectOperateDataMismatch	DINT	
152	ParityError	DINT	
156	TransferKeyChanges	DINT	Enhanced Security Statistics

DNP3 Statistics - Response

13.4 DNP3 Event Statistics

Request:

Parameter	Description
Service	Get Attribute Single
Class	0x40C (Hex)
Instance	1
Attribute	3

DNP3 Event Statistics - Request

Reply:

Offset	Parameter	Data Type	Comments
0	DNP3 Group	SINT	Repeat this structure (49 bytes) for all 9 groups G02 - Binary Input Events G04 - Double-bit Binary Input Events G11 - Binary Output Events G13 - Binary Output Command Events G22 - Counter Events G23 - Frozen Counter Events G32 - Analog Input Events G42 - Analog Output Events G43 - Analog Output Command Events
	Event Class 1		
1	Reserved	INT	
3	Reserved	SINT	
4	Reserved	SINT	
5	Master 1		
5	Event Count	INT	
7	Reserved	INT	
9	Reserved	SINT	
10	Reserved	SINT	
11	Master 2		
11	Event Count	INT	
13	Reserved	INT	
15	Reserved	SINT	
16	Reserved	SINT	
	Event Class 2		
17	Reserved	INT	
19	Reserved	SINT	
20	Reserved	SINT	
21	Master 1		
21	Event Count	INT	
23	Reserved	INT	
25	Reserved	SINT	
26	Reserved	SINT	
27	Master 2		
27	Event Count	INT	
29	Reserved	INT	
31	Reserved	SINT	
32	Reserved	SINT	
	Event Class 3		
33	Reserved	INT	
35	Reserved	SINT	
36	Reserved	SINT	
37	Master 1		

37	Event Count	INT
39	Reserved	INT
41	Reserved	SINT
42	Reserved	SINT
43	Master 2	
43	Event Count	INT
45	Reserved	INT
47	Reserved	SINT
48	Reserved	SINT

DNP3 Event Statistics - Response

13.5 DNP3 Tag Mapping Statistics

Request:

Parameter	Description
Service	Get Attribute Single
Class	0x40C (Hex)
Instance	1
Attribute	4

DNP3 Tag Mapping Statistics - Request

Reply:

Offset	Parameter	Data Type	Comments
0	Current Class 3 Connections	DINT	
4	Connection Failures	DINT	
8	Tag Not Exist Errors	DINT	
12	Privilege Violations	DINT	
16	Tag Reads	DINT	
20	Tag Writes	DINT	
24	EtherNet/IP Retries	DINT	
28	EtherNet/IP Failures	DINT	
32	General Access Error	DINT	

DNP3 Tag Mapping Statistics – Response

14 Support, Service & Warranty

14.1 Contacting Technical Support

ProSoft Technology, Inc. is committed to providing the most efficient and effective support possible. Before calling, please gather the following information to assist in expediting this process:

- 1 Product Version Number
- 2 System architecture
- 3 Network details

If the issue is hardware related, we will also need information regarding:

- 1 Module configuration and associated ladder files, if any
- 2 Module operation and any unusual behavior
- 3 Configuration/Debug status information
- 4 LED patterns
- 5 Details about the interfaced serial, Ethernet or Fieldbus devices

Note: For technical support calls within the United States, ProSoft Technology's 24/7 after-hours phone support is available for urgent plant-down issues.

<p>North America (Corporate Location) Phone: +1.661.716.5100 info@prosoft-technology.com Languages spoken: English, Spanish REGIONAL TECH SUPPORT support@prosoft-technology.com</p>	<p>Europe / Middle East / Africa Regional Office Phone: +33.(0)5.34.36.87.20 france@prosoft-technology.com Languages spoken: French, English REGIONAL TECH SUPPORT support.emea@prosoft-technology.com</p>
<p>Latin America Regional Office Phone: +52.222.264.1814 latinam@prosoft-technology.com Languages spoken: Spanish, English REGIONAL TECH SUPPORT support.la@prosoft-technology.com</p>	<p>Asia Pacific Regional Office Phone: +60.3.2247.1898 asiapc@prosoft-technology.com Languages spoken: Bahasa, Chinese, English, Japanese, Korean REGIONAL TECH SUPPORT support.ap@prosoft-technology.com</p>

For additional ProSoft Technology contacts in your area, please visit:

www.prosoft-technology.com/About-Us/Contact-Us.

14.2 Warranty Information

For complete details regarding ProSoft Technology's TERMS & CONDITIONS OF SALE, WARRANTY, SUPPORT, SERVICE AND RETURN MATERIAL AUTHORIZATION INSTRUCTIONS, please see the documents at:

www.prosoft-technology/legal