

Time Sync

User Manual

A-TSM
A-TSM/B

Document No. D107-009
08/2025
Revision 1.32



CONTENTS

1. Preface	6
1.1. Introduction to the Time Sync module	6
1.2. Features.....	8
1.3. Architecture.....	9
1.4. Additional Information.....	11
1.5. Support.....	11
2. Installation	12
2.1. Module Layout	12
2.2. Module Mounting	14
2.3. Power	15
2.4. Antenna	15
2.5. Antenna cabling.....	16
2.6. Lightning Protection	17
2.7. Ethernet Port.....	18
3. Setup	19
3.1. Install Configuration Software	19
3.2. Network Parameters	19
3.3. Creating a New Project.....	24
3.4. Time Sync parameters.....	26
3.4.1. General.....	26
3.4.2. Time Services	27
3.4.3. Advanced	29
3.4.4. Remote Targets - Enhanced.....	30
3.4.5. Remote Target - Legacy	33
3.4.6. Modbus Server.....	34
3.5. Module Download.....	35
3.6. Logix Integration.....	37
3.6.1. RSLogix 5000 Configuration (PRe-Version 20)	37
3.6.2. Studio 5000 Configuration (Version 20+)	42
3.7. PC setup for NTP.....	46
3.8. Logix Time Synchronization Setup	47

3.8.1.	Logix Setup	47
4.	Device Firmware Update	49
5.	Operation	52
5.1.	Time Synchronization	52
5.1.1.	Source: GPS – Output: 1588 PTP.....	53
5.1.2.	Source: NTP Client – Output: 1588 PTP	53
5.1.3.	Source : GPS – Output: NTP Server	54
5.1.4.	Source: 1588 PTP – Output: NTP Server	54
5.1.5.	Legacy – Remote Target.....	55
5.2.	Positioning.....	56
5.3.	Velocity & odometer	57
5.4.	RSLogix / Studio 5000 assemblies	57
5.4.1.	Input Assembly.....	58
5.4.2.	Output Assembly.....	61
5.5.	Modbus Server Mapping.....	61
6.	Diagnostics	65
6.1.	LEDs	65
6.2.	Module Status Monitoring in Slate	66
6.2.1.	General.....	67
6.2.2.	GPS Status	68
6.2.3.	Time	70
6.2.4.	CIP Sync.....	71
6.2.5.	NTP	72
6.2.6.	Position	73
6.2.7.	Relative Position	74
6.2.8.	Distance.....	75
6.2.9.	Accuracy.....	76
6.2.10.	Satellites	77
6.2.11.	Remote Targets	77
6.2.12.	Modbus	78
6.2.13.	PCCC	80
6.2.14.	ENIP	81
6.2.15.	TCP / ARP	81

6.3. Module Event Log.....82

6.4. Web Server83

7. Technical Specifications85

7.1. Dimensions85

7.2. Electrical86

7.3. Ethernet.....86

7.4. GPS87

7.5. GPS Antenna.....87

7.6. 1588 PTP / NTP88

7.7. Legacy Device Time Synchronization88

7.8. Certifications89

Index.....90

Revision History

Revision	Date	Comment
1.0	13 Apr 2015	Initial document
1.1	29 May 2015	Update minimum Request Packet Interval (RPI) to 1ms from 10ms
1.2	25 August 2015	Add UL Listed mark
1.3	30 September 2015	Add indication that UTC time in input image is accurate time.
1.4	19 May 2016	Add ODVA Conformance mark
1.5	26 June 2016	Updated temperature range
1.6	11 August 2016	Added RoHS2 compliant to certifications
1.7	22 November 2016	Added Remote Target functionality.
1.8	23 May 2017	Add support for two additional interface modes. Add RCM Conformance mark.
1.9	5 July 2017	Added additional specifications Added support for 1588 PTP Peer-to-Peer (P2P) delay mechanism
1.10	29 August 2017	Added support for 1588 PTP holdover reporting
1.11	5 October 2017	Added UL Class 1 Division 2
1.12	22 November 2017	Added support for NTP Time source
1.13	4 May 2018	Added specification for 1588 PTP Network Transport UDP/IEEE802.3

1.14	5 June 2018	Added extended voltage range
1.15	30 April 2019	Added Time Sync Series B to user manual
1.16	25 October 2019	Added NTP connected to Logix input assembly status
1.17	12 November 2019	Added method of dynamically updating the Remote Target Time zone.
1.18	28 November 2019	Added Modbus Server functionality
1.19	5 August 2020	Increased ARP Connection count from 20 to 100
1.20	20 October 2020	Added GPS Position and Velocity data to Modbus mapping when operating as a Modbus Server.
1.21	6 January 2021	Added option for DIP Switch 4 – Fixed IP Address
1.22	13 April 2021	Updated UL Hazardous Certification (6.8)
1.23	4 March 2022	Added dual NTP server IP addresses
1.24	4 August 2022	Added information required for UL regarding open type device enclosures.
1.25	16 December 2022	Updated Modbus Date Time description.
1.26	15 January 2023	Added KCC certification.
1.27	17 January 2023	Update support contact details
1.28	28 March 2023	Added NTP Client Drift and Jump parameters. Added PTP Grandmaster indication. Add GPS Spoofing detection. Added time zone to Remote Targets. Added time zone when operating as a Modbus Server. Added Logix EDS AOP setup. Update Logix input assembly status bits.
1.29	6 October 2023	Fixed errors in section 5.1.
1.30	13 November 2023	Added UKCA Conformance Mark
1.31	26 January 2024	Added Enhanced Remote Target functionality
1.32	25 August 2025	Added maximum NTP and PTP Client count

1. PREFACE

1.1. INTRODUCTION TO THE TIME SYNC MODULE

This manual describes the installation, operation, and diagnostics of the Aparian Time Sync module. The Time Sync module provides high accuracy time synchronization across traditional Ethernet networks using 1588 Precision Time Protocol (PTP) as well as Network Time Protocol (NTP).

The module is also capable of writing time information directly to Allen-Bradley MicroLogix, SLC500, PLC5 and Micro800 devices, as well as any Modbus-TCP Server device.

The Time Sync module can also operate as a Modbus TCP Server where a Modbus TCP Master can read the relevant time data from the Time Sync module.

The Time Sync module also provides GPS position and velocity data using the on-board GPS receiver. The Time Sync module is a stand-alone device allowing it to serve a wide variety of platforms.

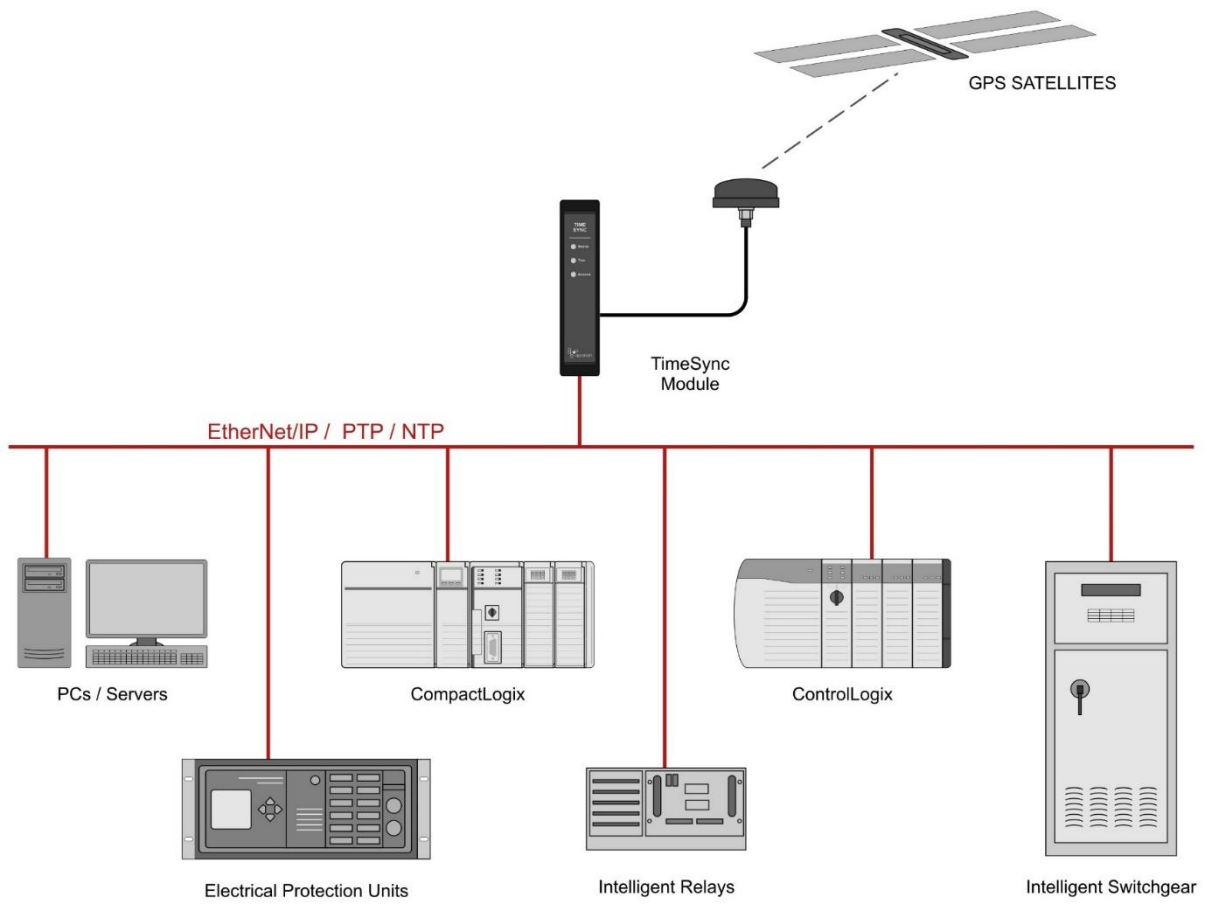

Figure 1.1. – Typical architecture

1.2. FEATURES

The Time Sync module provides a cost-effective solution for high accuracy time synchronization across a range of applications. The Time Sync module also provides the user with position and velocity information using GPS.

Mode	Description
Time	The module is configured to only use the GPS constellation for best time accuracy.
Position	The module is configured to use GPS, SBAS and GLONASS satellite constellations to provide the most accurate positioning information.
Custom	This mode allows the user to select the constellations that are needed for the required application.

Table 1.1. – Modes of Operation

The Time Sync module is configured using the Aparian Slate application. This program can be downloaded from www.aparian.com free of charge. Slate offers various configuration methods, including a controller tag browser.

Hereafter the Time Sync module will be referred to as the **module**.

The module is a stand-alone device allowing it to operate across various platforms. The module can also seamlessly connect and integrate with Rockwell Automation’s Allen Bradley equipment. The module can operate in either a Logix “owned” or standalone mode. In stand-alone mode the module can be configured and connected to an Ethernet network to accurately synchronize devices using 1588 PTP and NTP. With a Logix connection the input and output assemblies will provide timing, positioning, and diagnostic information which will be available in the Logix controller environment in addition to the PTP and NTP services.

The module uses an on-board GPS receiver to provide accurate time and position information. Because the module is stand-alone and connects to various devices over an Ethernet network the module can be placed as close as possible to the antenna position removing the need for costly low-loss coaxial cables.

The on-board GPS receiver also provides velocity and an odometer reading allowing the user to implement the module in various vehicle and tracking applications. The GPS accuracy information provides the user/controller with quality metrics for the position, velocity, and odometer information.

A built-in webserver provides detailed diagnostics of system configuration and operation, including the display of GPS time, position, and velocity, without the need for any additional software.

1.3. ARCHITECTURE

The figure below provides an example of the typical network setup.

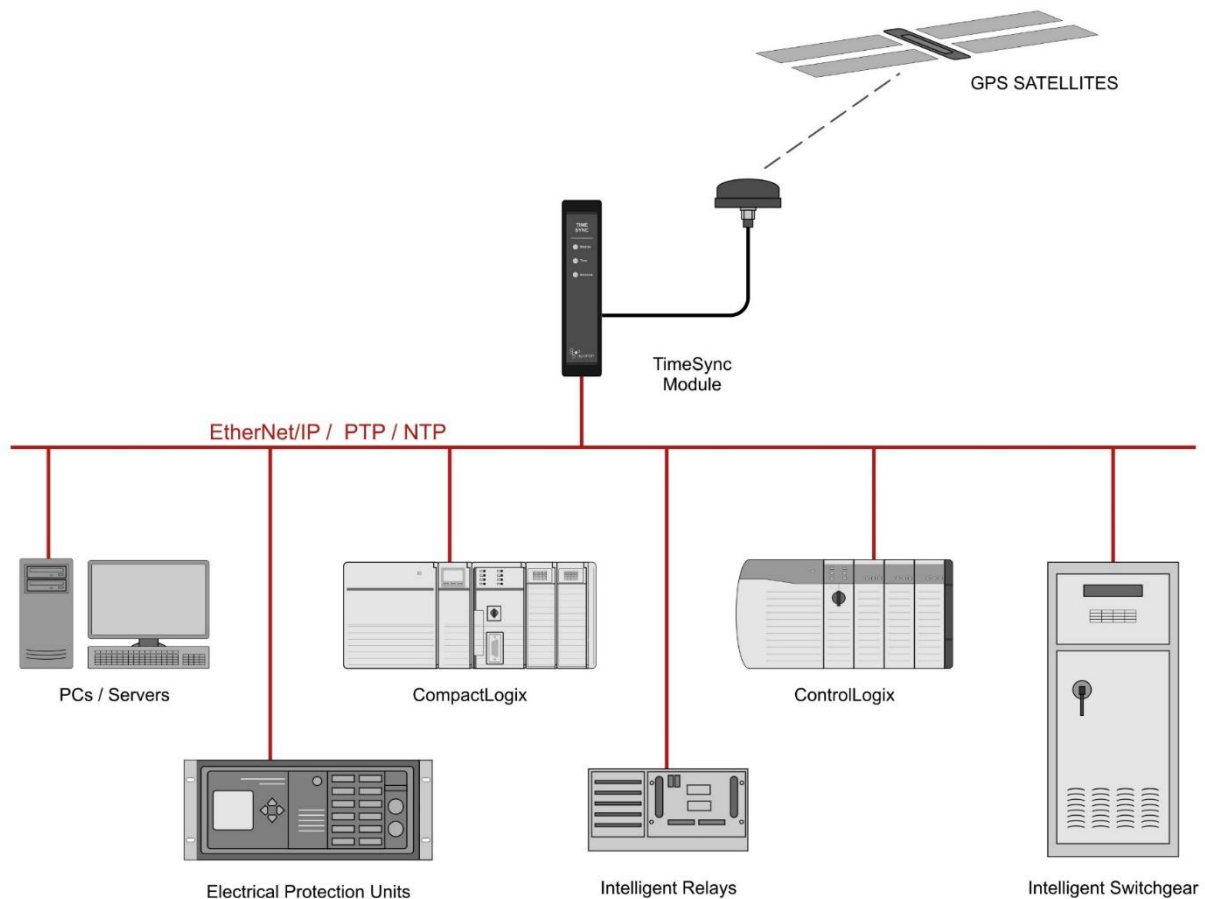

Figure 1.2. - Example of a typical network setup for a timing application

The module can synchronize various devices across various platforms over traditional Ethernet using 1588 PTP and NTP.

With position, velocity, and odometer information various tracking and positioning applications can be implemented.

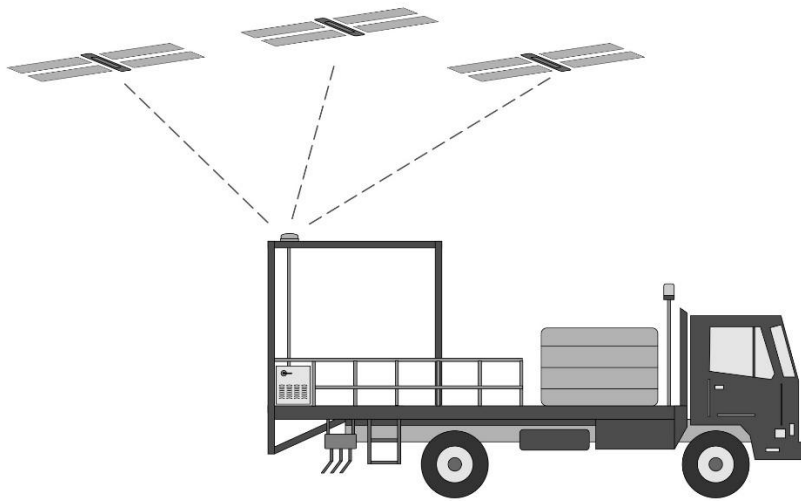

Figure 1.3. - Example of a typical position and velocity application

Using the accuracy information provided calculated decisions can be made for various positioning applications including collision warning and avoidance systems.

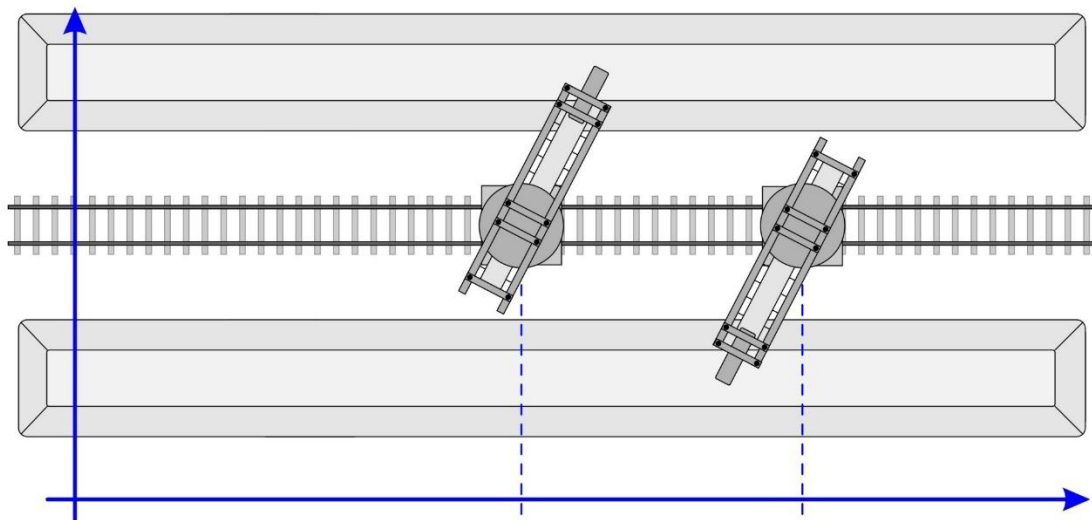

Figure 1.4. – Stacker / Reclaimer Example

1.4. ADDITIONAL INFORMATION

The following documents contain additional information that can assist the user with the module installation and operation.

Resource	Link
Slate Installation	http://www.aparian.com/software/slate
Time Sync User Manual Time Sync Datasheet Example Code & UDTs	http://www.aparian.com/products/timesync
Ethernet wiring standard	www.cisco.com/c/en/us/td/docs/video/cds/cde/cde205_220_420/installation/guide/cde205_220_420_hig/Connectors.html
GPS information	https://www.u-blox.com/images/stories/the_gps_dictionary.pdf
1588 Precision Time Protocol (PTP)	http://www.ieee1588.com/
Network Time Protocol (NTP)	http://www.ntp.org/documentation.html
CIPSync	https://www.odva.org/Home/ODVATECHNOLOGIES/CIP/CIPTechnologyOverview/CIPSync.aspx

Table 1.2. - Additional Information

1.5. SUPPORT

Technical support is provided via the Web (in the form of user manuals, FAQ, datasheets etc.) to assist with installation, operation, and diagnostics.

For additional support the user can use either of the following:

Resource	Link
Contact Us web link	https://www.prosoft-technology.com/Services-Support/Customer-Support
Support email	support@prosoft-technology.com

Table 1.3. – Support Details

2. INSTALLATION

2.1. MODULE LAYOUT

The module has three ports at the bottom of the enclosure as shown in the figure below. The ports are used for Ethernet, GPS antenna and power. The power port uses a three way connector which is used for the DC power supply and the earth connection.

The GPS antenna connector provides connection to the provided GPS antenna.



NOTE: The module is supplied with a GPS antenna. Various other GPS antennas can be used Care must be taken to ensure they comply with the receiver antenna specifications.

The Ethernet cable must be wired according to industry standards which can be found in the additional information section of this document.

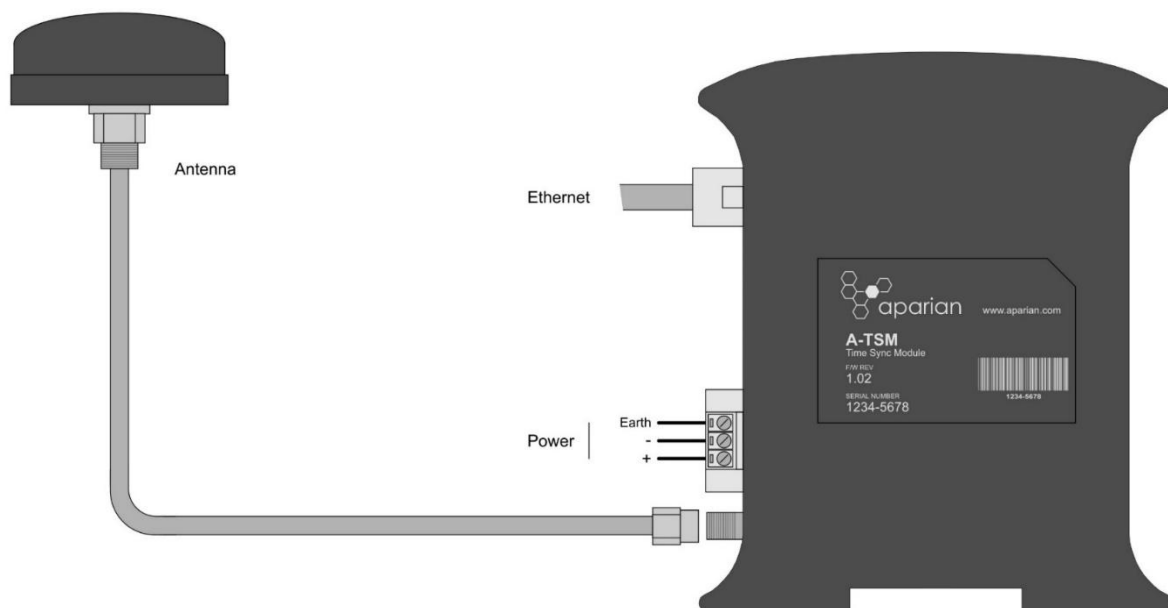

Figure 2.1. – Time Sync module side view



Figure 2.2. - Time Sync module bottom view

The module provides three diagnostic LEDs as shown in the front view figure below. These LEDs are used to provide information regarding the module system operation, the Ethernet interface, and the GPS receiver pulse-per-second (PPS).



Figure 2.3. – Time Sync front and top view

The module provides four DIP switches at the top of the enclosure as shown in the top view figure above.

DIP Switch	Description
DIP Switch 1	Used to force the module into “Safe Mode”. When in “Safe Mode” the module will not load the application firmware and will wait for new firmware to be downloaded. This should only be used in the rare occasion when a firmware update was interrupted at a critical stage.
DIP Switch 2	This will force the module into DHCP mode which is useful when the user has forgotten the IP address of the module.
DIP Switch 3	Reserved
DIP Switch 4	When this DIP Switch is set at bootup it will force the module Ethernet IP address to 192.168.1.100 and network mask 255.255.255.0. The user can then switch the DIP switch off and assign the module a static IP address if needed.

Table 2.1. - DIP Switch Settings

2.2. MODULE MOUNTING



NOTE: This module is an open-type device and is meant to be installed in an enclosure suitable for the environment such that the equipment is only accessible with the use of a tool.

The module provides a DIN rail clip to mount onto a 35mm DIN rail.

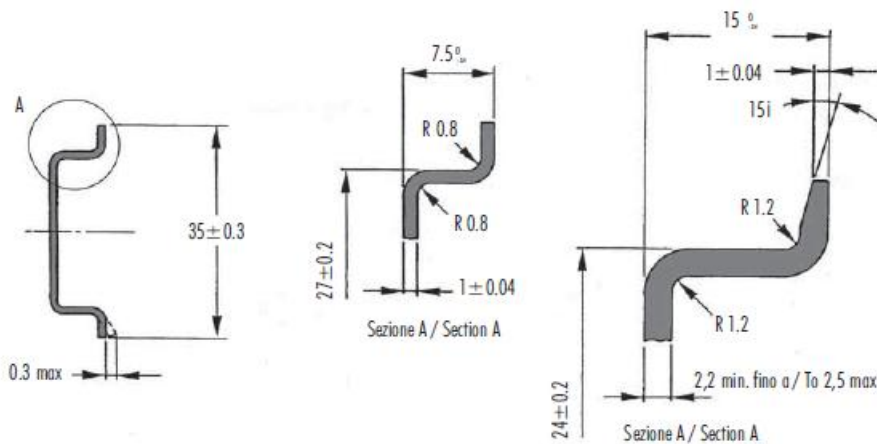

Figure 2.4 - DIN rail specification

The DIN rail clip is mounted on the bottom of the module at the back as shown in the figure below. Use a flat screwdriver to pull the clip downward. This will enable the user to mount the module onto the DIN rail. Once the module is mounted onto the DIN rail the clip must be pushed upwards to lock the module onto the DIN rail.

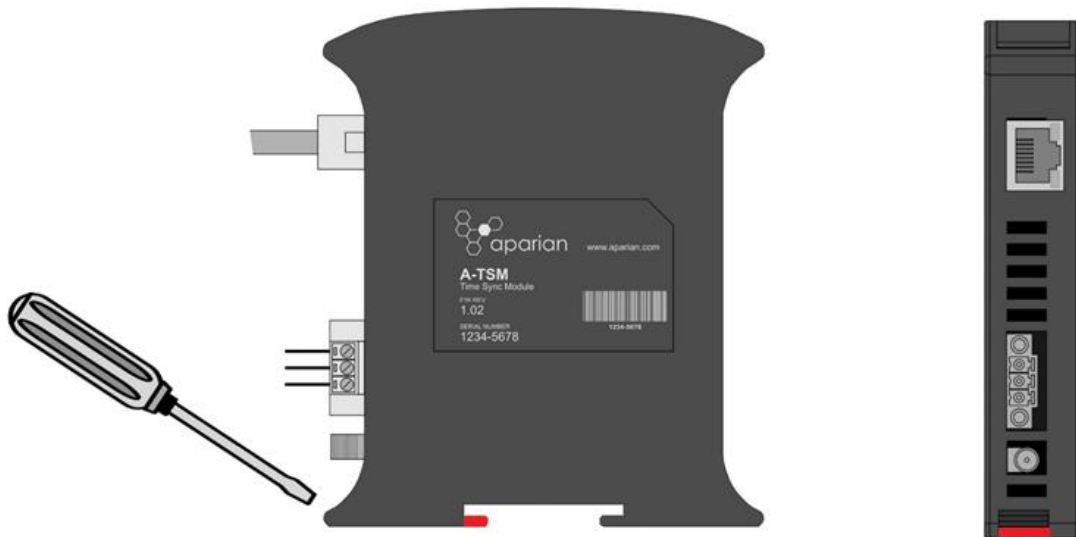

Figure 2.5 - DIN rail mounting

2.3. POWER

A three-way power connector is used to connect Power+, Power– (ground), and earth. The module requires an input voltage of 10 – 28Vdc. **Refer** to the technical specifications section in this document.

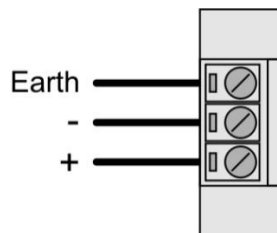

Figure 2.6 - Power connector

2.4. ANTENNA

The supplied GPS antenna must be connected to the SMA antenna port. The GPS antenna must be mounted in such a way to provide the maximum view of the sky. The less restricted the view the antenna has of the sky, the better the accuracy the module will be able to provide.

Various indicators can be used to assess the quality of the antenna's view of the sky. These indicators, listed in Table 2.2 below can be found in the Status page of the module in Slate, as well as the input assembly when connected to an Allen-Bradley controller.

Indicator	Description
Satellite Count	The satellite count is the number of satellites the GPS receiver is currently tracking. If this number is low (< 5) then the antenna is either mounted incorrectly, the antenna cable is damaged, or there is interference with the GPS signal.
PDOP	Position Dilution Of Precision is the measure of accuracy in a 3-Dimensional position. Refer to table 2.3 for a meaning of DOP values. Refer to section 1.4 for additional information regarding GPS DOP values.
HDOP	Horizontal Dilution Of Precision is the measure of accuracy in a 2- Dimensional position (e.g. latitude and longitude). Refer to table 2.3 for a meaning of DOP values. Refer to section 1.4 for additional information regarding GPS DOP values.
VDOP	Vertical Dilution Of Precision is the measure of accuracy in a 1- Dimensional position (e.g. altitude). Refer to table 2.3 for a meaning of DOP values. Refer to section 1.4 for additional information regarding GPS DOP values.

Table 2.2. – Antenna sky view quality indicators

Dilution of precision values are used to indicate if satellites are clustered into a single area of the sky which can indicate the antenna has an obstructed view of the sky. Below is a general indication of DOP values:

DOP Value	Rating
< 1	Ideal
1-2	Excellent
2-5	Good
5-10	Moderate
10-20	Fair
>20	Poor

Table 2.3. – DOP value indicators

2.5. ANTENNA CABLING

The supplied antenna has the 3m antenna cable. This may be extended by the use of additional lengths 50 Ohm coaxial cable.

Cable Type	Max. Length	Loss / 100ft at 1.5GHz	Min Bend Radius (Inches)	Cable Diameter (Inches)	Connector Types
RG58/U	15m / 50ft	18.0 dB	2"	0.193"	SMA, TNC
LMR240	30m / 100ft	9.87 dB	0.75"	0.240"	SMA, TNC, N
LMR400	55m / 180ft	5.13 dB	1"	0.405"	TNC, N
LMR600	90m / 300ft	3.32 dB	1.5"	0.590"	TNC, N

Table 2.4. - Cable Extension Options

It is recommended that this cable use male connectors and adaptors and bulkhead connectors use female. LMR400 and LMR600 cable cannot be connected directly to the module because the SMA antenna connector on the modules cannot support the weight of these cables. It is recommended that a short RG58/U fly lead be used to connect the thicker coax to the module.

For example, if a 150ft extension is required:

Component	Connector
Antenna	SMA Male
Adaptor	SMA Female to TNC Female
Extension Cable LMR400	TNC Male to TNC Male 150ft
Bulkhead Adaptor	TNC Female to TNC Female
Fly Lead Cable RG58/U	TNC Male to SMA Male 3ft
Module	SMA Female

Table 2.5. – Cable Example

It is recommended that the antenna cable extensions be minimized by moving the module closer to the antenna. However, if longer extensions are required, an amplifier can be used. Amplifiers should have DC pass through capability and a gain that makes up for the cable attenuation. Amplifiers need to be mounted at the antenna end of the extension cable.

2.6. LIGHTNING PROTECTION

Lightning strike protection can be added to the antenna cable circuit. As with the amplifier the arrestor needs to pass DC power to the antenna and have a pass band around 1.5GHz . The *PolyPhaser DGXZ+15TTF-A* is an example of a suitable arrestor. Care must be taken to follow the manufacturer’s installation instructions.



Figure 2.7. - Lightning Arrestor

2.7. ETHERNET PORT

The Ethernet connector should be wired according to industry standards. Refer to the additional information section in this document for further details.

3. SETUP

3.1. INSTALL CONFIGURATION SOFTWARE

All the network setup and configuration of the module is achieved by means of the Aparian Slate device configuration environment. This software can be downloaded from <http://www.aparian.com/software/slate>.

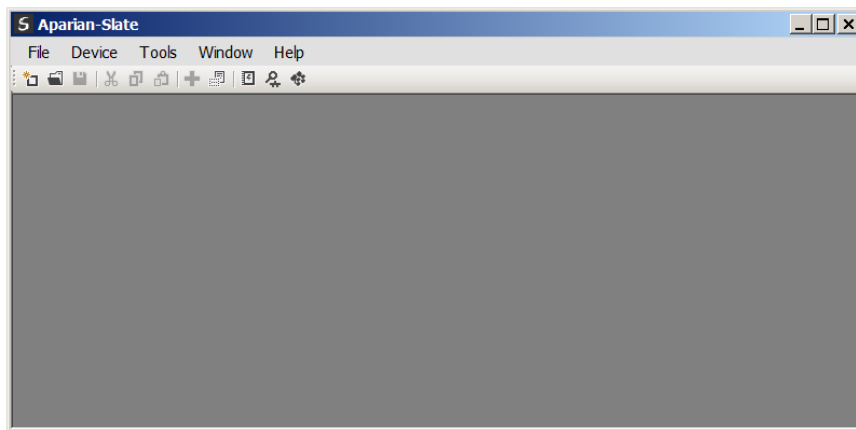

Figure 3.1. - Aparian Slate Environment

3.2. NETWORK PARAMETERS

The module will have DHCP (Dynamic Host Configuration Protocol) enabled as factory default. Thus, a DHCP server must be used to provide the module with the required network parameters (IP address, subnet mask, etc.). There are a number of DHCP utilities available, however it is recommended that the DHCP server in Slate be used.

Within the Slate environment, the DHCP server can be found under the Tools menu.

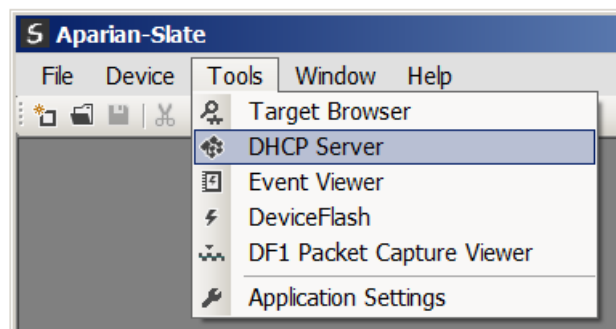

Figure 3.2. - Selecting DHCP Server

Once opened, the DHCP server will listen on all available network adapters for DHCP requests and display their corresponding MAC addresses.

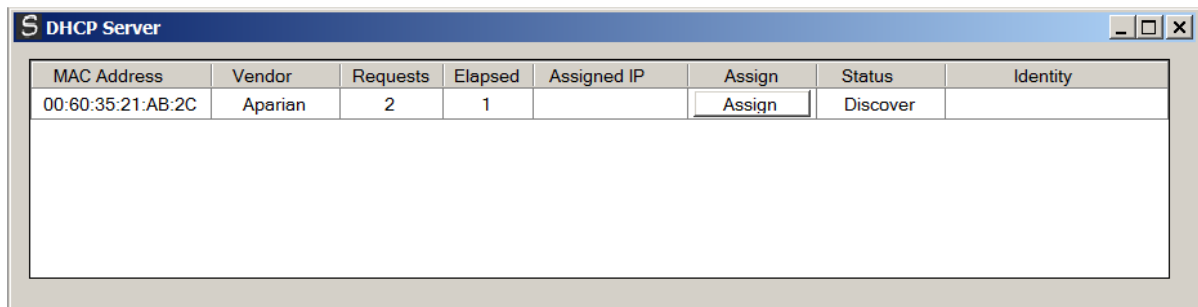

Figure 3.3. - DHCP Server



NOTE: If the DHCP requests are not displayed in the DHCP Server it may be due to the local PC's firewall. During installation the necessary firewall rules are automatically created for the Windows firewall. Another possibility is that another DHCP Server is operational on the network and it has assigned the IP address.

To assign an IP address, click on the corresponding "Assign" button. The IP Address Assignment window will open.

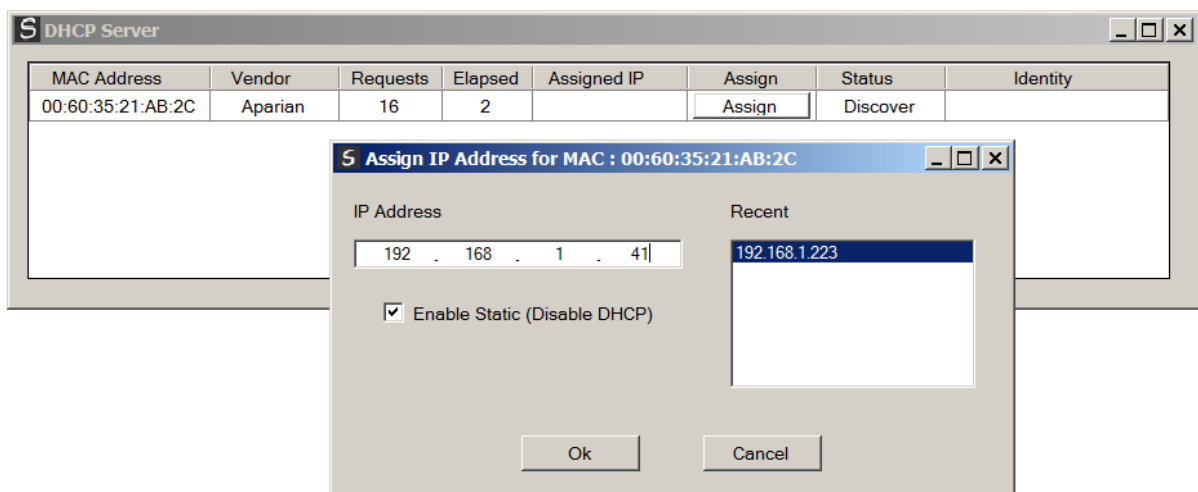

Figure 3.4. - Assigning IP Address

The required IP address can then be either entered, or a recently used IP address can be selected by clicking on an item in the Recent List.

If the "Enable Static" checkbox is checked, then the IP address will be set to static after the IP assignment, thereby disabling future DHCP requests.

Once the IP address window has been accepted, the DHCP server will automatically assign the IP address to the module and then read the Identity object Product name from the device.

The successful assignment of the IP address by the device is indicated by the green background of the associated row.

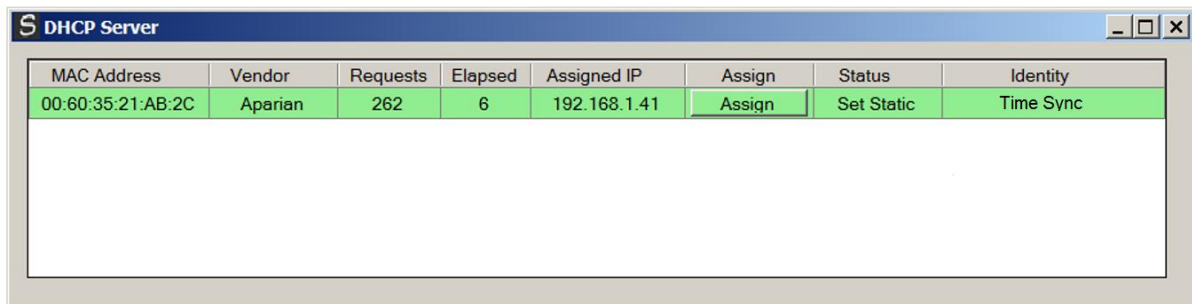

MAC Address	Vendor	Requests	Elapsed	Assigned IP	Assign	Status	Identity
00:60:35:21:AB:2C	Aparian	262	6	192.168.1.41	Assign	Set Static	Time Sync

Figure 3.5. - Successful IP address assignment

It is possible to force the module back into DHCP mode by powering up the device with DIP switch 2 set to the On position.

A new IP address can then be assigned by repeating the previous steps.



NOTE: It is important to return DIP switch 2 back to Off position, to avoid the module returning to a DHCP mode after the power is cycled again.

If the module's DIP switch 2 is in the On position during the address assignment, the user will be warned by the following message.

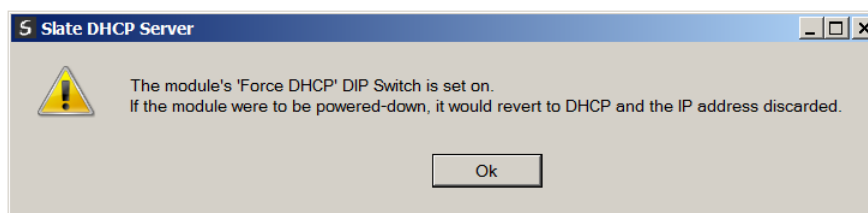

Figure 3.6. - Force DHCP warning

In addition to the setting the IP address, a number of other network parameters can be set during the DHCP process. These settings can be viewed and edited in Slate's Application Settings, in the DHCP Server tab.

Once the DHCP process has been completed, the network settings can be set using the Ethernet Port Configuration via the Target Browser.

The Target Browser can be accessed under the Tools menu.

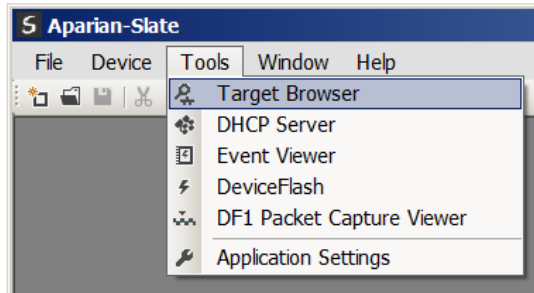

Figure 3.7. - Selecting the Target Browser

The Target Browser automatically scans the Ethernet network for EtherNet/IP devices.

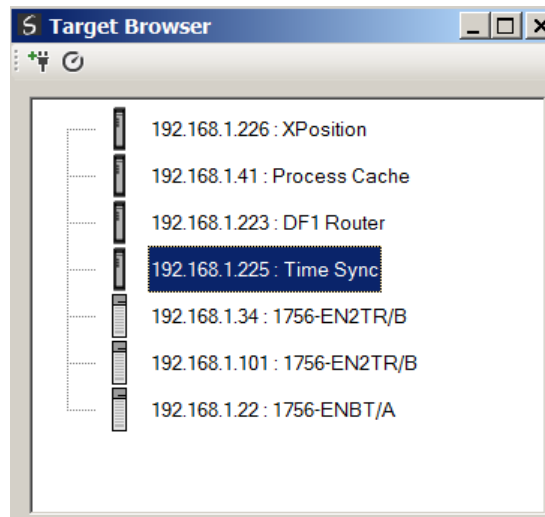

Figure 3.8. - Target Browser

Right-clicking on a device, reveals the context menu, including the Port Configuration option.

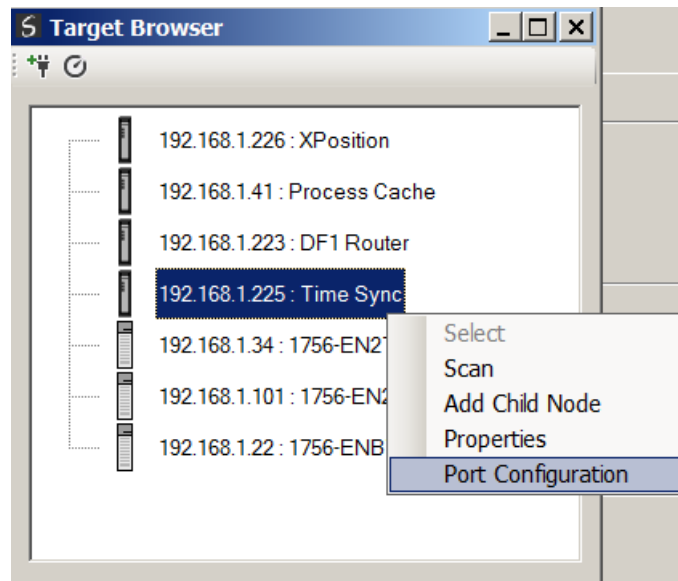

Figure 3.9. - Selecting Port Configuration

All the relevant Ethernet port configuration parameters can be modified using the Port Configuration window.

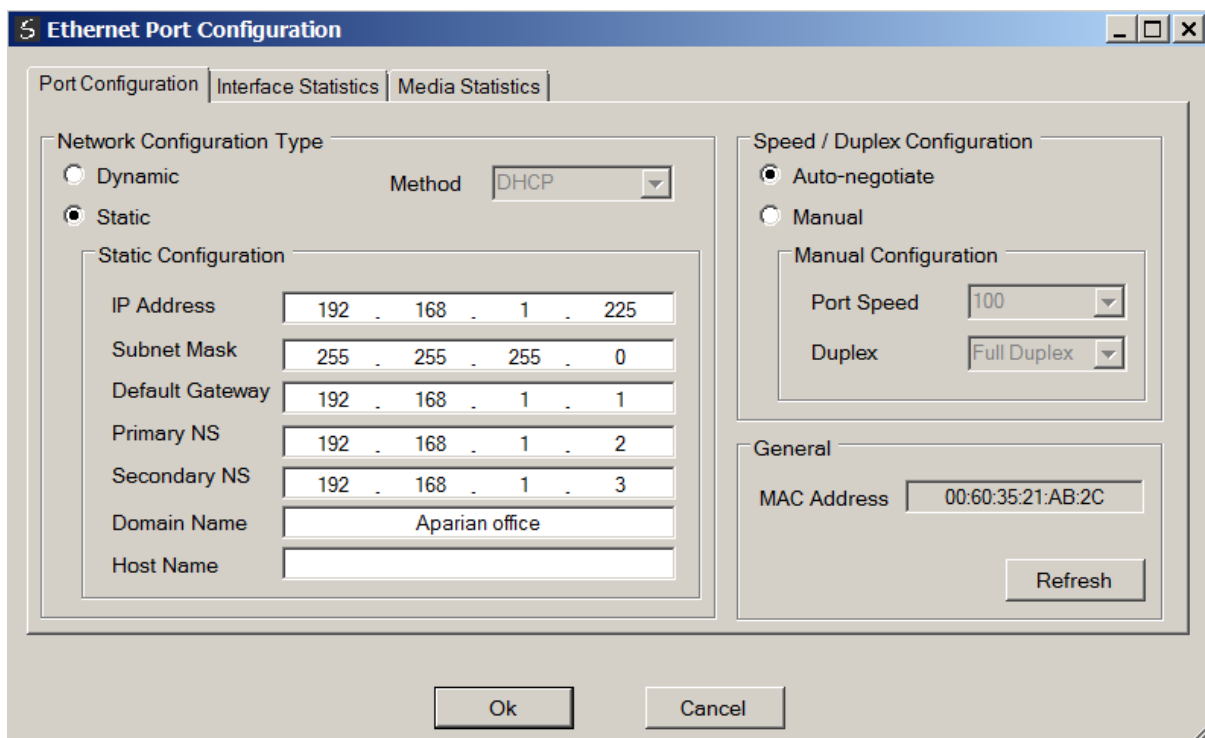

Figure 3.10. - Port Configuration

Alternatively, these parameters can be modified using Rockwell Automation's RSLinx software.

3.3. CREATING A NEW PROJECT

Before the user can configure the module, a new Slate project must be created. Under the File menu, select New.

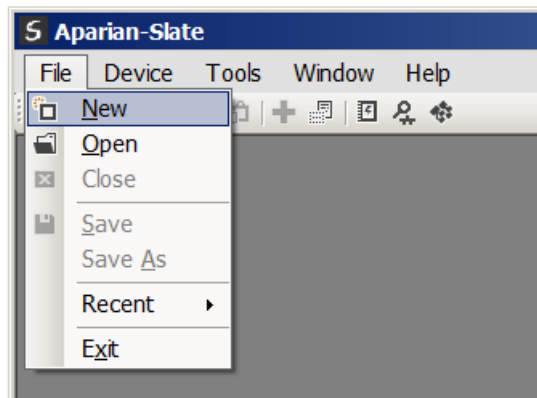

Figure 3.11. - Creating a new project

A Slate project will be created, showing the Project Explorer tree view. To save the project use the Save option under the File menu.

A new device can now be added by selecting Add under the Device menu.

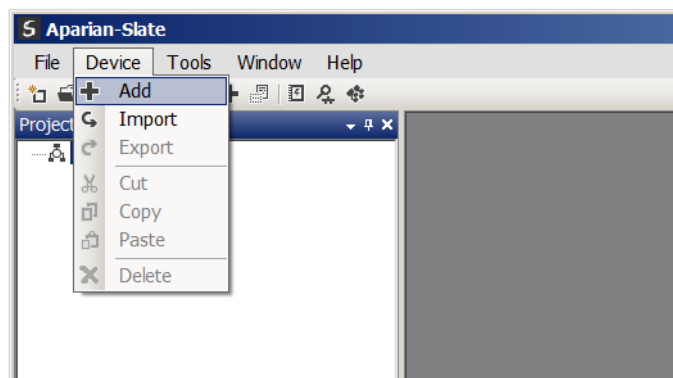

Figure 3.12. - Adding a new device

In the Add New Device window select the Time Sync module and click the Ok button.

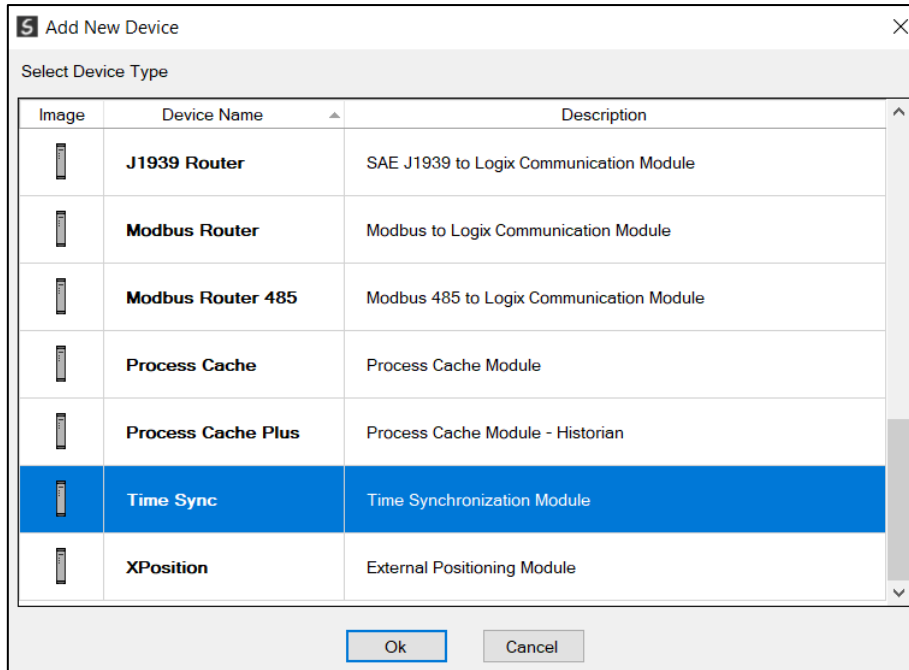

Figure 3.13 – Selecting a new Time Sync module.

The device will appear in the Project Explorer tree as shown below, and its configuration window opened.

The device configuration window can be reopened by either double clicking the module in the Project Explorer tree or right clicking the module and selecting *Configuration*.

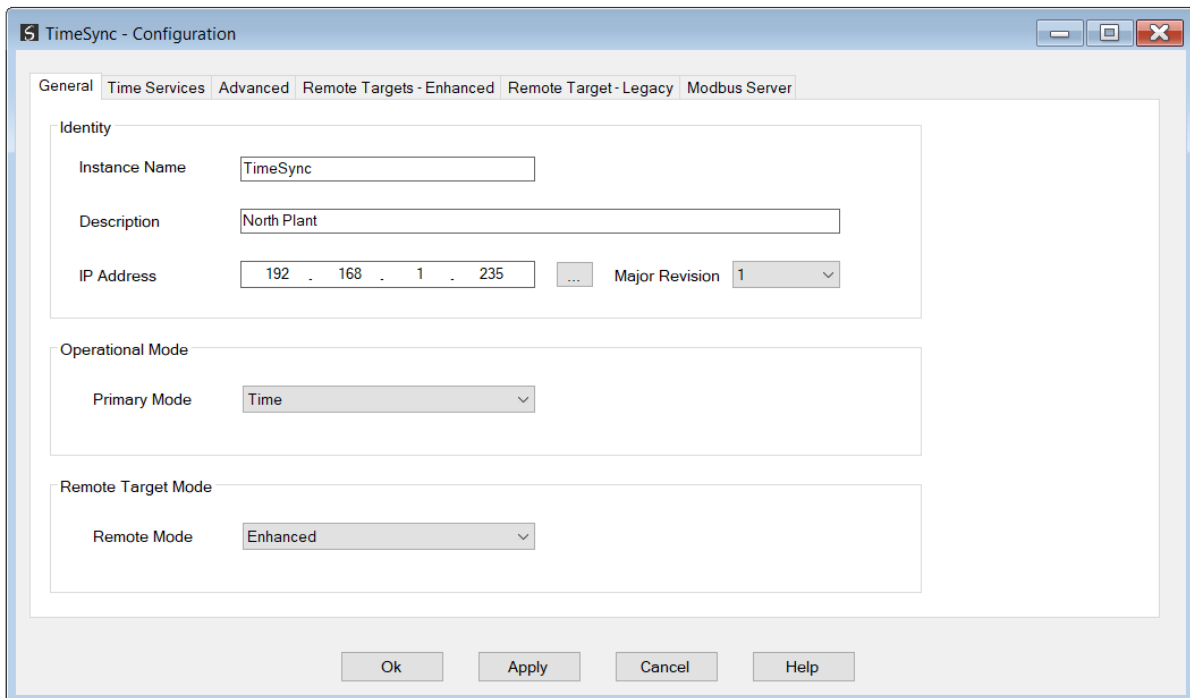

Figure 3.14. – Time Sync module configuration.

Refer to the additional information section in this document for Slate's installation and operation documentation.

3.4. TIME SYNC PARAMETERS

The Time Sync module parameters will be configured by Slate. **Refer** to the additional information section for documentation and installation links for Aparian Slate. The Time Sync parameter configuration consists of a general configuration as well as advanced configuration. When downloading this configuration into the module it will be saved in non-volatile memory that persists when the module is powered down.



NOTE: When a firmware upgrade is performed the module will clear all Time Sync configuration.

3.4.1. GENERAL

The general configuration is shown in the figure below. The Time Sync general configuration window is opened by either double clicking on the module in the tree or right-clicking the module and selecting *Configuration*.

The screenshot shows a window titled "TimeSync - Configuration" with a standard Windows-style title bar (minimize, maximize, close buttons). The window has several tabs: "General", "Time Services", "Advanced", "Remote Targets - Enhanced", "Remote Target - Legacy", and "Modbus Server". The "General" tab is selected. The "Identity" section contains three input fields: "Instance Name" with the value "TimeSync", "Description" with the value "North Plant", and "IP Address" with the value "192 . 168 . 1 . 235". To the right of the IP address field is a "Major Revision" dropdown menu set to "1". The "Operational Mode" section has a "Primary Mode" dropdown menu set to "Time". The "Remote Target Mode" section has a "Remote Mode" dropdown menu set to "Enhanced". At the bottom of the window are four buttons: "Ok", "Apply", "Cancel", and "Help".

Figure 3.15. - General Configuration.

The general configuration consists of the following parameters:

Parameter	Description
Instance Name	This parameter is a user defined name to identify between various Time Sync modules.
Description	This parameter is used to provide a more detail description of the application for the module.
IP Address	The IP address of the target module
Major Revision	The major revision of the module
Primary mode	<p>There are three primary modes that can be selected for the Time Sync module.</p> <p>Time When time is selected as the primary mode the module will configure the GPS receiver to provide maximum time accuracy. This is achieved by enabling only the GPS satellite constellation.</p> <p>Position When position is selected as the primary mode the module will configure the GPS receiver to provide maximum position accuracy. This is achieved by enabling GPS, SBAS, and the GLONASS satellite constellations.</p> <p>Custom When custom is selected the user can preselect the satellite constellations required in the advanced configuration.</p>
Remote Target Mode	<p>There are two Remote Target Modes:</p> <p>Legacy In Legacy mode, only a single remote target can be selected.</p> <p>Enhanced In Enhanced mode, up to 10 remote targets can be selected.</p> <p>NOTE: The Enhanced mode requires module firmware revision 1.023 or greater.</p>

Table 3.1. - General configuration parameters.

3.4.2. TIME SERVICES

The Time Services configuration is shown in the figure below. The configuration window is opened by either double clicking on the module in the tree or right-clicking the module followed by selecting *Configuration*. Once in the configuration window select the **Time Services** tab.

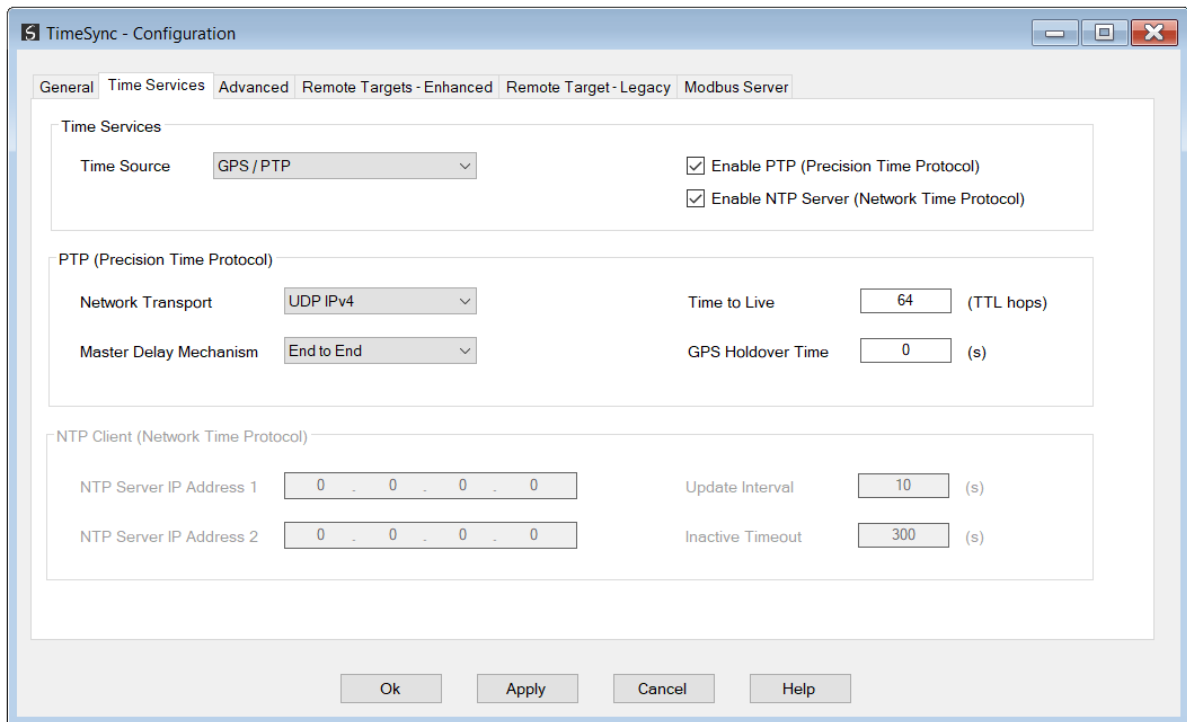

Figure 3.16. - Time Services Configuration.

The **Time Services** configuration consists of the following parameters:

Parameter	Description
Time Source	The TSM can retrieve its time from either of the following: <ul style="list-style-type: none"> GPS/PTP – Using the GPS system or if this is not available from another 1588 PTP Master on the network. NTP – The TSM can connect to a NTP server and retrieve its time. The user can select either NTP Client or NTP Symmetric.
Enable PTP	The user can enable/disable the 1588 PTP functionality on the module. Thus, the module will not send out any PTP Sync, Follow-up, or Delay Response messages.
Enable NTP	The user can enable/disable the NTP functionality on the module. Thus, the module will not respond to any NTP requests.
Master Delay Mechanism	When operating as a 1588 PTP Grandmaster the module can support either of the following 1588 PTP delay mechanisms: <ul style="list-style-type: none"> End-to-End (E2E) Peer-to-Peer (P2P)
TTL	The Time-To-Live parameter for PTP. The number of network hops the PTP message can take before it is discarded.
GPS Holdover Time	The time (in seconds) the Time Sync Module will keep reporting a 1588 PTP Clock Class <i>Primary Reference Hold</i> after it has lost a fix on the GPS satellites (the Primary Reference). This will allow the Time Sync Module to still be the PTP Master for a configurable amount of time once the GPS fix has been lost.
NTP Server IP Address 1	The IP Address of the Primary NTP Server which will be used as a Time source

NTP Server IP Address 2	The IP Address of the Secondary NTP Server which will be used as a Time source
Update Interval	This is how often (in seconds) the TSM will contact the NTP Server to retrieve time.
Inactive Time	This is for how long the TSM must not have heard from the NTP Server before setting the NTP Server connected to false.

Table 3.2. – Time Services configuration parameters.

3.4.3. ADVANCED

The Advanced configuration is shown in the figure below. This configuration window is opened by either double clicking on the module in the tree or right clicking the module followed by selecting *Configuration*. Once in the configuration window select the **Advanced** tab.

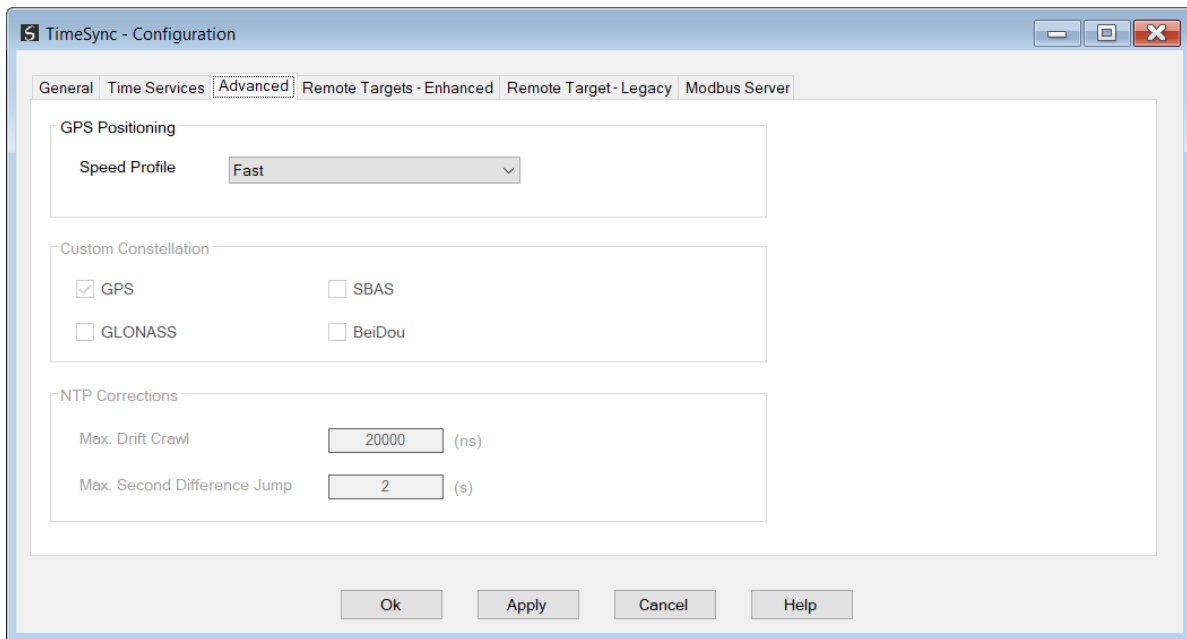

Figure 3.17 - Advanced configuration.

The **Advanced** configuration consists of the following parameters:

Parameter	Description
Speed profile	<p>There are two speed profiles that can be configured for the Time Sync module. These profiles allow for the most accurate odometer readings for a given speed.</p> <p>Fast</p> <p>In this mode the GPS receiver will be configured to provide the most accurate odometer reading for fast moving (e.g. vehicle).</p> <p>Slow</p>

	In this mode the GPS receiver will be configured to provide the most accurate odometer reading for slow moving (e.g. walking).
Custom Constellation	The custom constellation will only be available when the user has selected the Custom primary mode in the general configuration. This setting allows the user to select which constellations must be used for the solution. The options are GPS, GLONASS, SBAS, and BeiDou.
NTP Corrections	
Max. Drift Crawl	The maximum rate (in nanosecond) at which the 1588 PTP clock is allowed to crawl to the desired time when operating as a NTP Client and a 1588 PTP Master. Default: 20,000ns
Max. Second Difference Jump	The maximum time difference (in seconds) between the NTP Server and the TSM module before the 1588 PTP time is corrected with a step change. Default: 2s

Table 3.3. - Advanced configuration parameters.



NOTE: When GPS is selected, either GLONASS or BeiDou can be selected, but not both simultaneously.

3.4.4. REMOTE TARGETS - ENHANCED

The **Remote Targets – Enhanced** configuration is shown in the figure below. This configuration window is opened by either double clicking on the module in the tree or right clicking the module followed by selecting *Configuration*. Once in the configuration window select the **Remote Targets – Enhanced** tab.

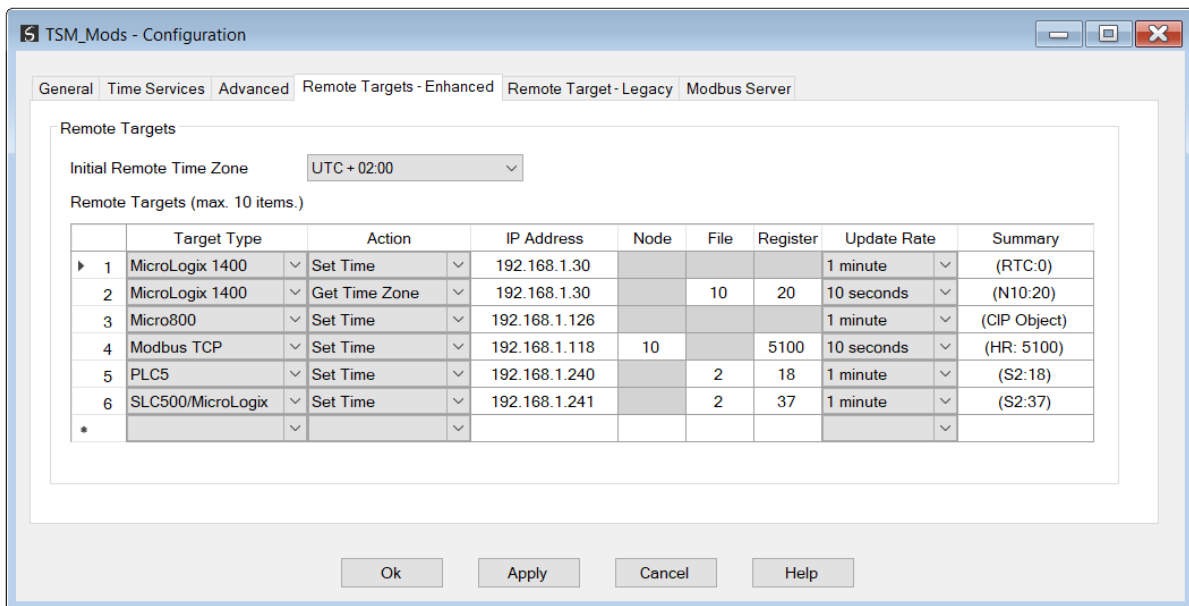

Figure 3.18 – Remote Targets – Enhanced configuration.



NOTE: The *Remote Targets – Enhanced* mode requires module firmware revision 1.023 or greater.

The *Remote Targets - Enhanced* configuration consists of the following parameters:

Parameter	Description
Initial Remote Time Zone	The internal Time Zone to be used until the first Get Time Zone action is taken. This value is used after the Time Sync module powers-up.
Remote Target List – A Maximum of 10 Remote Target Items can be added.	
Target Type	The remote device type, either: <ul style="list-style-type: none"> • PLC5 • SLC500 / MicroLogix (except MicroLogix 1400) • Modbus TCP • MicroLogix 1400 • Micro800
Action	The action to be taken: <p>Set Time</p> <p>The Set Time action writes the local time (using the current internal Time Zone) to the target. The type of message sent depends on the Remote Target Type.</p> <p>Get Time Zone</p> <p>The Get Time Zone action reads a tag or register from the Remote Target and updates the internal Time Zone value with this value.</p> <p>NOTE: The Time Zone value is expected to be a signed integer value in minutes. For example: A value of 120 would indicate a time zone of UTC + 2 (120 minutes = 2hours). A value of -180 would indicate a time zone of UTC - 3 (180 minutes = 3hours).</p> <p>NOTE: Only 1 Get Time Zone item is allowed in the list.</p>
IP Address	The IP Address of the remote device.
Node	The Modbus node address. (Only applicable for Modbus TCP.)
File	PLC Data file number. (Only applicable for PLC5, SLC500 and MicroLogix.)
Register	PLC Data register (PLC5, SLC500 and MicroLogix) or Modbus holding register (Modbus TCP)
Update Rate	The rate at which the Time is written to the remote device. Options include: <ul style="list-style-type: none"> • 1 second • 10 seconds • 1 minute • 30 minutes

	<ul style="list-style-type: none"> • 1 hour • 6 hours • 12 hours • 24 hours
Summary	A summary of the target object, tag or register to be read from, or written to.

Table 3.4. – Remote Targets – Enhanced configuration parameters



WARNING: Care must be taken when selecting the remote device and register. Incorrect configuration, and the subsequent module writing to incorrect PLC addresses or Modbus registers, may have unexpected consequences and could result in personal injury and/or equipment damage.

The user can also dynamically update the Remote Time Zone by using a Logix Message Instruction. The user will need to send an INT with the number of minutes for the time zone adjustment (including the day light saving if applicable). For example;

- If the time zone is GMT + 2, then the user will need to send 120.
- If the time zone is GMT – 3.5, then the user will need to send -210.

3.4.4.1. TIME ZONE CIP MESSAGE:

Parameter	Description
Service Code	0x10 (Hex) – Set Single Attribute
Class	0x40A (Hex)
Instance	1
Attribute	0x0C (Hex)
Request Data Length	2 Bytes

Table 3.5. – Remote Target Time Zone Adjust Message Parameters

A. REQUEST DATA:

Parameter	Data Type	Description
Time Zone	INT	The signed number of minutes for the time zone adjustment.

Table 3.6. – Remote Target Time Zone Adjust Request

B. RESPONSE DATA:

Parameter	Data Type	Description
None	-	-

Table 3.7. – Remote Target Time Zone Adjust Response

3.4.5. REMOTE TARGET - LEGACY

The Remote Target - Legacy configuration is shown in the figure below. This configuration window is opened by either double clicking on the module in the tree or right clicking the module followed by selecting *Configuration*. Once in the configuration window select the **Remote Target – Legacy** tab.

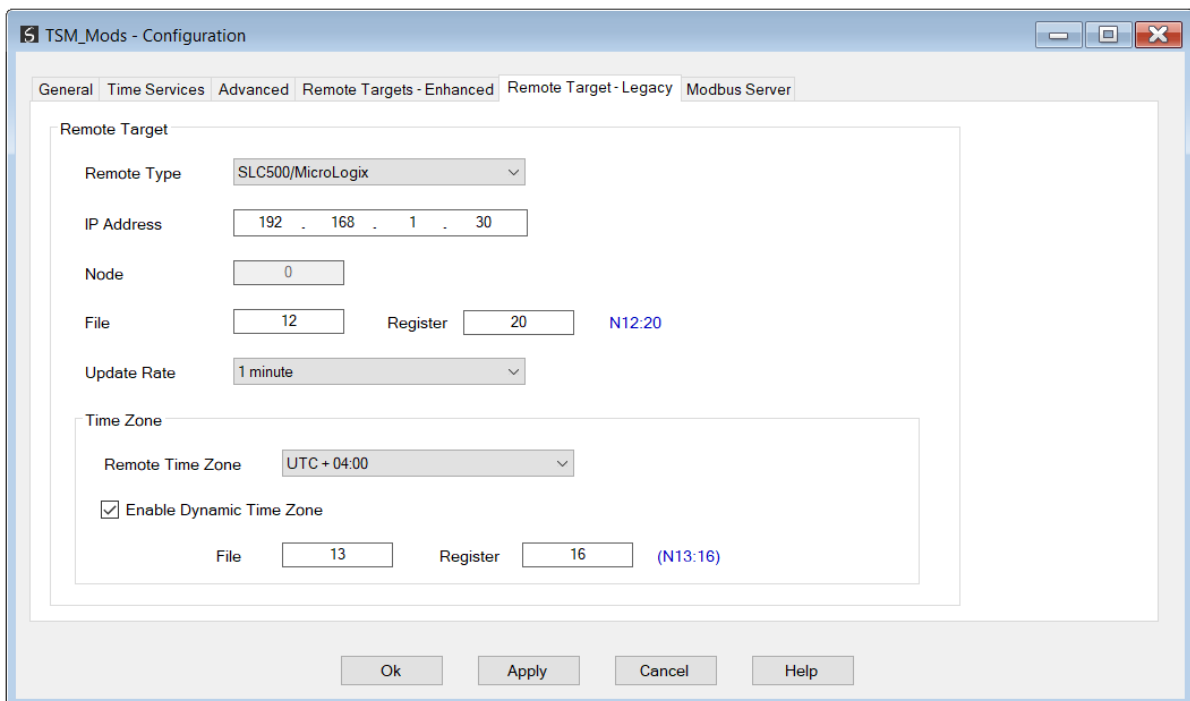

Figure 3.19 – Remote Target configuration

The **Remote Target - Legacy** configuration consists of the following parameters:

Parameter	Description
Remote Type	The remote device type, either: <ul style="list-style-type: none"> • None (Disabled) • PLC5 • SLC500 / MicroLogix • Modbus TCP
IP Address	The IP Address of the remote device.

Node	The Modbus node address. (Only applicable for Modbus TCP.)
File	PLC Data file number. (Only applicable for PLC5, SLC500 and MicroLogix.)
Register	PLC Data register (PLC5, SLC500 and MicroLogix) or Modbus holding register (Modbus TCP)
Update Rate	The rate at which the Time is written to the remote device. Options include: <ul style="list-style-type: none"> • 1 second • 10 seconds • 1 minute • 30 minutes • 1 hour • 6 hours • 12 hours • 24 hours
Remote Time Zone	The time zone of the remote device. This value is added to the UTC time before being written.
Enable Dynamic Time Zone	When this parameter is not selected, then the time zone added to the local module time is the static value selected in the <i>Remote Time Zone</i> parameter. When <i>Enable Dynamic Time Zone</i> is selected, then the time zone used will be read from the Remote Target at the configured PLC File or Modbus Register.
File (TZ)	PLC Data file number where the Time Zone can be found. (Only applicable for PLC5, SLC500 and MicroLogix.). NOTE: The Time zone is a signed value in minutes. For example a value of 120 would indicate a time zone of UTC + 2 (120minutes = 2hours). A value of -180 would indicate a time zone of UTC – 3 (180minutes = 3hours).
Register (TZ)	PLC Data register (PLC5, SLC500 and MicroLogix) or Modbus holding register (Modbus TCP) where the Time Zone can be found. NOTE: The Time zone is a signed value in minutes. For example a value of 120 would indicate a time zone of UTC + 2 (120minutes = 2hours). A value of -180 would indicate a time zone of UTC – 3 (180minutes = 3hours).

Table 3.8. – Remote Target configuration parameters



WARNING: Care must be taken when selecting the remote device and register. Incorrect configuration, and the subsequent module writing to incorrect PLC addresses or Modbus registers, may have unexpected consequences and could result in personal injury and/or equipment damage.

3.4.6. MODBUS SERVER

The Modbus Server configuration is shown in the figure below. The configuration window is opened by either double clicking on the module in the tree or right clicking the module

followed by selecting *Configuration*. Once in the configuration window select the *Modbus Server* tab.

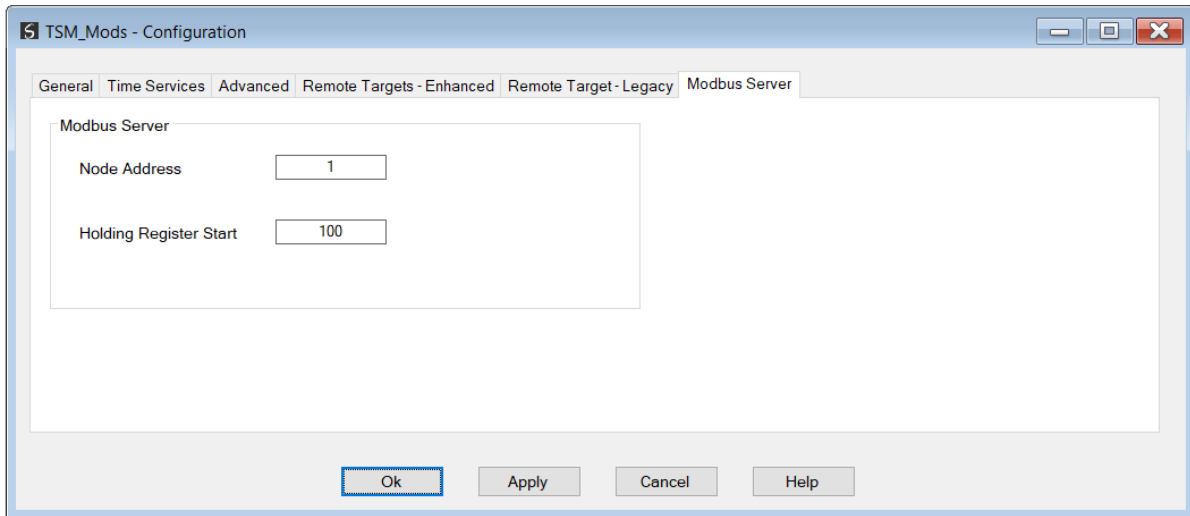

Figure 3.20 – Modbus Server configuration.

The Modbus Server configuration consists of the following parameters:

Parameter	Description
Node Address	The Modbus Node address for the TSM.
Holding Register Start	The Modbus Holding Register address where the data will start. See section 5.5 for the structure of the data.

Table 3.9. – Modbus Server configuration parameters.

3.5. MODULE DOWNLOAD

Once the Time Sync configuration has been completed, it must be downloaded to the module.

Before downloading the Connection Path of the module should be set. This path will automatically default to the IP address of the module, as set in the module configuration. It can however be modified, if the Time Sync module is not on a local network.

The Connection path can be set by right-clicking on the module and selecting the Connection Path option.

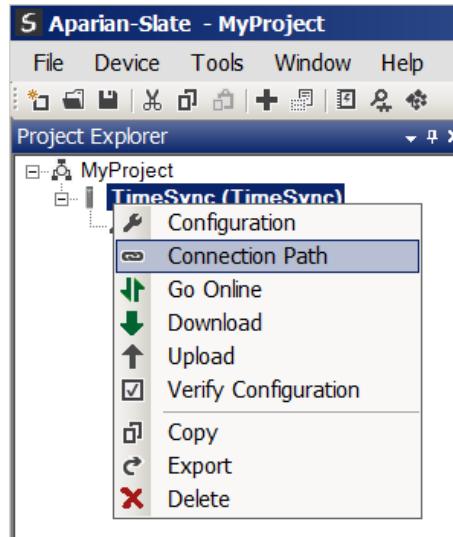

Figure 3.21. - Selecting Connection Path.

The new connection path can then be either entered manually or selected by means of the Target Browser.

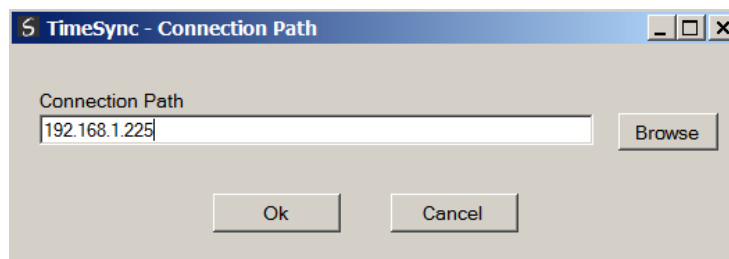

Figure 3.22. - Connection Path.

To initiate the download, right-click on the module and select the Download option.

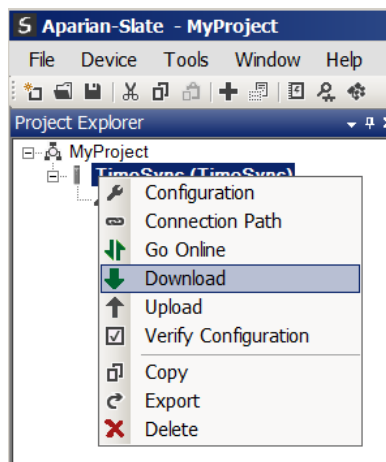

Figure 3.23. - Selecting Download.

Once complete, the user will be notified that the download was successful.

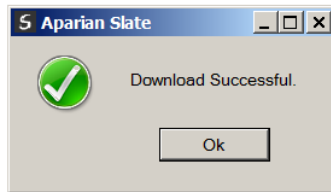

Figure 3.24. - Successful download.

Within the Slate environment the module will be in the Online state, indicated by the green circle around the module.

The module is now configured and will start operating immediately.

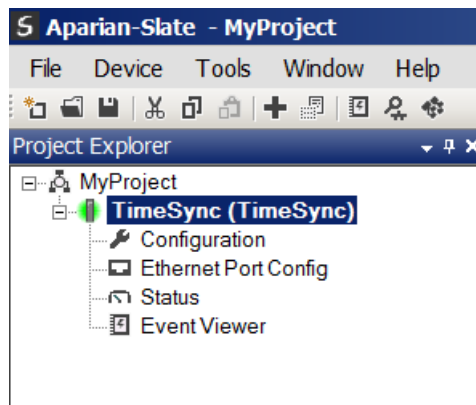

Figure 3.25. - Module online.

3.6. LOGIX INTEGRATION

The Time Sync modules can be easily integrated with Allen-Bradley Logix family of controllers. For Logix versions 20 and beyond, the modules can be added using the EDS Add-On-Profile (AOP), which is described in section 3.6.2.

For older versions (19 and below), the module must be added using a Generic Profile which is described in section 3.6.1.

3.6.1. RSLOGIX 5000 CONFIGURATION (PRE-VERSION 20)

3.6.1.1. ADD MODULE TO I/O CONFIGURATION

The module can operate in either a Logix “owned” or standalone mode. When the module operates in a Logix “owned” mode the Time Sync module will need to be added to the RSLogix 5000 I/O tree. The module will need to be added as a generic Ethernet module. This is achieved by right clicking on the Ethernet Bridge in the RSLogix 5000 and selecting *New Module* after which the *ETHERNET-MODULE* is selected to be added as shown in the figure below.



NOTE: See the next section for importing the configuration (L5X).

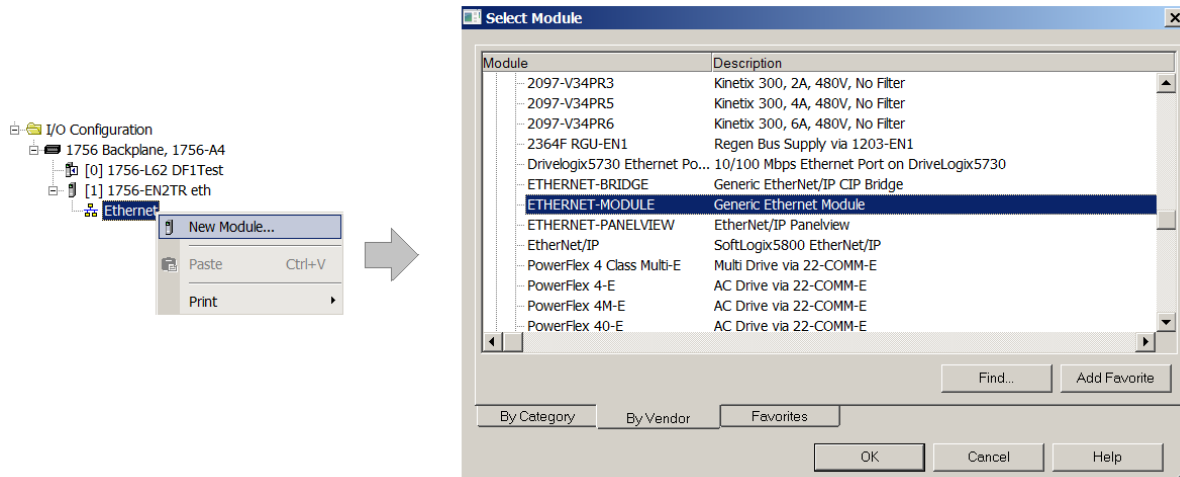

Figure 3.26 - Add a Generic Ethernet Module in RSLogix 5000.

The user must enter the IP address of the Time Sync module that will be used. The assembly instance and size must also be added for the input, output, and configuration in the connection parameters section. Below are the required connection parameters.

Connection Parameter	Assembly Instance	Size
Input	105	53 (32-bit)
Output	106	3 (32-bit)
Configuration	102	0 (8-bit)

Table 3.10. - RSLogix class 1 connection parameters for the Time Sync module

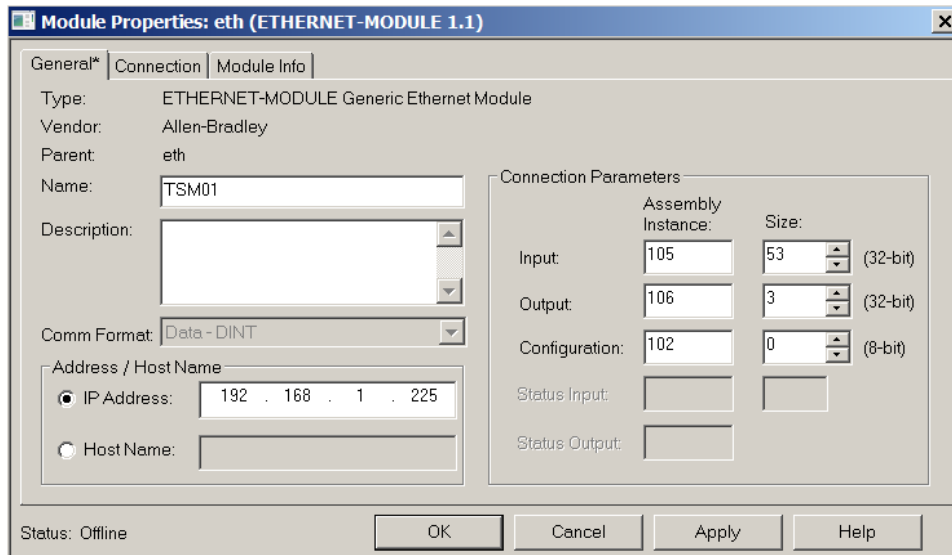

Figure 3.27 - RSLogix General module properties in RSLogix 5000.



NOTE: The user will need to enter the exact connection parameters before the module will establish a class 1 connection with the Logix controller.

Next the user needs to add the connection requested packet interval (RPI). This is the rate at which the input and output assemblies are exchanged. The recommended value is 200ms. Refer to the technical specification section in this document for further details on the limits of the RPI.



NOTE: Although the module is capable of running with an RPI of 1ms, it is recommended to set the RPI to 200ms, to avoid unnecessary loading of the module processor.

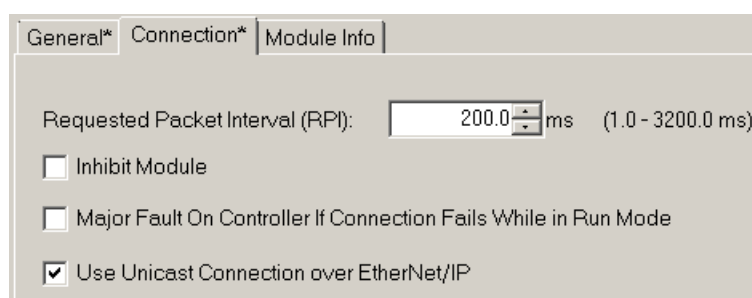

Figure 3.28 - Connection module properties in RSLogix 5000.

Once the module has been added to the RSLogix 5000 I/O tree the user must assign the User Defined Types (UDTs) to the input and output assemblies. The user can import the required UDTs by right-clicking on *User-Defined* sub-folder in the *Data Types* folder of the I/O tree and selecting *Import Data Type*. The assemblies are then assigned to the UDTs with a ladder copy instruction (COP) as shown in the figure below.

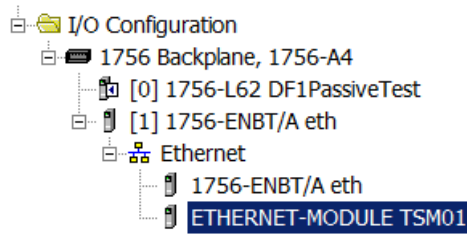

Figure 3.29 – RSLogix 5000 I/O module tree.

3.6.1.2. IMPORTING UDTS AND MAPPING ROUTINES

To simplify the mapping of the input image, an RSLogix 5000 Routine Partial Import (L5X) file is provided.

This file can be imported by right-clicking on the required Program and selecting the Import Routine option.

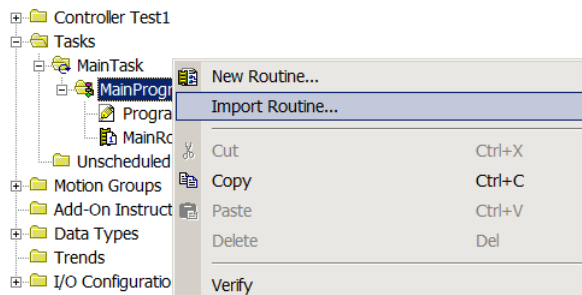

Figure 3.30. – RSLogix 5000 Importing Time Sync specific routine and UDts.

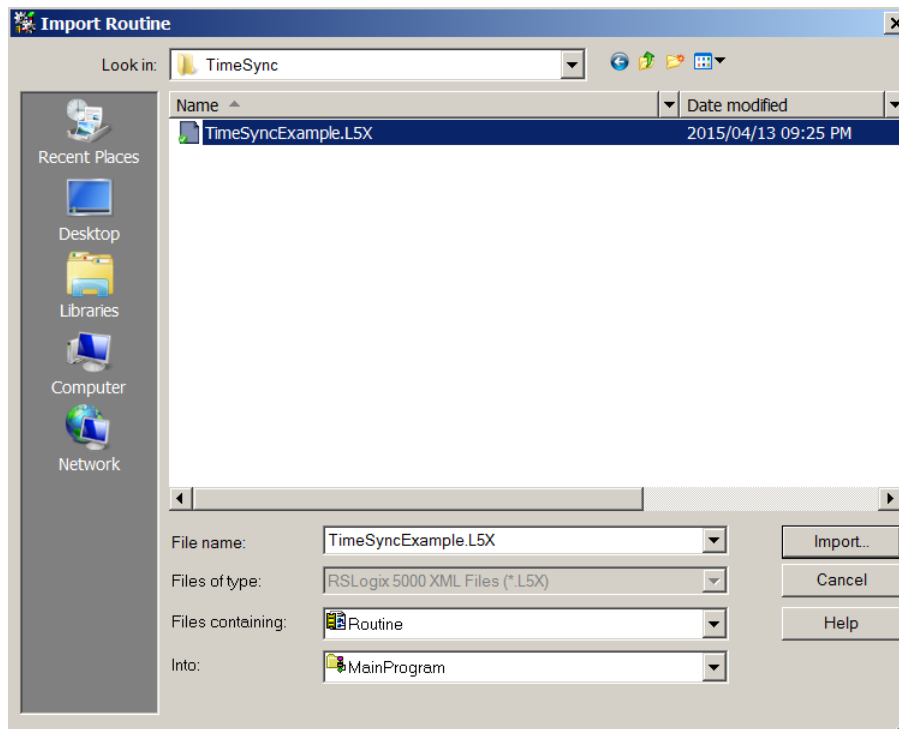

Figure 3.31. - Selecting partial import file.

The import will create the following:

- The required UDTs (user defined data types)
- Two controller tags representing the Input and Output assemblies.
- A routine mapping the Time Sync module to the aforementioned tags.
- An example of how to reset the odometer.

The user may need to change the routine to map to the correct Time Sync module instance name, and make sure that the mapping routine is called by the Program's Main Routine.

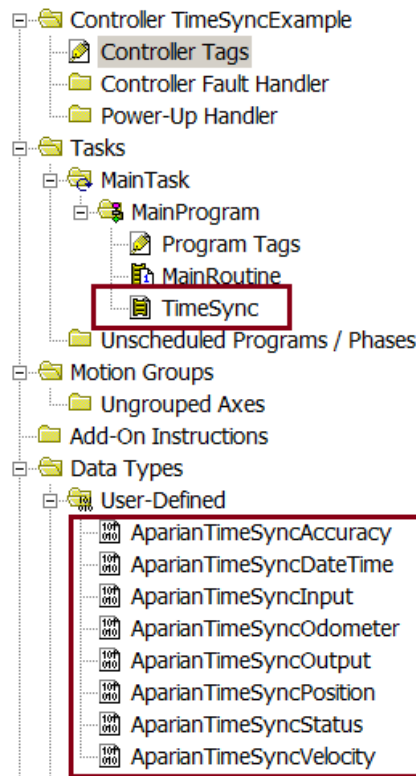

Figure 3.32. - Imported RSLogix 5000 objects.

Refer to the additional information section of this document for an example RSLogix 5000 project as well as the required UDTs.

3.6.2. STUDIO 5000 CONFIGURATION (VERSION 20+)

Integration with the Logix family in Studio5000 makes use of the EDS AOP. Before the module can be added to the tree the module's EDS file must be registered. Using RSLinx, the EDS file can be uploaded from the device after which the EDS Hardware Installation tool will be invoked to complete the registration.

Alternatively, the EDS file can be downloaded from the product web page at <https://www.aparian.com/products/timesync#downloads> and registered manually using the EDS Hardware Installation Tool shortcut under the Tools menu in Studio 5000.

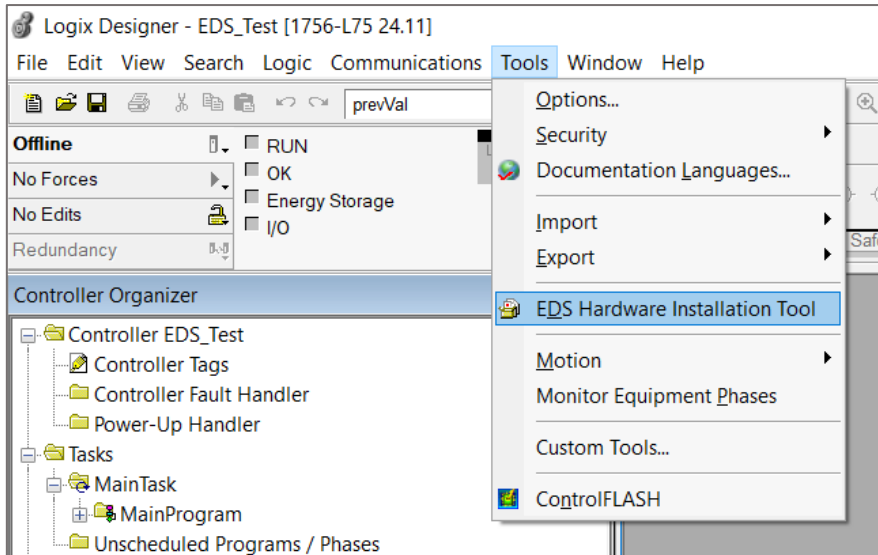

Figure 3.33. - EDS Hardware Installation Tool.

After the EDS file has been registered, the module can be added to the Logix IO tree in Studio 5000. Under a suitable Ethernet bridge module in the tree, select the Ethernet network, right-click and select the New Module option.

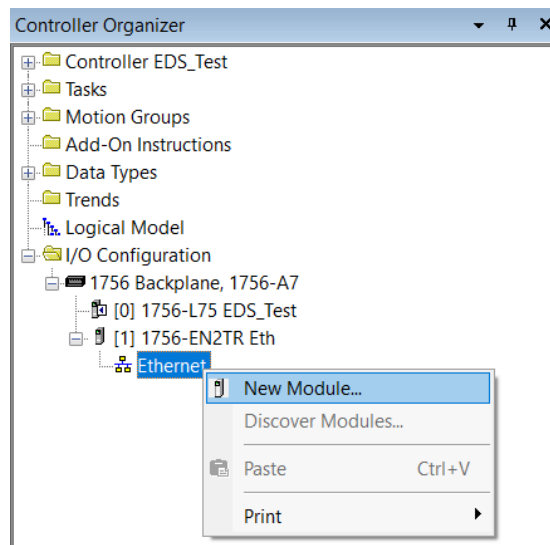

Figure 3.34. – Adding a module.

The module selection dialog will open. To find the module more easily, use the Vendor filter to select only the Aparian modules as shown in the figure below.

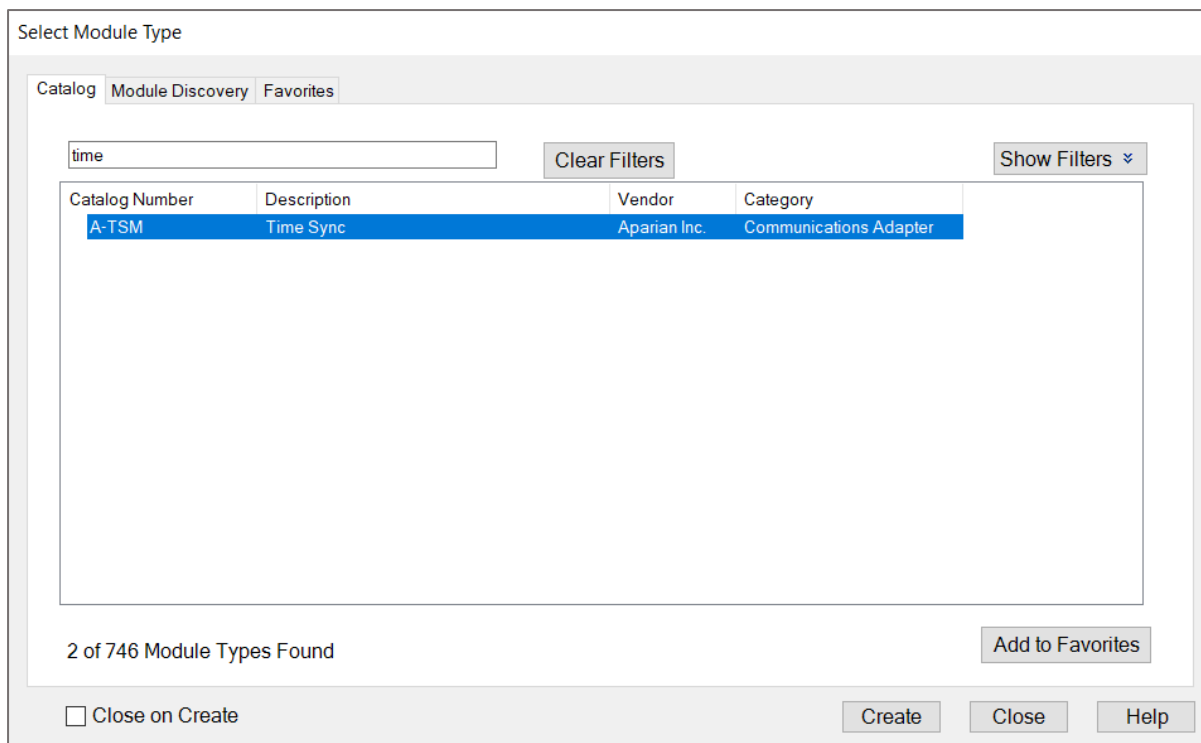

Figure 3.35. – Selecting the module.

Locate and select the Time Sync module and select the **Create** option. The module configuration dialog will open, where the user must specify the Name and IP address as a minimum to complete the instantiation.

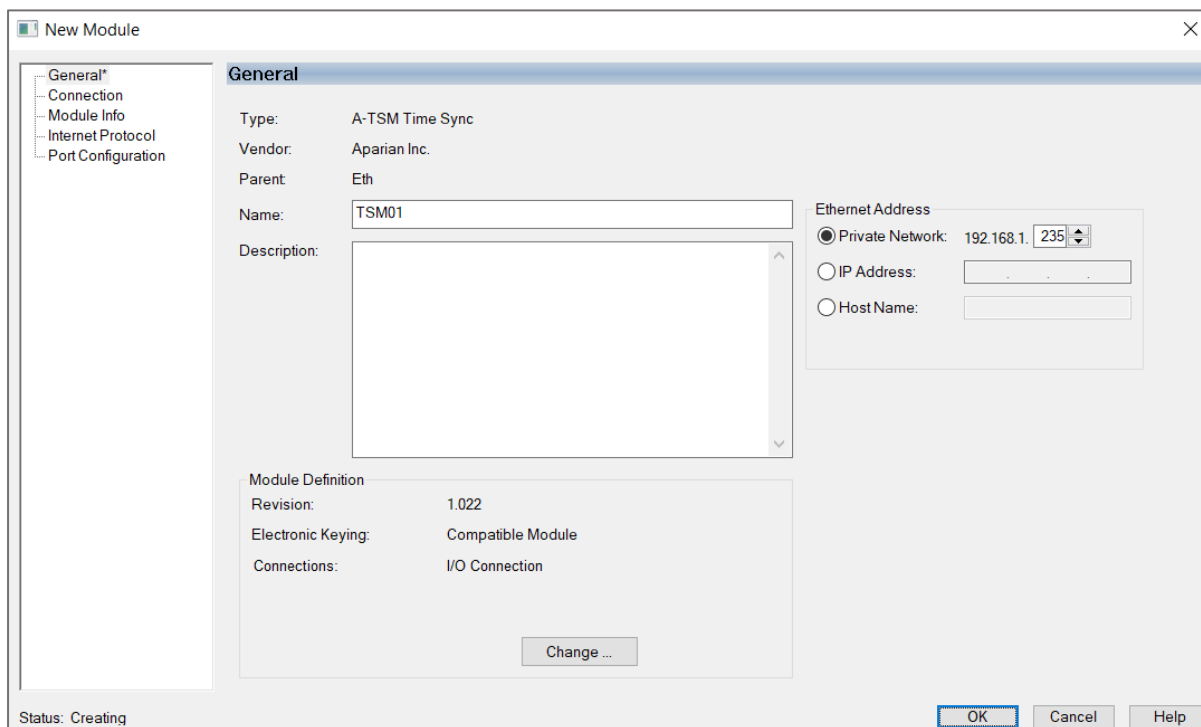

Figure 3.36. – Module instantiation.

Once the instantiation is complete the module will appear in the Logix IO tree.

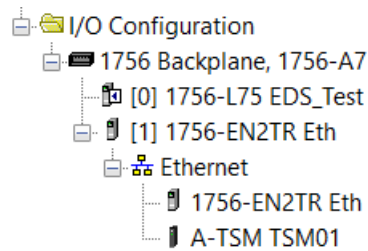

Figure 3.37. – Logix IO tree.

The Module Defined Data Types will automatically be created during the instantiation process. These data types provide meaningful structures to the module data. An excerpt of the Input Image is shown in the following figure.

Name	Value	For	Style	Data Type
TSM01:I	{...}	{...}		_055A:A_TSM_5E0DA793:I:0
TSM01:I.ConnectionFaulted	0		Decimal	BOOL
TSM01:I.InstanceNameLength	0		Decimal	DINT
TSM01:I.Status	2#0000_0000_00...		Binary	DINT
TSM01:I.ConfigurationValid	0		Decimal	BOOL
TSM01:I.PtpEnabled	0		Decimal	BOOL
TSM01:I.NtpEnabled	0		Decimal	BOOL
TSM01:I.AntennaShort	0		Decimal	BOOL
TSM01:I.Fix2D	0		Decimal	BOOL
TSM01:I.Fix3D	0		Decimal	BOOL
TSM01:I.FixAutonomous	0		Decimal	BOOL
TSM01:I.FixDifferential	0		Decimal	BOOL
TSM01:I.NTPSource1Connected	0		Decimal	BOOL
TSM01:I.NTPSource2Connected	0		Decimal	BOOL
TSM01:I.IsPtpGrandMaster	0		Decimal	BOOL
TSM01:I.GpsSpoofingDetected	0		Decimal	BOOL
TSM01:I.InterferenceIndication	0.0		Float	REAL
TSM01:I.SatelliteCount	0		Decimal	SINT
TSM01:I.UTC_0	0		Decimal	DINT
TSM01:I.UTC_1	0		Decimal	DINT
TSM01:I.DTYear	0		Decimal	INT
TSM01:I.DTMonth	0		Decimal	SINT
TSM01:I.DTDay	0		Decimal	SINT
TSM01:I.DTHour	0		Decimal	SINT
TSM01:I.DTMinute	0		Decimal	SINT
TSM01:I.DTSecond	0		Decimal	SINT
TSM01:I.DTNanoSecond	0		Decimal	DINT
TSM01:I.VelTrueCourseOverGround	0.0		Float	REAL

Figure 3.38. – Module Defined Data Type.

3.7. PC SETUP FOR NTP

Personal computers and servers can be setup to synchronize their clocks to the Time Sync module using Microsoft Windows Time Service. To configure the time source the user must left click on the clock at the bottom right of the taskbar as shown below and select *Change Date and Time settings*:

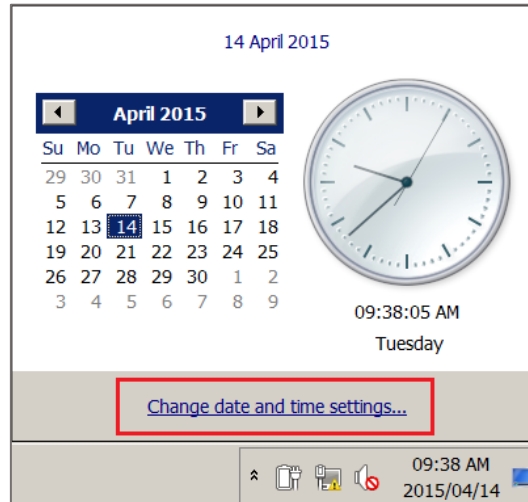

Figure 3.39. – Opening the windows date and time settings.

Next the user must select *Change settings* in the Internet Time tab as shown below:

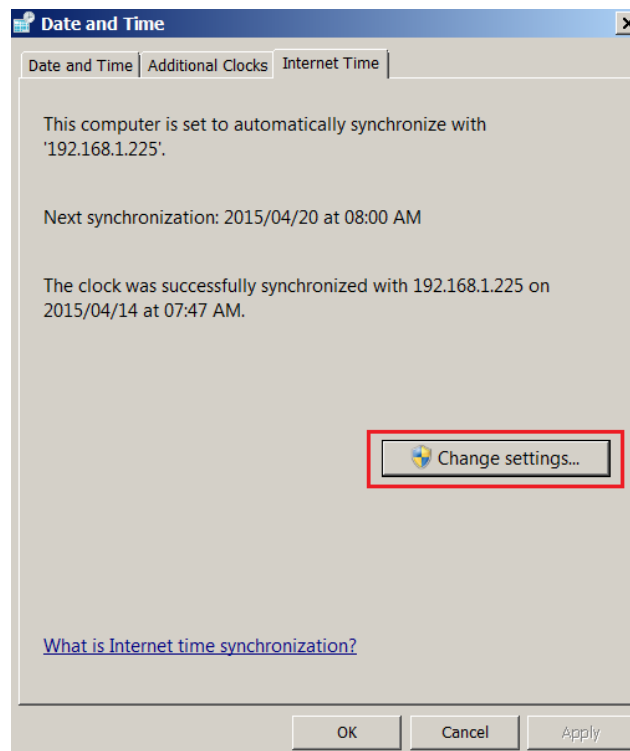

Figure 3.40. – Changing Windows time settings.

The IP address of the Time Sync module must be entered here to enable Windows to synchronize to the Time Sync module using NTP as shown below. To ensure that the synchronization is operating as intended the user can press Update now to test the connection.

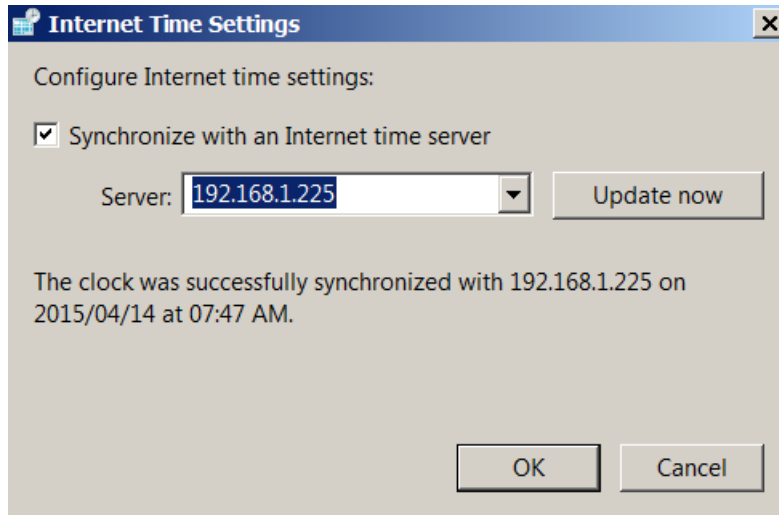

Figure 3.41. – Entering the new time server IP address.



NOTE: The user might originally need to press the **Update Now** a few times as the Windows Time Service changes servers.

3.8. LOGIX TIME SYNCHRONIZATION SETUP

Once the Time Sync module has been setup and the user is planning to use 1588 PTP for time synchronization and a Logix system is being used, then certain module will need to be setup for Time Synchronization.

3.8.1. LOGIX SETUP

If the Logix rack setup is using an Ethernet bridge (e.g., 1756-EN2TR) to synchronize the backplane to the 1588 PTP Ethernet network, then the *Time Sync and Motion* option needs to be enabled on the Ethernet bridge (as shown below). The Logix controller must also have the *Enable Time Synchronize* set to enable the Logix controller to synchronize to the 1588 PTP Master (as shown below).

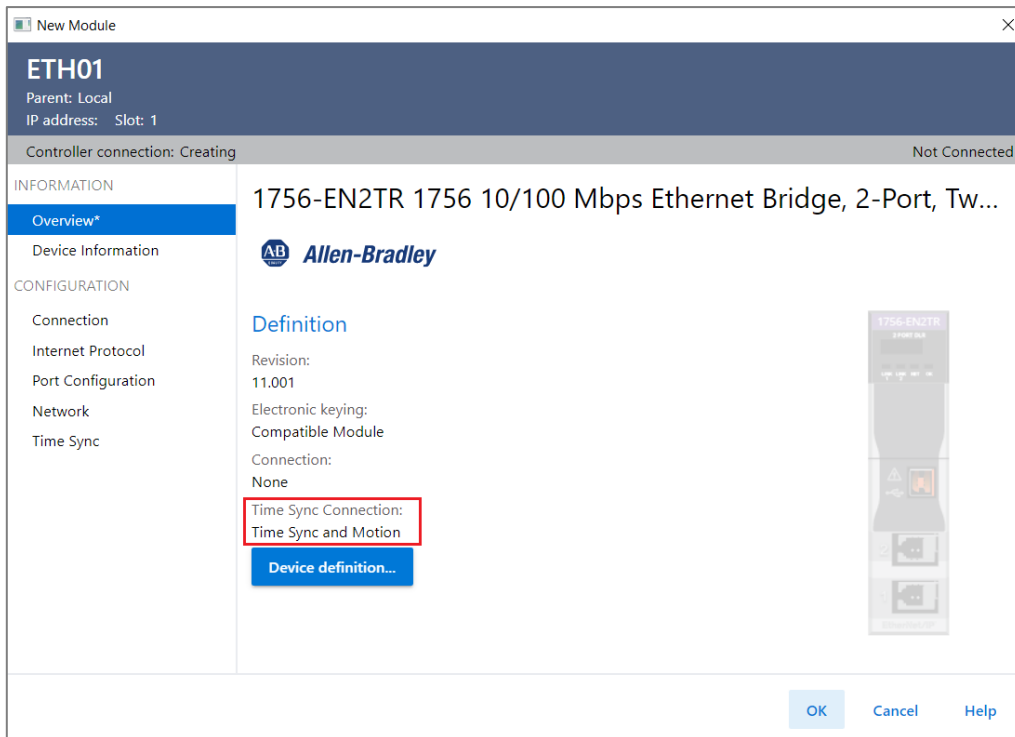

Figure 3.42. – Ethernet Bridge Time Sync Connection.

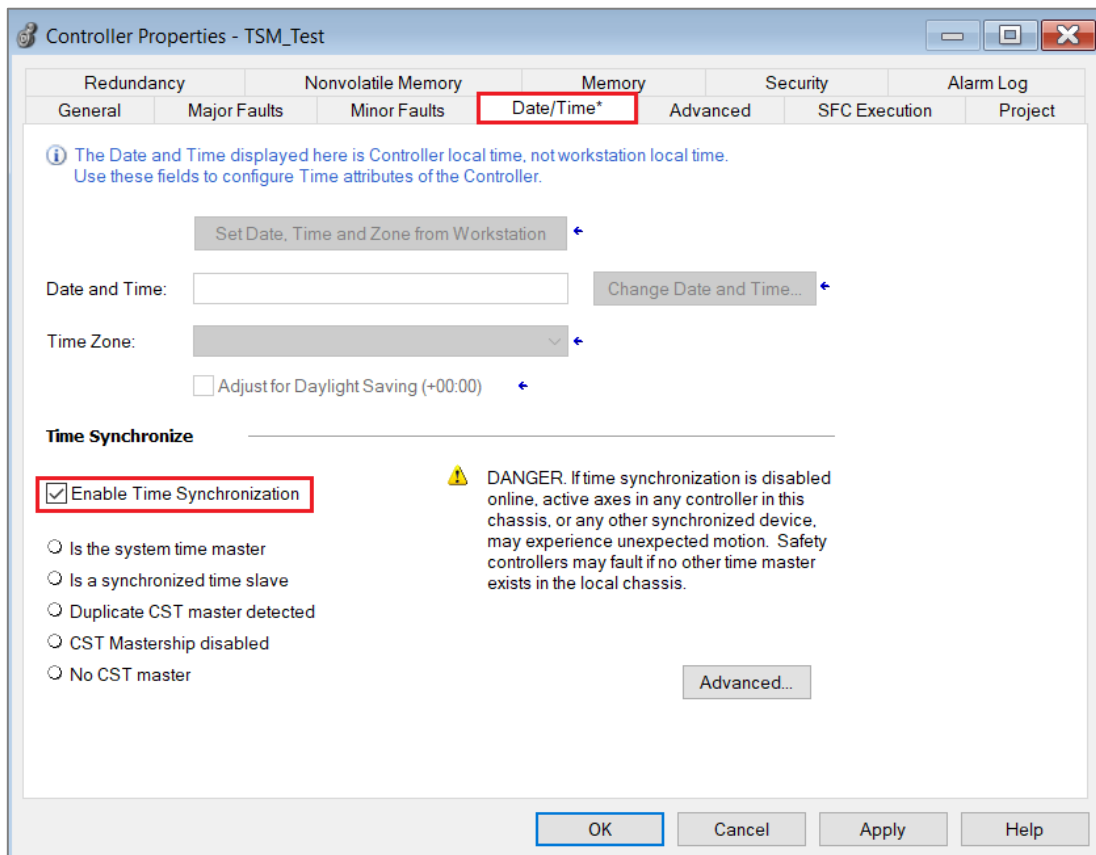

Figure 3.43. – Logix Controller Time Synchronization Enable.

4. DEVICE FIRMWARE UPDATE

The TSM module supports in-field firmware upgrading. The latest firmware for the module can be downloaded from the Aparian website www.aparian.com. The firmware is digitally signed, so only the correct firmware can be used.

To firmware upgrade the module, follow the steps below:

- From the **Tools** menu in Slate, select the **DeviceFlash** utility.

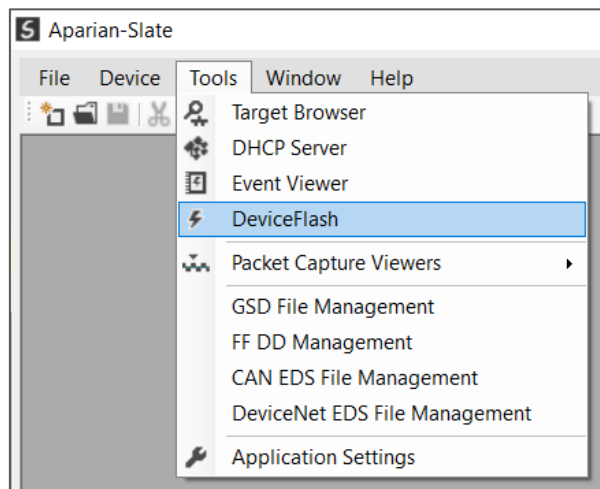

Figure 4.1 – Select DeviceFlash utility from Slate.

- When the utility opens, the user will be prompted to select the binary file to be used to firmware upgrade the module.

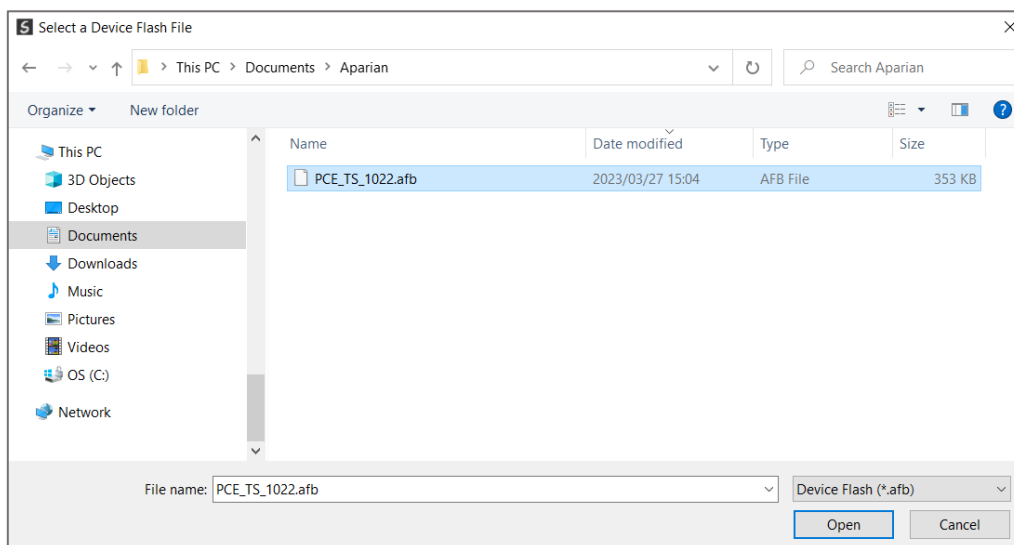

Figure 4.2 – Select the binary file.

- After selecting the file, the user will be prompted to select the device to firmware upgrade on the local network.

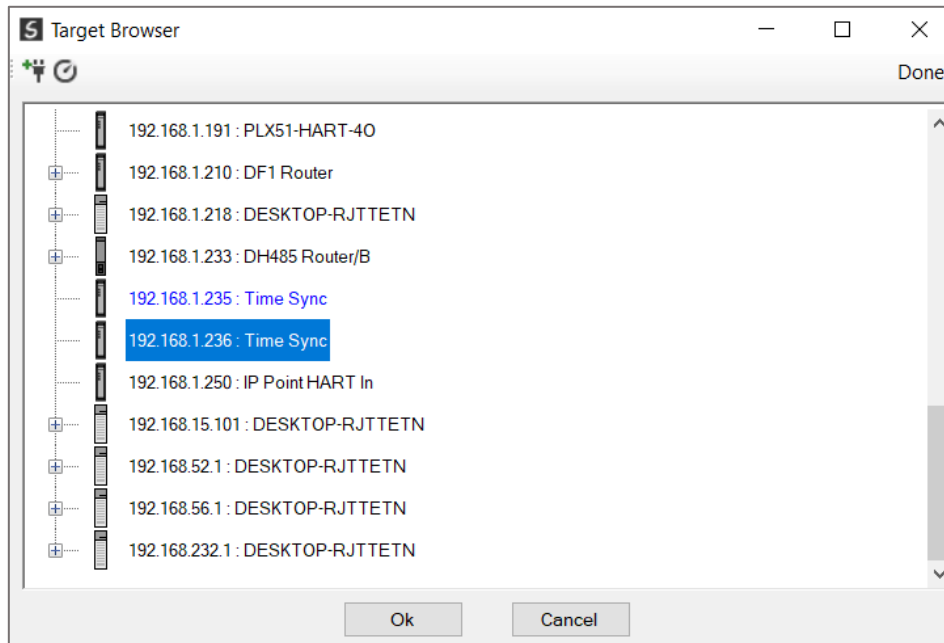

Figure 4.3 – Select the device to be updated.

- After the device selection the user will be prompted if the device flash must start. The firmware update will take less than 2 minutes to complete.

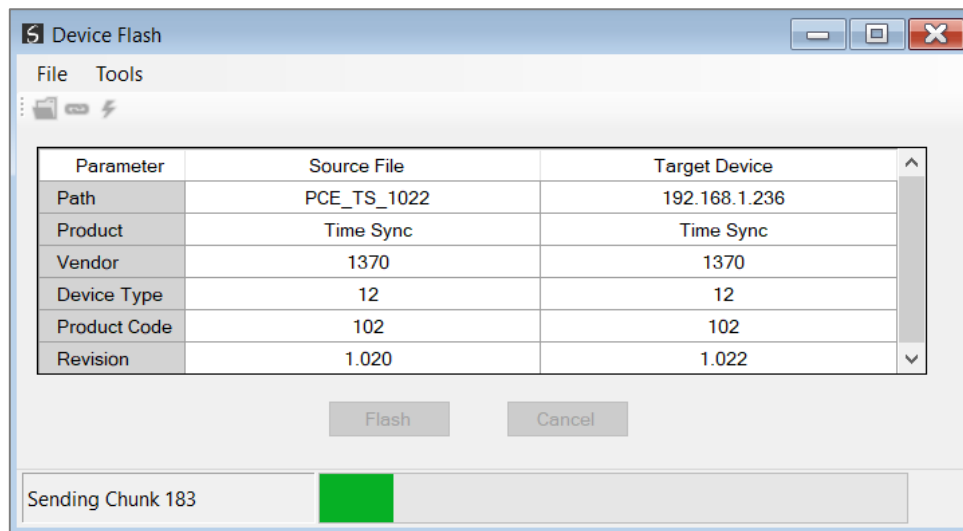

Figure 4.4 – Firmware update busy.

- Once the firmware update has successfully completed, the Target Device textboxes will display green.

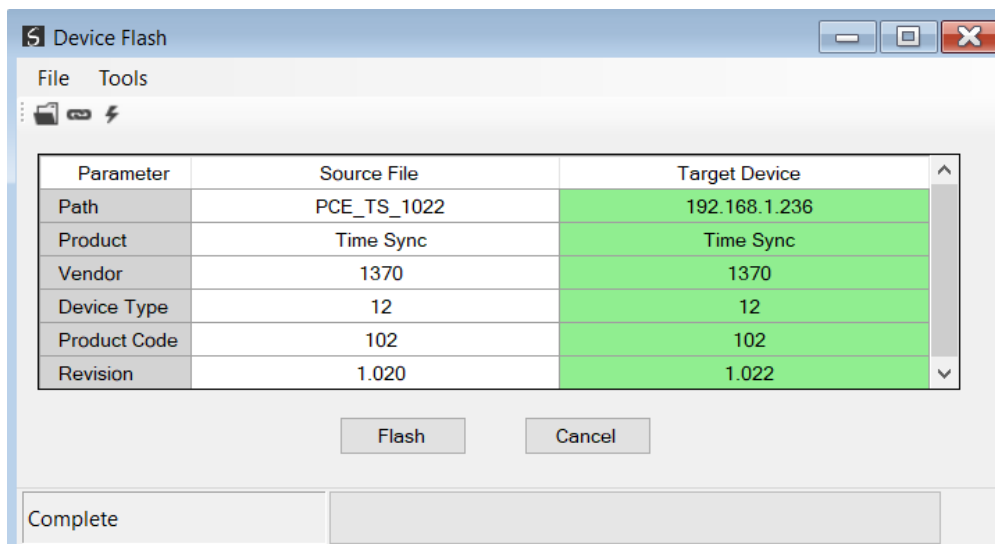

Figure 4.5 – Firmware update successfully completed.



NOTE: If for any reason the firmware update failed (e.g. power down during the update), then the module will revert back to the bootloader. The user can then simply reflash the module again to update it to the latest application firmware.

5. OPERATION

5.1. TIME SYNCHRONIZATION

The preferred method of accurate time synchronization is achieved using 1588 PTP over an Ethernet network. The accuracy of the time synchronization is dependent on the Ethernet switching equipment, network architecture, boundary clocks, and end devices.

Switches that are PTP enabled will allow for the best accuracy timing results as the randomness in the delay between packets being sent from and to the Time Sync module is at the lowest possible level. Switches that are not PTP enabled or are of lower quality can result in large random delays between switching packets which results in lower quality time synchronization. When the Time Sync module is directly connected to a PTP enabled end device with a good quality GPS fix, time error can be as low as 100ns. The more Ethernet switches between the master clock (Time Sync module) and the end device the larger the random delays the less accurate the time will be.

The user also has the ability to change various PTP parameters using the CIPSync communication object. These values can be changed in Slate under the CIPSync tab of the Status window when online. This is shown below:

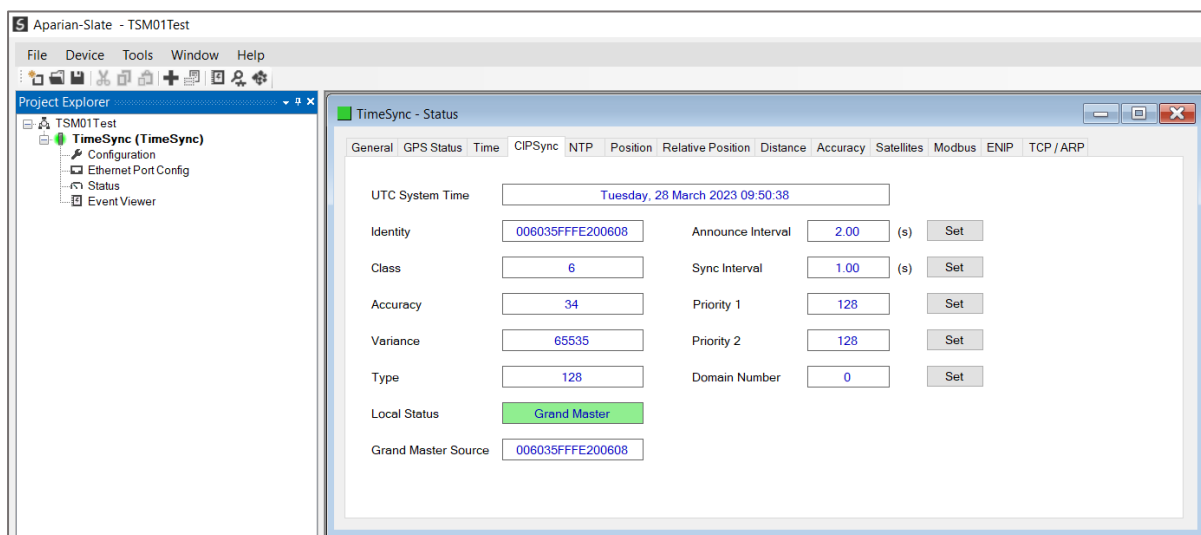

Figure 5.1. – CIPSync parameters.



NOTE: It is recommended that the user do not change these values unless it is required as it can result in non-ideal timing performance depending on the network architecture.



NOTE: For further information regarding the announce interval, sync interval, priority 1, priority 2, and domain number refer to the additional information section 1.4 under CIP Sync and 1588 PTP.

Switches and network architecture can also affect the time synchronization accuracy when using NTP. Thus, the closer the Time Sync module to the end device the better the time accuracy between the clock master and client. The PC time is generally only accurate to about 10ms when using NTP (RFC1305). Once the module has been enabled to support NTP using Slate there is no further configuration required.

The Gregorian date and time (Year, Day, Month etc.) as well as the raw UTC time is provided in Slate as well as the input assembly of the module (see section 4.4.1).

5.1.1. SOURCE: GPS – OUTPUT: 1588 PTP

When the time source is setup for GPS / PTP (as shown below), then the TSM will use either the GPS receiver or the 1588 PTP network to synchronize it’s time. When the TSM has GPS lock, then it will always use the GPS receiver to synchronize it’s local time. When GPS lock is lost (e.g., the GPS antenna is unplugged or something is blocking the GPS antenna view of the sky), then the TSM will only use another PTP source if the clock quality is better than its own.

When the *Enable PTP* option is set, then the TSM will attempt to become the 1588 PTP Grand Master on the Ethernet network, to which all other PTP device will synchronize.

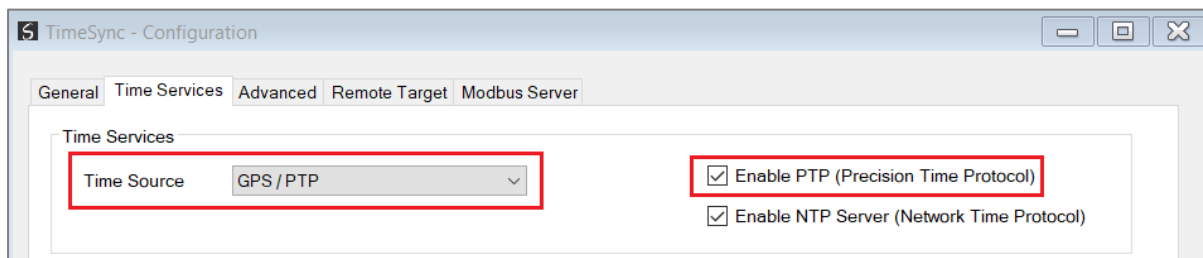

Figure 5.2. – Source: GPS – Output: 1588 PTP.

5.1.2. SOURCE: NTP CLIENT – OUTPUT: 1588 PTP

When the time source is setup for NTP Client or NTP Symmetric (as shown below), then the TSM will use the time from the NTP Server to synchronize it’s time.

When the *Enable PTP* option is set, then the TSM will attempt to become the 1588 PTP Grand Master on the Ethernet network, to which all other PTP device will synchronize.

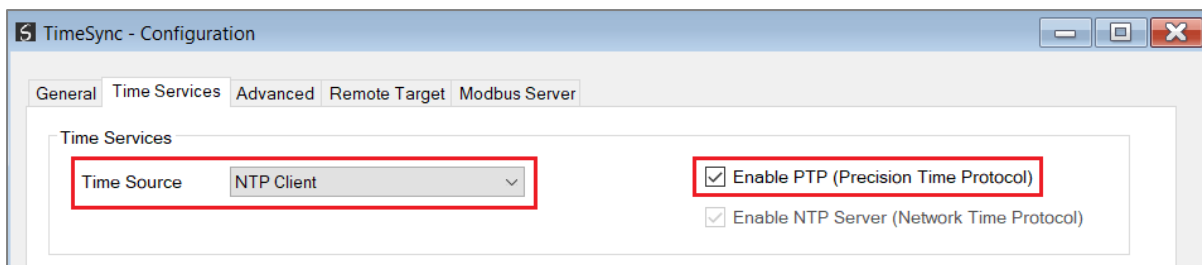

Figure 5.3. – Source: NTP – Output: 1588 PTP.

5.1.3. SOURCE : GPS – OUTPUT: NTP SERVER

When the time source is setup for GPS / PTP (as shown below), then the TSM will use either the GPS receiver or the 1588 PTP network to synchronize it’s time. When the TSM has GPS lock, then it will always use the GPS receiver to synchronize it’s local time. When GPS lock is lost (e.g., the GPS antenna is unplugged or something is blocking the GPS antenna view of the sky), then the TSM will only use another PTP source if the clock quality is better than its own.

When the *Enable NTP* option is set, then the TSM will operate as a NTP Server to which NTP Clients can connect and synchronize their time.

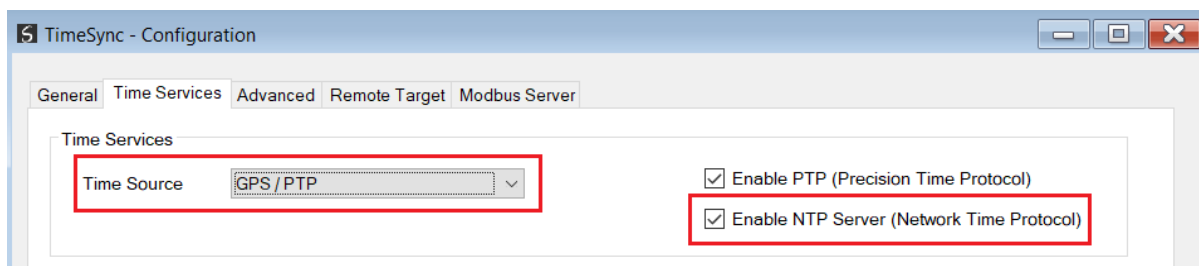

Figure 5.4. – Source: GPS – Output: NTP.

5.1.4. SOURCE: 1588 PTP – OUTPUT: NTP SERVER

When the time source is setup for GPS / PTP (as shown below), then the TSM will use either the GPS receiver or the 1588 PTP network to synchronize it’s time. If the GPS antenna is removed and GPS lock is lost then the TSM will only use another PTP source if the clock quality is better than its own.

When the *Enable NTP* option is set, then the TSM will operate as a NTP Server to which NTP Clients can connect and synchronize their time.

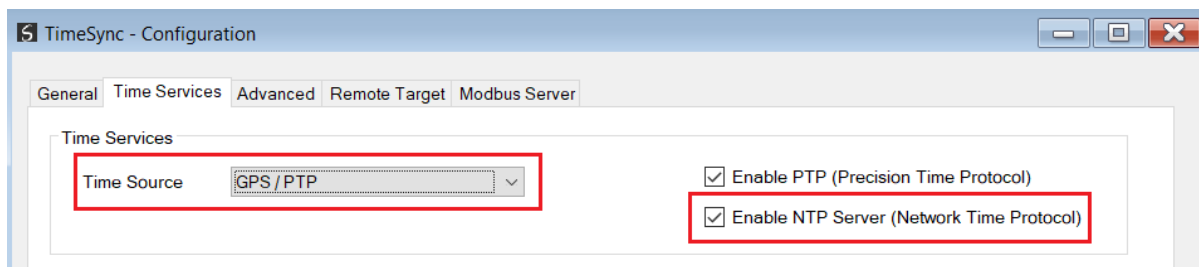

Figure 5.5. – Source: GPS – Output: NTP.

5.1.5. LEGACY – REMOTE TARGET

5.1.5.1. SET TIME

The Remote Target functionality provides a method to update the time of one of the following devices:

- Allen-Bradley PLC5
- Allen-Bradley SLC500
- Allen-Bradley MicroLogix (non-1400)
- Allen-Bradley MicroLogix 1400
- Allen-Bradley Micro800 (EtherNet/IP versions)
- Modbus TCP Server device

Irrespective of the choice of the device, the time is always written as 6 (16bit) integers as follows:

Address	Datatype	Description
Register	INT	Year in YYYY format, e.g. 2016
Register + 1	INT	Month
Register + 2	INT	Day
Register + 3	INT	Hour
Register + 4	INT	Minute
Register + 5	INT	Second

Table 5.1. – Remote Target date-time data format.

This format allows the time to be written directly to the system time of the PLC / SLC, as follows:

- PLC5: **S2:18**
- SLC500/MicroLogix: **S2:37**

Alternatively, the date-time can be written to an N file, and then subsequently copied to the status file using ladder logic.

5.1.5.2. TIME ZONE READ

When *Enable Dynamic Time Zone* is set, then the TSM will attempt to read the time zone from the remote target before the time is updated in the remote target. The format of the time zone (for SLC, PLC5, and Modbus device) is a signed 16-bit integer with the units being minutes.

For example a value of 120 would indicate a time zone of UTC + 2 (120minutes = 2hours). A value of -180 would indicate a time zone of UTC – 3 (180minutes = 3hours).

5.2. POSITIONING

The module provides position information that can either be used in its raw format as well as a relative format. The module provides Latitude, Longitude, and Altitude (LLA) information in its raw format in the input assembly (see section 4.4.1).

The position can also be output in a relative LLA position. This affords better accuracy in the input assembly by avoiding the errors associated with single floating-point math. The user can enter the reference LLA position into the output assembly of the module which will be subtracted from the raw LLA data, (using double floating-point math,) providing LLA that is relative to the reference position as shown below:

[-] ts_input.Position	{...}	{...}		AparianTimeSy...
[-] ts_input.Position.Latitude	-26.10634		Float	REAL
[-] ts_input.Position.Longitude	28.002226		Float	REAL
[-] ts_input.Position.Altitude	1608.9		Float	REAL
[-] ts_input.Position.ReferenceLatitude	0.0		Float	REAL
[-] ts_input.Position.ReferenceLongitude	0.0		Float	REAL
[-] ts_input.Position.ReferenceAltitude	0.0		Float	REAL
[-] ts_input.Position.RelativeLatitude	-26.106339		Float	REAL
[-] ts_input.Position.RelativeLongitude	28.002224		Float	REAL
[-] ts_input.Position.RelativeAltitude	1608.9		Float	REAL
[-] ts_input.Position.RelativeNorth	2661743.0		Float	REAL
[-] ts_input.Position.RelativeEast	-3216551.3		Float	REAL
[+] ts_input.Odometer	{...}	{...}		AparianTimeSy...
[+] ts_input.Accuracy	{...}	{...}		AparianTimeSy...
[-] ts_output	{...}	{...}		AparianTimeSy...
[-] ts_output.ReferenceLatitude	0.0		Float	REAL
[-] ts_output.ReferenceLongitude	0.0		Float	REAL
[-] ts_output.ReferenceAltitude	0.0		Float	REAL

Figure 5.6. – Relative position with no reference position.

[-] ts_input.Position	{...}	{...}		AparianTimeSy...
[-] ts_input.Position.Latitude	-26.106316		Float	REAL
[-] ts_input.Position.Longitude	28.002222		Float	REAL
[-] ts_input.Position.Altitude	1606.2		Float	REAL
[-] ts_input.Position.ReferenceLatitude	-26.108511		Float	REAL
[-] ts_input.Position.ReferenceLongitude	28.006868		Float	REAL
[-] ts_input.Position.ReferenceAltitude	1600.0		Float	REAL
[-] ts_input.Position.RelativeLatitude	2.19713780e-003		Float	REAL
[-] ts_input.Position.RelativeLongitude	-0.004645029		Float	REAL
[-] ts_input.Position.RelativeAltitude	6.2		Float	REAL
[-] ts_input.Position.RelativeNorth	-244.31885		Float	REAL
[-] ts_input.Position.RelativeEast	463.80078		Float	REAL
[+] ts_input.Odometer	{...}	{...}		AparianTimeSy...
[+] ts_input.Accuracy	{...}	{...}		AparianTimeSy...
[-] ts_output	{...}	{...}		AparianTimeSy...
[-] ts_output.ReferenceLatitude	-26.108511		Float	REAL
[-] ts_output.ReferenceLongitude	28.006868		Float	REAL
[-] ts_output.ReferenceAltitude	1600.0		Float	REAL

Figure 5.7. – Relative position with reference position.

In addition to the relative LLA position the module also provides a relative North and relative East position for the given reference. These values are given in meters from the reference point and simplify the application logic required for equipment positioning and collision avoidance systems.

5.3. VELOCITY & ODOMETER

The module provides velocity and an odometer reading making it ideal for vehicle and tracking solutions. The velocity is provided in knots as well as kilometres per hour (km/h). The true course over ground is the direction which the Time Sync module’s antenna is moving in. This is measured in degrees from True North.

The odometer provides the distance travelled since it was reset as well as a total distance travelled. The odometer can be reset from either Slate or the RSLogix 5000 environment by using a message instruction. Refer to the example code for the resetting of the odometer. Depending on the speed profile selected in the General configuration of the module different filters and algorithms will be applied to provide the best accuracy distance measurement.



5.4. RSLOGIX / STUDIO 5000 ASSEMBLIES



When the module operates in a Logix “owned” mode the Logix controller will establish a class 1 cyclic communication connection with the Time Sync module. An input and output assembly is exchanged at a fix interval. The UDTs provided will convert the input and output arrays into

tag based assemblies. Refer to the additional information section in this document for the input and output UDTs.

5.4.1. INPUT ASSEMBLY

The following parameters are used in the input assembly of the module.

Parameter	Datatype	Description
Instance	STRING	This parameter is the instance name of the module that was configured under the general Time Sync configuration in Slate.
Status.ConfigValid	BOOL	Set if a valid configuration is executing in the module.
Status.PTPEnabled	BOOL	Set if PTP has been enabled in the module.
Status.NTPEnabled	BOOL	Set if NTP has been enabled in the module.
Status.AntennaShort	BOOL	Set if a short was detected on the antenna.  NOTE: Once a short was detected it will take at least a minute before the fault will be indicated as cleared even if the short was removed immediately.
Status.Fix2D	BOOL	Set if the GPS receiver has obtained a 2-dimensional fix
Status.Fix3D	BOOL	Set if the GPS receiver has obtained a 3-dimensional fix
Status.FixAutonomous	BOOL	Set if the GPS receiver has obtained autonomous fix. This bit can be used to determine if the module has sufficient satellites to provide accurate time and position information.
Status.FixDifferential	BOOL	Set if the GPS receiver has obtained differential fix. This will only be possible if the differential satellite constellation has been enabled (i.e. SBAS). When the module is set into position mode the SBAS constellation is automatically enabled. In time mode it is disabled. WAAS (North America) and EGNOS (Europe) are examples of SBAS systems.
Status.NTPSource1Connected	BOOL	Used to indicate if the NTP Time Source 1 is connected.
Status.NTPSource2Connected	BOOL	Used to indicate if the NTP Time Source 2 is connected.
Status.isPtpGrandMaster	BOOL	The local TSM is the Grandmaster on the 1588 PTP network.
Status.GpsSpoofingDetected	BOOL	Will indicate if GPS Spoofing is detected.
InterferenceIndication	REAL	This is the indicator (0-100%) of the currently detected narrowband interference over all currently configured signal bands.  NOTE: It is necessary to run the receiver in an unjammed environment to determine an appropriate value for the unjammed

		case. If the value rises significantly above this threshold, this indicates that a continuous wave jammer is present.
SatelliteCount	SINT	This is the count of satellites used for the position and time fix.
DateTime.UTC	LINT	<p>This is the amount of microseconds since January, 1, 1970. When displayed in the Date/Time format the current date will be shown with the relevant time zone offset. The time zone offset that will be applied is that of the PC.</p> <p> NOTE: The UTC time in the input image is accurate time. Thus in systems where CIPSync/PTP cannot be used and the user is setting the wallclock time with a SSV instruction the UTC time in the input image of the TimeSync module must be used as the source. The UTC time is as accurate as the configured module RPI (min of 1ms).</p> <p> NOTE: When using the TSM EDS AOP to add the module to the Logix IO tree, the UTC will be structured as two DINTs rather than a single LINT. The user will need to copy the two DINTs to a single LINT if the full UTC with date time view wants to be used.</p>
DateTime.Year	INT	Current year.
DateTime.Month	SINT	Current month.
DateTime.Day	SINT	Current day.
DateTime.Hour	SINT	Current hour.
DateTime.Minute	SINT	Current minute.
DateTime.Second	SINT	Current second.
DateTime.Nanosecond	DINT	Current nanosecond.
Velocity.TrueCourseOverGround	REAL	This is the true course over ground and is measured in degrees from true north.
Velocity.SpeedOverGroundKnots	REAL	The current speed of the module's antenna in Knots.
Velocity.SpeedOverGroundKmh	REAL	The current speed of the module's in Km/h.
Position.Latitude	REAL	Current latitude in degrees format (e.g. -26.106388 degrees). A negative indicates the position is in the southern hemisphere.

Position.Longitude	REAL	Current longitude in degrees format (e.g. 28.00225 degrees). A negative indicates the position is in the western hemisphere.
Position.Altitude	REAL	Current altitude in meters above mean sea level.
Position.ReferenceLatitude	REAL	The reference latitude position from the output assembly in degrees format (e.g. -26.106388 degrees).
Position.ReferenceLongitude	REAL	The reference longitude position from the output assembly in degrees format (e.g. 28.00225 degrees).
Position.ReferenceAltitude	REAL	Reference altitude from the output assembly in meters.
Position.RelativeLatitude	REAL	Relative latitude in degrees format (Raw latitude less Reference latitude). A negative would indicate south of the reference LLA position.
Position.RelativeLongitude	REAL	Relative longitude in degrees format (Raw longitude less Reference longitude). A negative would indicate west of the reference LLA position.
Position.RelativeAltitude	REAL	Relative altitude in meters format (Raw altitude less Reference altitude).
Position.RelativeNorth	REAL	Relative distance in meters from the reference position along the North-South axis. A positive number indicates the antenna is currently north of the reference position.
Position.RelativeEast	REAL	Relative distance in meters from the reference position along the East-West axis. A positive number indicates the antenna is currently east of the reference position.
Odometer.DistanceSinceReset	DINT	Distance travelled (in meters) since the last reset.
Odometer.DistanceTotal	DINT	Distance travelled (in meters) since the module was powered for the first time.
Odometer.DistanceAccuracy	DINT	Estimated accuracy (in meters) of the distance travelled since last reset.
Accuracy.PDOP	REAL	Position dilution of precision. See section 2.4 for a better understanding as well as the GPS information in section 1.4.
Accuracy.HDOP	REAL	Horizontal dilution of precision. See section 2.4 for a better understanding as well as the GPS information in section 1.4.
Accuracy.VDOP	REAL	Vertical dilution of precision. See section 2.4 for a better understanding as well as the GPS information in section 1.4.
Accuracy.LatitudeError	REAL	Estimated error (in meters) of the latitude provided.
Accuracy.LongitudeError	REAL	Estimated error (in meters) of the longitude provided.
Accuracy.AltitudeError	REAL	Estimated error (in meters) of the altitude provided.

Table 5.2. - RSLogix / Studio 5000 input assembly parameters.

5.4.2. OUTPUT ASSEMBLY

The following parameters are used in the output assembly of the module.

Parameter	Datatype	Description
ReferenceLatitude	REAL	The reference latitude position in degrees format (e.g. -26.106388 degrees).
ReferenceLongitude	REAL	The reference longitude position in degrees format (e.g. 28.00225 degrees).
ReferenceAltitude	REAL	Reference altitude in meters.

Table 5.3. – RSLogix / Studio 5000 output assembly parameters.

5.5. MODBUS SERVER MAPPING

The Time Sync module will operate as a Modbus TCP Server unless the user has selected Modbus TCP for the Remote Target (in which case the module will be a Modbus Master). A Modbus Master can read the time, position, and velocity data from the Time Sync module and write the reference position using Holding Registers (HR).

The user will need to configure the Node Address and Holding Register Start address for the time, position, and velocity data. For example, if the user has configured a Holding Register Start address of 40010 (as shown below), then time, position, and velocity data will be from HR 40010 to HR 40079. If the user reads outside of these configurable ranges, then a Modbus Error will be returned. In the above example, the reference position that can be written to will be at HR 40110.



NOTE: The user will need to ensure that when using Modbus to write the reference position data, the TSM is not owned by Logix as well (this will cause contention of data).

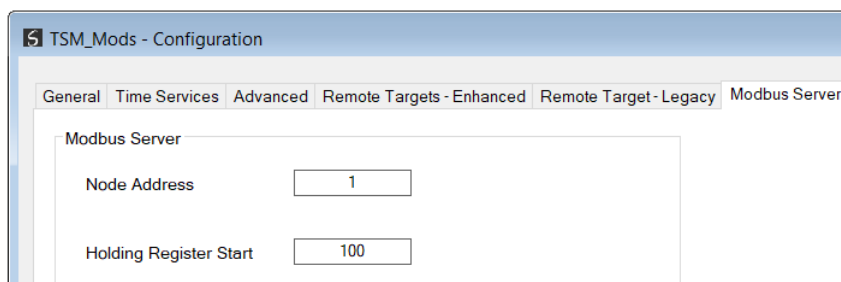

Figure 5.8 - Modbus Server parameters.

Below is the structure of the data that is **Read-Only** when acting as a Modbus Server.

Register Type:	Holding Registers			
Parameter	Byte Length	Date Type	Modbus Offset from Start Address	Description
UTC	8	UINT64	0	This is the number of microseconds since January 1, 1970. When displayed in the Date/Time format the current date will be shown with the relevant time zone offset. The time zone offset that will be applied is that of the PC.
Year	2	UINT16	4	Current GPS year.
Month	2	UINT16	5	Current GPS month.
Day	2	UINT16	6	Current GPS day.
Hour	2	UINT16	7	Current GPS hour.
Minute	2	UINT16	8	Current GPS minute.
Second	2	UINT16	9	Current GPS second.
Nanosecond	4	UINT32	10	Current nanosecond.
Reserved	4	FLOAT	12	-
UTC Week	4	UINT32	14	Current UTC Week Number.
UTC Time of week	4	UINT32	16	Current seconds for this UTC Week.
Leap Second	4	UINT32	18	Current leap second.
GPS Quality	2	UINT16	20	0-no fix; 1-Autonomous GNSS Fix; 2-Differential GNSS fix; 6-Estimated/dead reckoning fix
GPS Fix Type	2	UINT16	21	1-No Fix 2-2D Fix 3-3D fix
GPS SV Count	2	UINT16	22	Number of Satellite vehicles fixed.
Reserved	2	UINT16	23	-
Velocity - True course over ground	4	FLOAT	24	This is the true course over ground and is measured in degrees from true north.
Velocity - Speed over ground (knots)	4	FLOAT	26	The current speed of the module's antenna in Knots.
Velocity - Speed over ground (km/h)	4	FLOAT	28	The current speed of the module's in Km/h.
Position - Latitude	4	FLOAT	30	Current latitude in degrees format (e.g. -26.106388 degrees). A negative indicates the position is in the southern hemisphere.
Position - Longitude	4	FLOAT	32	Current longitude in degrees format (e.g. 28.00225 degrees). A negative indicates the position is in the western hemisphere.

Position - Altitude	4	FLOAT	34	Current altitude in meters above mean sea level.
Position - Reference Latitude	4	FLOAT	36	The reference latitude position from the output assembly in degrees format (e.g. -26.106388 degrees).
Position - Reference Longitude	4	FLOAT	38	The reference longitude position from the output assembly in degrees format (e.g. 28.00225 degrees).
Position - Reference Altitude	4	FLOAT	40	Reference altitude from the output assembly in meters.
Position - Relative Latitude	4	FLOAT	42	Relative latitude in degrees format (Raw latitude less Reference latitude). A negative would indicate south of the reference LLA position.
Position - Relative Longitude	4	FLOAT	44	Relative longitude in degrees format (Raw longitude less Reference longitude). A negative would indicate west of the reference LLA position.
Position - Relative Altitude	4	FLOAT	46	Relative altitude in meters format (Raw altitude less Reference altitude).
Position - Relative North	4	FLOAT	48	Relative distance in meters from the reference position along the North-South axis. A positive number indicates the antenna is currently north of the reference position.
Position - Relative East	4	FLOAT	50	Relative distance in meters from the reference position along the East-West axis. A positive number indicates the antenna is currently east of the reference position.
Odometer - Distance Since Reset	4	UINT32	52	Distance travelled (in meters) since the last reset.
Odometer - Distance Total	4	UINT32	54	Distance travelled (in meters) since the module was powered for the first time.
Odometer - Distance Accuracy	4	UINT32	56	Estimated accuracy (in meters) of the distance travelled since last reset.
Accuracy - PDOP	4	FLOAT	58	Position dilution of precision. See section 2.4 for a better understanding as well as the GPS information in section 1.4.
Accuracy - HDOP	4	FLOAT	60	Horizontal dilution of precision. See section 2.4 for a better understanding as well as the GPS information in section 1.4.
Accuracy - VDOP	4	FLOAT	62	Vertical dilution of precision. See section 2.4 for a better understanding as well as the GPS information in section 1.4.
Accuracy - Latitude Error	4	FLOAT	64	Estimated error (in meters) of the latitude provided.
Accuracy - Longitude Error	4	FLOAT	66	Estimated error (in meters) of the longitude provided.

Accuracy - Altitude Error	4	FLOAT	68	Estimated error (in meters) of the altitude provided.
---------------------------	---	-------	----	---

Table 5.4. – Modbus Mapping for Holding Register Read-Only.

Below is the structure of the data that is **Write-Only** when acting as a Modbus Server.

Register Type:	Holding Registers			
Parameter	Byte Length	Date Type	Modbus Offset from Start Address	Description
ReferenceLatitude	4	FLOAT	100	The reference latitude position in degrees format (e.g. -26.106388 degrees).
ReferenceLongitude	4	FLOAT	102	The reference longitude position in degrees format (e.g. 28.00225 degrees).
ReferenceAltitude	4	FLOAT	104	Reference altitude in meters.
Time Zone	2	INT	106	The Time zone is a signed value in minutes. For example a value of 120 would indicate a time zone of UTC + 2 (120minutes = 2hours). A value of -180 would indicate a time zone of UTC – 3 (180minutes = 3hours).

Table 5.5. – Modbus Mapping for Holding Register Write-Only.

6. DIAGNOSTICS

6.1. LEDS

The module provides three LEDs for diagnostics purposes as shown in the front view figure below. A description of each LED is given in the table below.



Figure 6.1 - Time Sync module front view.

LED	Description
Module	<p>The module LED will provide information regarding the system-level operation of the module. Thus, if the LED is red then the module is not operating correctly. For example, if the module application firmware has been corrupted or there is a hardware fault the module will have a red Module LED.</p> <p>If the LED is green then the module has booted and is running correctly.</p>
PPS	<p>The PPS LED is the pulse per second provided by the GPS receiver. When the LED is green the module has obtained an Autonomous or Differential fix based on a sufficient number of satellites. When red, it indicates the module is still trying to obtain a GNSS fix.</p>
Ethernet	<p>The Ethernet LED will light up when an Ethernet link has been detected (by plugging in a connected Ethernet cable). The LED will flash every time traffic was detected.</p>

Table 6.1. - Module LED operation.

6.2. MODULE STATUS MONITORING IN SLATE

The Time Sync can provide a range of statistics which can assist with module operation, maintenance, and fault finding. The statistics can be accessed in full by Slate or using the web server in the module.

To view the module's status in the Aparian-Slate environment, the module must be online. If the module is not already Online (following a recent configuration download), then right-click on the module and select the *Go Online* option.

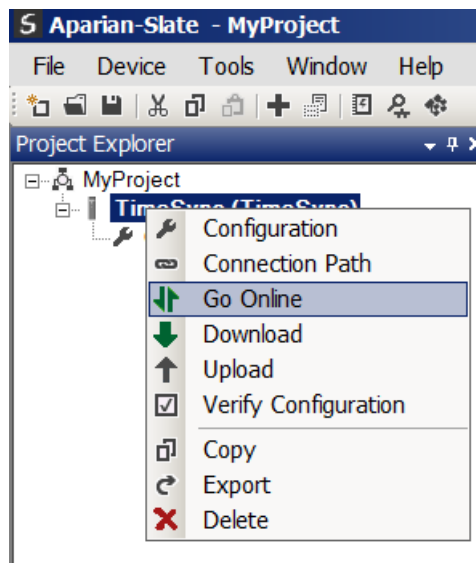

Figure 6.2. - Selecting to Go Online.

The Online mode is indicated by the green circle behind the module in the Project Explorer tree.

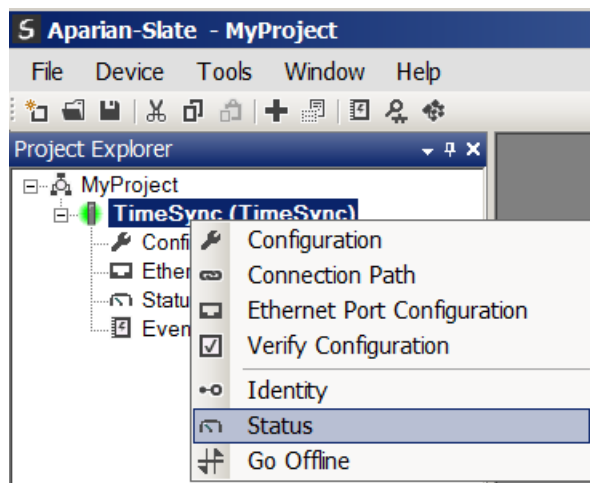

Figure 6.3. - Selecting online Status.

The Status monitoring window can be opened by either double-clicking on the *Status* item in the Project Explorer tree, or by right-clicking on the module and selecting *Status*.

The status window contains multiple tabs to display the current status of the module. Most of these parameters in the status windows are self-explanatory or have been discussed in previous sections.

6.2.1. GENERAL

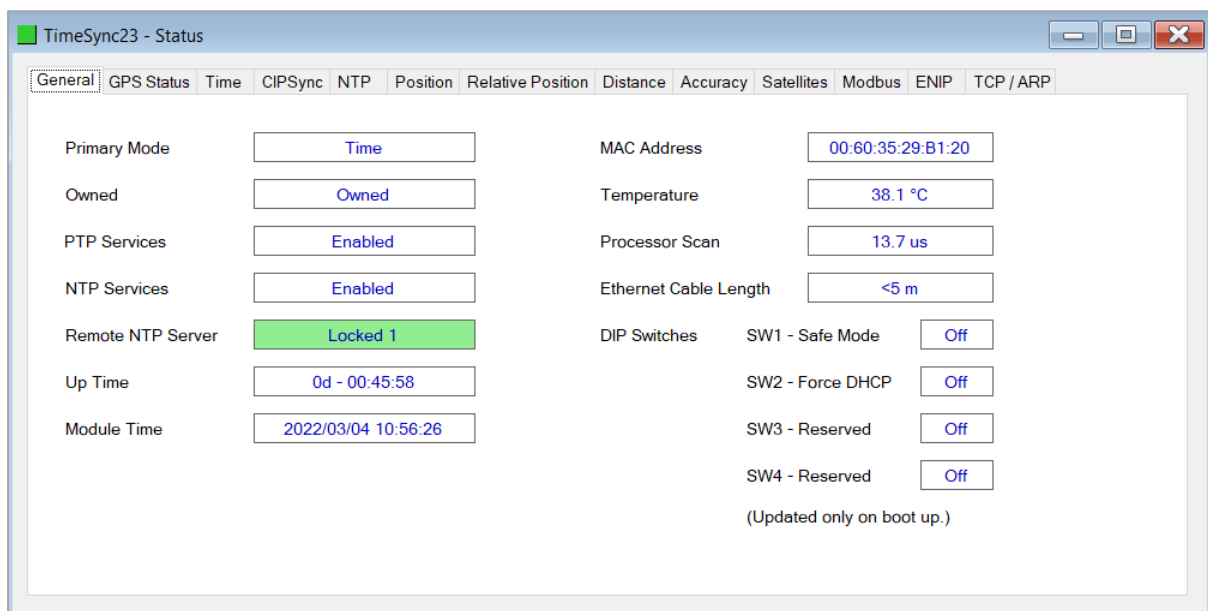

Figure 6.4. - Status monitoring – General.

The General tab displays the following general parameters and can also be used to set the module time to the PC time:

Parameter	Description
Primary Mode	Indicates the current operating mode: Time Position Custom
Owned	Indicates whether or not the module is currently owned (Class 1) by a Logix controller.
PTP Services	Indicates if PTP has been enabled.
NTP Services	Indicates if NTP has been enabled.

Remote NTP Server	When the Time Source is NTP, this field will indicate if the TSM is connected to an external NTP Time Server and if it is NTP Server 1 or NTP Server 2.
Up Time	Indicates the elapsed time since the module was powered-up.
Module Time	Indicates the module's internal time. The module time is stored in UTC (Universal Coordinate Time) but displayed on this page according to the local PC Time Zone settings.
MAC Address	Displays the module's unique Ethernet MAC address.
Temperature	The internal temperature of the module.
Processor Scan	The amount of time (microseconds) taken by the module's processor in the last scan.
Ethernet Cable Length	This is an estimate of the Ethernet Cable Length accurate to 5m.
DIP Switch Position	The status of the DIP switches when the module booted. Note that this status will not change if the DIP switches are altered when the module is running.

Table 6.2. - Parameters displayed in the Status Monitoring – General Tab.

6.2.2. GPS STATUS

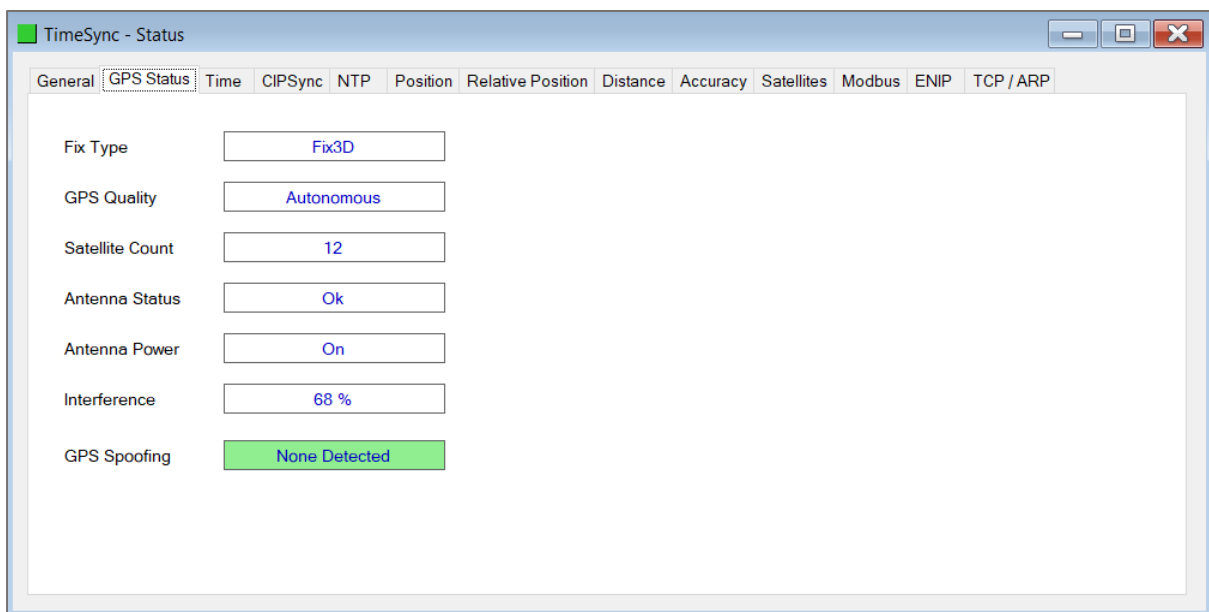

Figure 6.5. - Status monitoring – GPS Status.

The GPS Status tab displays the following information regarding the GPS receiver and GPS antenna:

Parameter	Description
Fix Type	<p>No Fix The GPS receiver has not obtained a fix on a sufficient number of satellites.</p> <p>Fix2D The GPS receiver has obtained a 2-dimensional fix.</p> <p>Fix3D the GPS receiver has obtained a 3-dimensional fix</p>
GPS Quality	<p>No Fix The GPS receiver has not obtained a fix on a sufficient number of satellites.</p> <p>Autonomous The GPS receiver has obtained autonomous fix. This bit can be used to determine if the module has sufficient satellites to provide accurate time and position information.</p> <p>Differential The GPS receiver has obtained differential fix. This will only be possible if the differential satellite constellation has been enabled (i.e. SBAS). When the module is set into position mode the SBAS constellation is automatically enabled. In time mode it is disabled. WAAS (North America) and EGNOS (Europe) are examples of SBAS systems.</p>
Satellite Count	This is the count of satellites used for the position and time fix.
Antenna Status	<p>Ok The Antenna is operating correctly.</p> <p>Antenna Short The Antenna is drawing more current than expected which may indicate a coax cable short-circuit.</p> <p>Antenna Open The Antenna is drawing less current than expected which may indicate coax cable is open circuit.</p>
Antenna Power	<p>On The Antenna is powered correctly.</p> <p>Off The Antenna is not powered correctly.</p>
Interference	<p>This is the indicator (0-100%) of the currently detected narrowband interference over all currently configured signal bands.</p> <p>NOTE: It is necessary to run the receiver in an unjammed environment to determine an appropriate value for the unjammed case. If the value rises significantly above this threshold, this indicates that a continuous wave jammer is present.</p>
GPS Spoofing	Will indicate if GPS Spoofing is detected.

Table 6.3. - Status Monitoring – GPS Status Tab

6.2.3. TIME

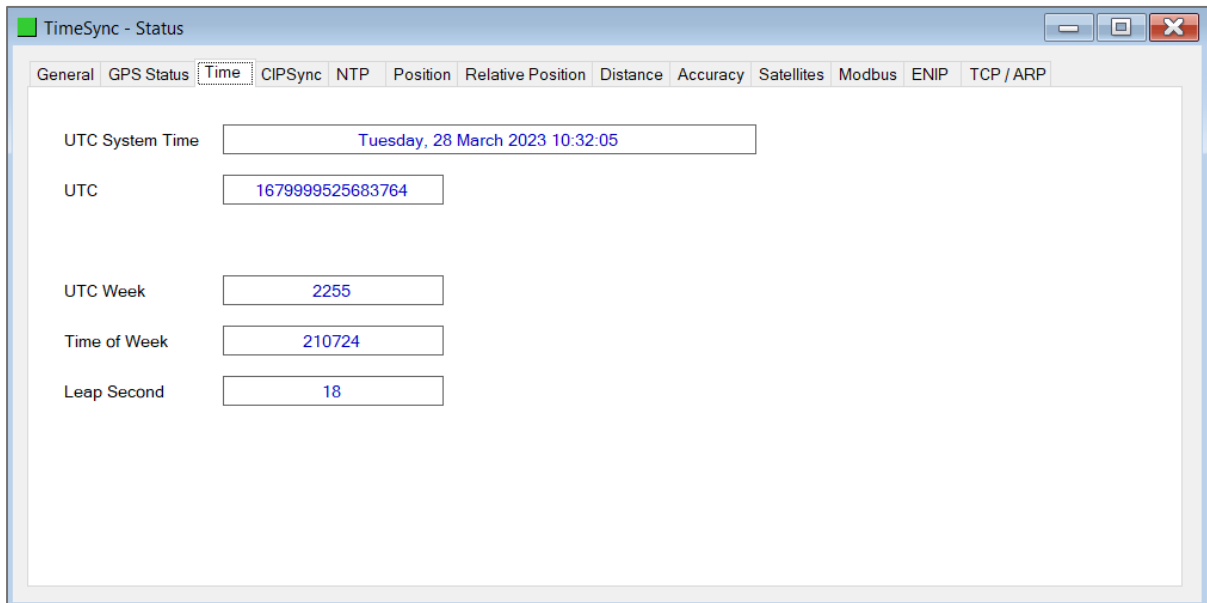

Figure 6.6. - Status monitoring – Time.

The Time tab displays the following information regarding the internal Time of the Time Sync Module:

Parameter	Description
UTC System Time	The local UTC time in the module, in Gregorian format.
UTC	The local UTC time in the module, in seconds format.
UTC Week	The local UTC week number.
Time of Week	The local number of seconds passed in this week.
Leap Second	The current leap second.

Table 6.4. - Status Monitoring – Time Tab

6.2.4. CIP SYNC

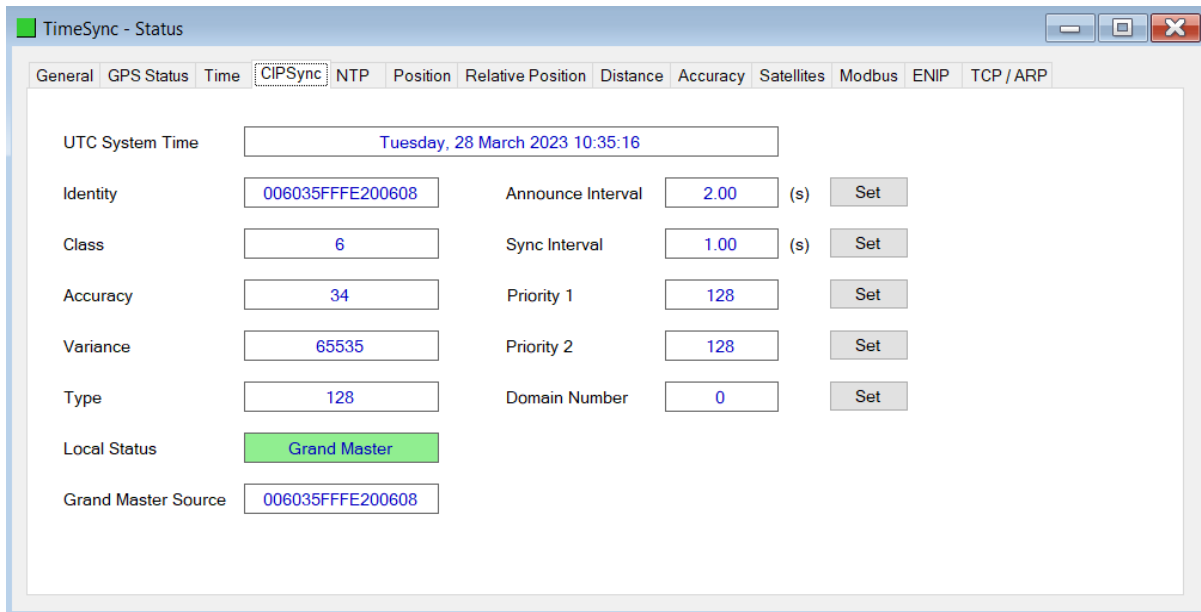

Figure 6.7. - Status monitoring – CIP Sync

The CIP Sync tab displays the following information regarding the CIP Sync Parameters which can be adjusted:

Parameter	Description
UTC System Time	The local UTC time in the module, in Gregorian format.
Identity	1588 PTP clock Identity which will be used to identify the local module on the 1588 PTP network.
Class	6 – Synchronized to a primary reference source (e.g., GPS). 7 – Was synchronized to a primary reference source, but has lost the ability to obtain time from that source. 13 - Synchronized to a application specific time source (e.g., NTP). 14 – Was synchronized to an application specific source, but has lost the ability to obtain time from that source. 248 – Default clock class if none of the other apply.
Accuracy	34 – Time is accurate to 250ns 35 – Time is accurate to 1000ns 41 – Time is accurate to 1000us 43 – Time is accurate to 10ms 254 – Time accuracy is unknown
Variance	65535 – Variance not calculated
Type	128 – PTP Ordinary Clock
Local Status	Grand Master – local TSM is the PTP Grand Master on the Ethernet network.

	Not Grand Master – local TSM is not the PTP Grand Master on the Ethernet network.
Grand Master Source	The clock identity of the PTP Grand Master.
1588 PTP Parameters	
Announce Interval	Interval at which the PTP Announce packets are sent when the local TSM is the PTP Grand Master. NOTE: It is recommended that the user do not change these parameters.
Sync Interval	Interval at which the PTP Sync and Follow-up packets are sent when the local TSM is the PTP Grand Master. NOTE: It is recommended that the user do not change these parameters.
Priority 1	Master Override – This priority setting can be used to override any clock on the PTP network and become the PTP Grand Master. The lower the value the higher the priority of the local clock.
Priority 2	Tie Breaker – When two clocks have the same clock quality and accuracy, this priority setting can be used to prioritise the local such that it becomes the PTP Grand Master. The lower the value the higher the priority of the local clock.
Domain Number	This is used when multiple PTP networks exist on the same Ethernet network.

Table 6.5. - Status Monitoring – CIP Sync Tab.

6.2.5. NTP

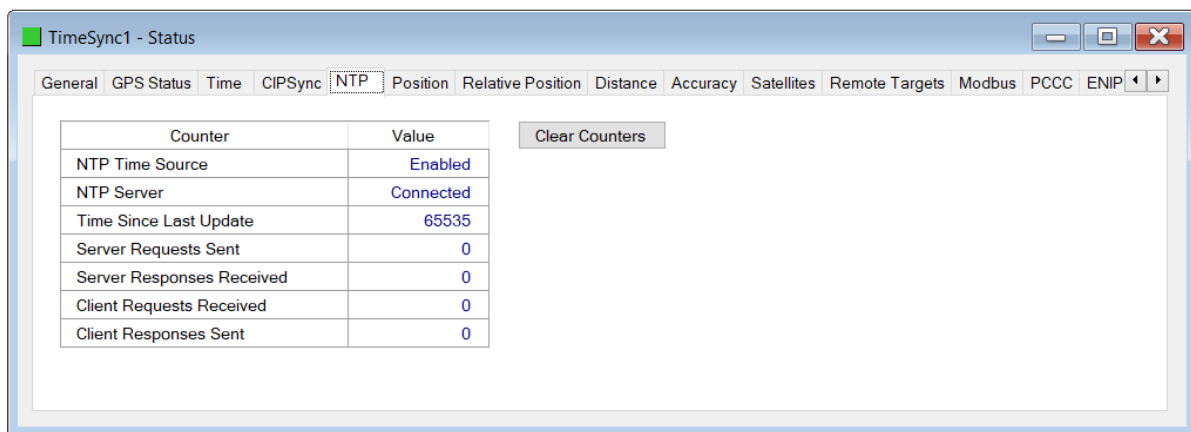

Figure 6.8. - Status monitoring – NTP.

The NTP tab displays the following NTP parameters and statistics:

Parameter	Description
NTP Time Source	Indicates if the Time Source of the TSM is NTP.
NTP Server	Indicates if the NTP Server is connected.
Time Since Last Update	The time (in seconds) since the last update from the NTP Server

Server Requests Sent	The number of NTP time requests sent
Server Responses Received	The number of NTP time responses received
Client Requests Received	The number of NTP time requests received from remote clients
Client Responses Sent	The number of NTP time responses sent to remote clients

Table 6.6. - Parameters displayed in the Status Monitoring – NTP.

6.2.6. POSITION

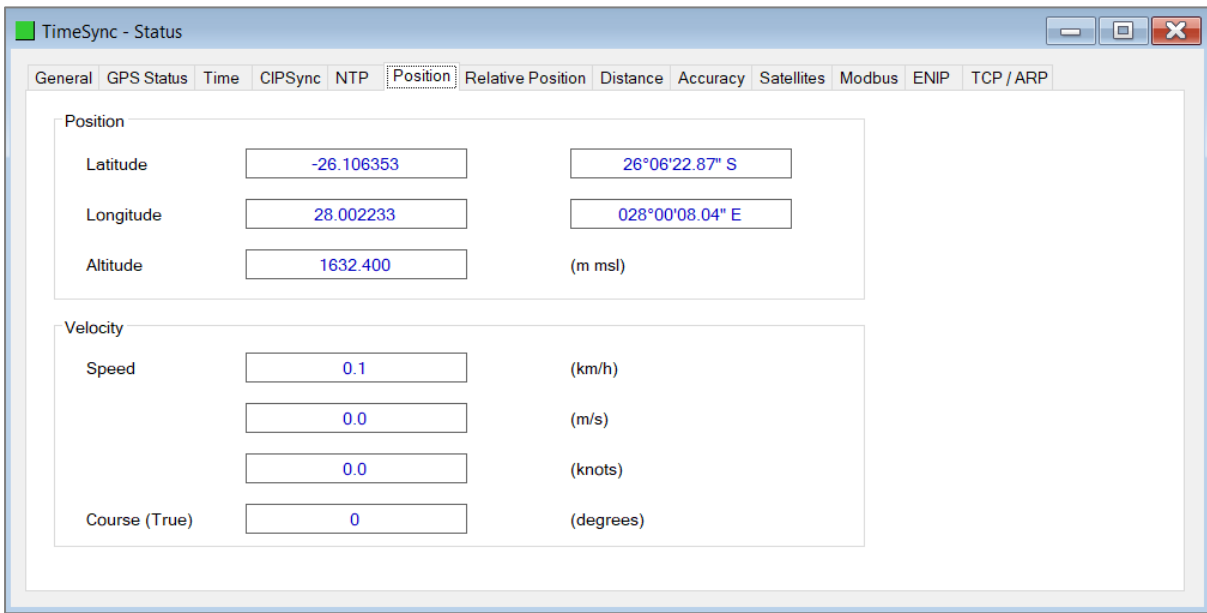

Figure 6.9. - Status monitoring – Position.

The Position tab displays the following information regarding the GPS Position and Velocity of the GPS antenna connected:

Parameter	Description
Position	
Latitude	The current Latitude position of the GPS antenna when it has a satellite fix. The position is given in decimal degrees and degrees, minutes, and seconds.
Longitude	The current Longitude position of the GPS antenna when it has a satellite fix. The position is given in decimal degrees and degrees, minutes, and seconds.
Altitude	The current Altitude position of the GPS antenna when it has a satellite fix. The position is given in meters from mean sea level (msl).
Velocity	

Speed	The current speed of the GPS antenna in kilometres per hour, meters per second, and knots.
Course (True)	The true course heading in degrees.

Table 6.7. - Status Monitoring – Position.

6.2.7. RELATIVE POSITION

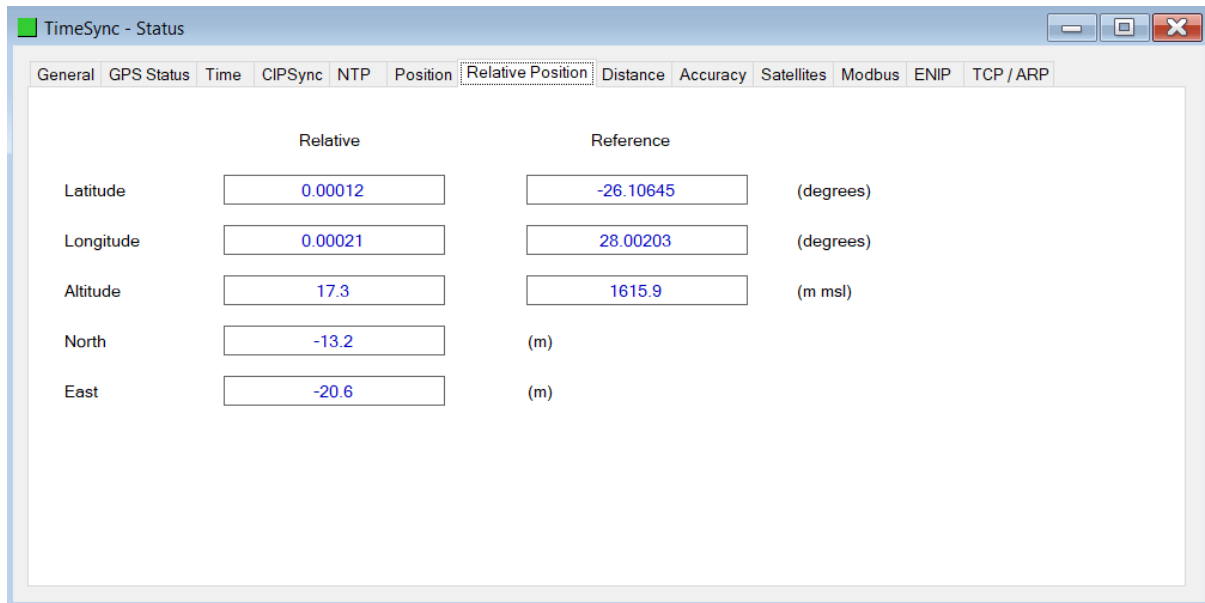

Figure 6.10. - Status monitoring – Relative Position.

The Relative Position tab displays the following information regarding the Relative Position of the TSM based on the reference position provide to the module:

Parameter	Description
Latitude	The current relative Latitude position of the GPS antenna when it has a satellite fix. The relative position is calculated from the reference position provided to the TSM. The reference Latitude position is also provided. The position is given in decimal degrees.
Longitude	The current relative Longitude position of the GPS antenna when it has a satellite fix. The relative position is calculated from the reference position provided to the TSM. The reference Longitude position is also provided. The position is given in decimal degrees.
Altitude	The current relative Altitude position of the GPS antenna when it has a satellite fix. The relative position is calculated from the reference position provided to the TSM.

	The reference Altitude position is also provided. The position is given in meters from mean sea level (msl).
North	The relative North position calculated from the current GPS position and reference position. The position is given in meters (m).
East	The relative East position calculated from the current GPS position and reference position. The position is given in meters (m).

Table 6.8. - Status Monitoring – Relative Position.

6.2.8. DISTANCE

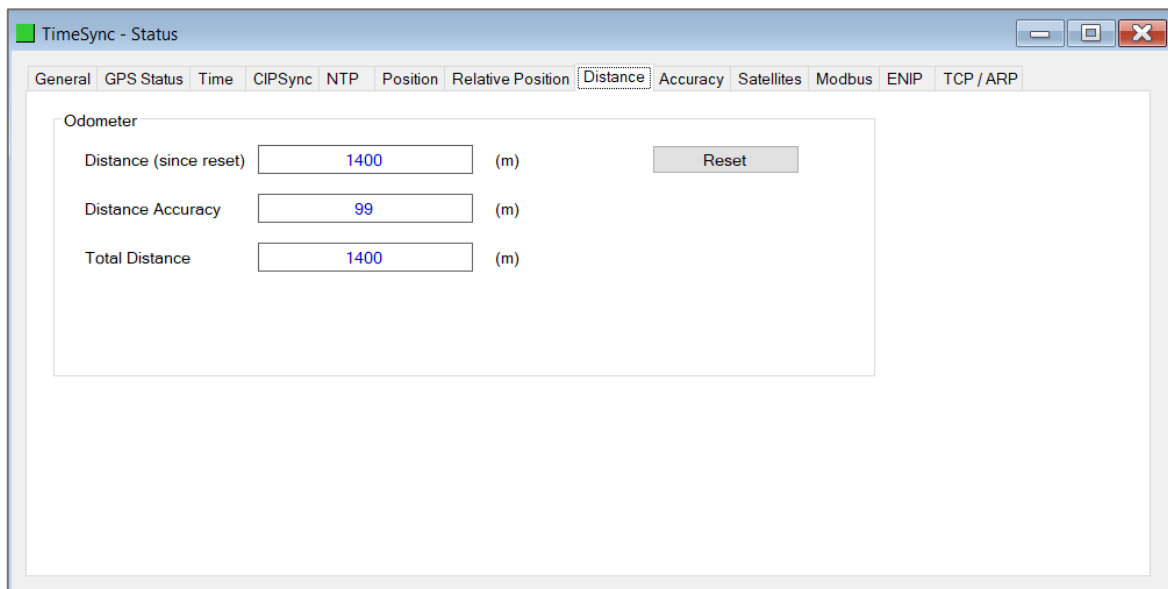

Figure 6.11. - Status monitoring – Distance

The Distance tab displays the distance travelled by the GPS receiver:

Parameter	Description
Distance (since reset)	The distance (in meters) that the GPS antenna has moved since the module booted.
Distance Accuracy	The accuracy (in meters) of the distance provided.
Total Distance	The total distance (in meters) the GPS has moved since the last time a reset command was issued.

Table 6.9. - Status Monitoring – Distance.

6.2.9. ACCURACY

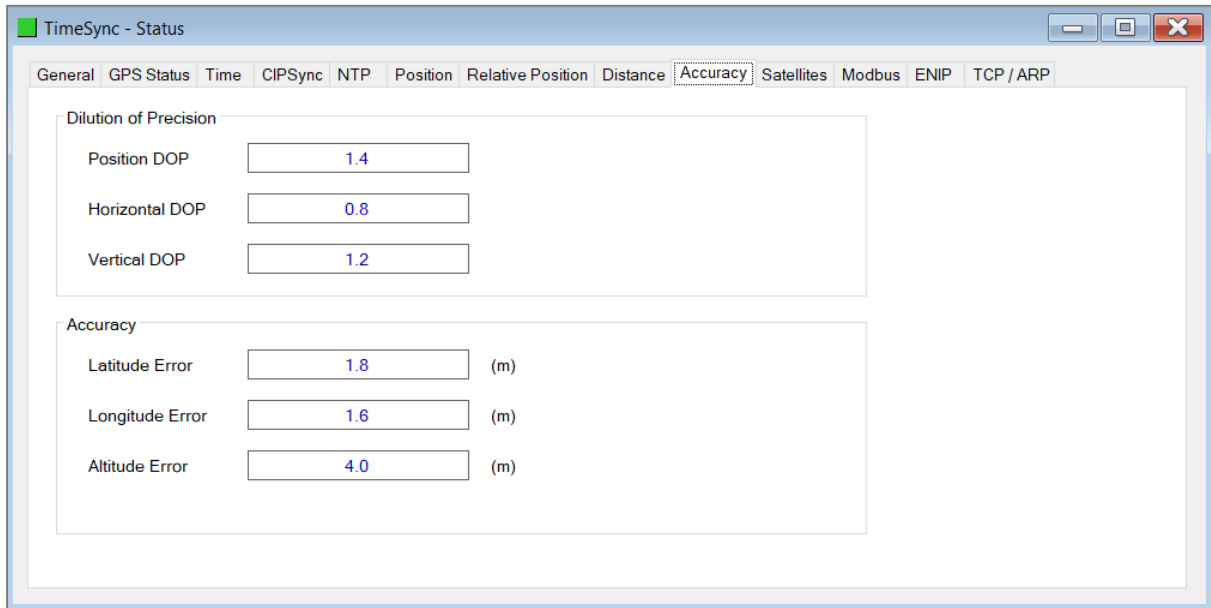

Figure 6.12. - Status monitoring – Distance.

The Accuracy tab provide the Dilution of Precision and Accuracy information for the GPS receiver:

Parameter	Description
Dilution of Precision	
Position DOP	Position Dilution of Precision.
Horizontal DOP	Horizontal Dilution of Precision.
Vertical DOP	Vertical Dilution of Precision.
Accuracy	
Latitude Error	The standard deviation of latitude error (in meters).
Longitude Error	The standard deviation of longitude error (in meters).
Altitude Error	The standard deviation of altitude error (in meters).

Table 6.10. - Status Monitoring – Accuracy.

6.2.10. SATELLITES

Constellation	Name	PRN	Status	SNR	Elevation	Azimuth
GPS	G1	1	Stale	0	0	119
GPS	G2	2	Active	44	25	220
GPS	G3	3	Stale	8	-1	140
GPS	G4	4	Stale	9	-1	145
GPS	G5	5	Active	42	55	205
GPS	G6	6	Active	29	21	69
GPS	G7	7	Inactive	18	4	128
GPS	G8	8	Stale	0	0	84
GPS	G9	9	Stale	0	0	143
GPS	G10	10	Stale	0	0	10
GPS	G11	11	Active	39	55	102
GPS	G12	12	Active	21	7	315
GPS	G13	13	Active	48	67	10
GPS	G14	14	Stale	0	0	15
GPS	G15	15	Active	29	45	322

Figure 6.13. - Status monitoring – Satellites.

The Satellite page will display all the satellites from various constellations used for position fix. If a certain constellation is disabled (e.g. GLONASS, when module is operating in Time mode) then these satellites will be displayed as either Inactive or Stale.

6.2.11. REMOTE TARGETS

The Remote Targets tab displays the status of each of the configured Remote Targets, when the module is operating in Enhanced Remote Target mode.

Remote Type	Action	IP Address	File:Reg	Last Ok (s)	Next (s)	TimeZone	Status
MicroLogix 1400	Set Time	192.168.1.30	RTC:0	402	0	120	Success
MicroLogix 1400	Get Time Zone	192.168.1.30	N10:20	349	0	120	Success
Micro800	Set Time	192.168.1.126	CIP Object	56232	0	120	Message Failed : PrivilegeViolation
Modbus TCP	Set Time	192.168.1.118:10	HR: 5100	152009	0	120	Failed to Connect
PLC5	Set Time	192.168.1.240	S2:18	392	0	120	Success
SLC500/MicroLogix	Set Time	192.168.1.241	S2:37	402	0	120	Success

Figure 6.14. – Status monitoring – Remote Targets.

The Remote Targets tab displays the following parameters:

Statistic	Description
Remote Type	The remote target device type, as specified in the configuration.
Action	The remote action, as specified in the configuration.
IP Address	The IP address of the remote target, as specified in the configuration.
File : Reg	The remote target File and Register number as specified in the configuration.
Last Ok (s)	The number of seconds that have elapsed since the last successful action.
Next (s)	The number of seconds until the action is triggered again.
Time Zone	The Time Zone (in minutes from UTC) that was used when the previous action was triggered.
Status	<p>The status of the previous action, either:</p> <p>Success The previous action was successful.</p> <p>Uninitialized The action has not been executed since the module powering-up, or new configuration downloaded.</p> <p>Failed to Connect The module was unable to establish connection to the remote target.</p> <p>Message Failed The message failed. Depending on the type of message, additional status may be shown.</p> <p style="text-align: center;">NOTE: A “Privilege Violation” error may occur with a Micro800 if the “Allow real time clock to be changed in run mode” option has not been selected in the Micro800’s configuration.</p> <p>Invalid Value The Time Zone value read is not valid. (-720 to 720 minutes).</p>

Table 6.11. – Remote Target Status

6.2.12. MODBUS

The Modbus tab displays the Modbus statistics for when the TSM is operating as a Modbus TCP Client or Modbus TCP Server.

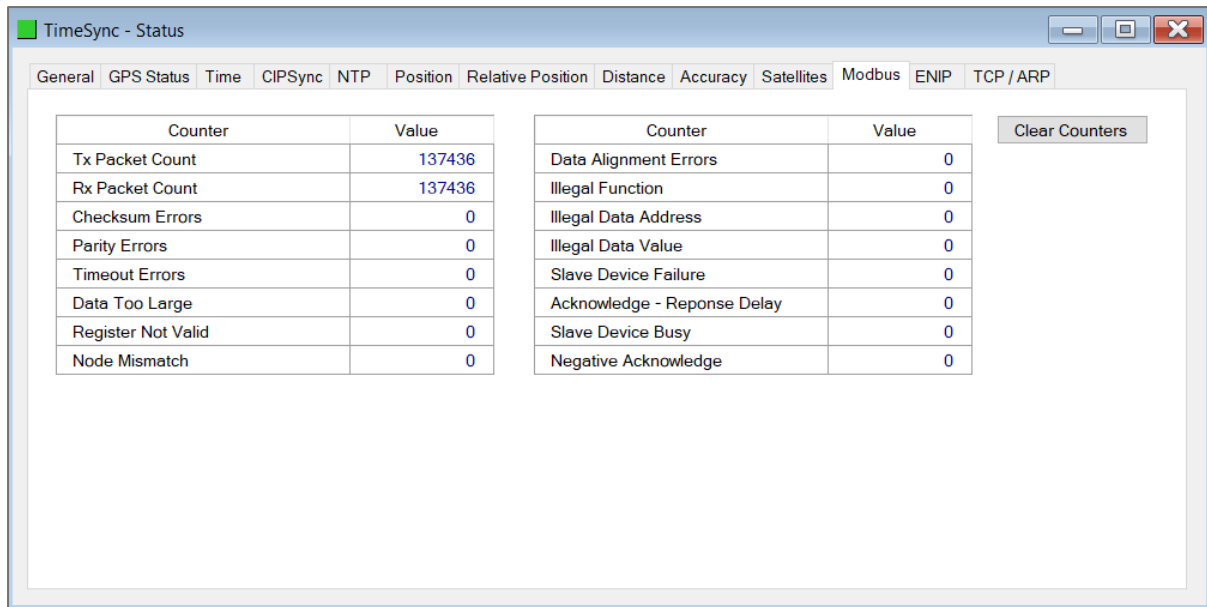

Figure 6.15. – Status monitoring – Modbus Statistics

The Modbus tab displays the following parameters:

Statistic	Description
Tx Packet Count	The number of Modbus packets sent by the module.
Rx Packet Count	The number of Modbus packets received by the module.
Checksum errors	The number of corrupted Modbus packets received by the module.
Parity errors	The number of bytes with parity errors received by the module.
Timeout Errors	The number of message response timeouts the module has encountered.
Data Too Large	The number of Modbus requests or responses where the data was too large to process.
Map Item Not Found	The number of Modbus requests did not match any mapped items.
Node Mismatch	The received Modbus request did not match the module's Modbus node address.
Data Alignment Errors	The Modbus request and associated mapped item is not byte aligned with the destination Logix tag.
Illegal Function	The number of times the Modbus device responded with an Illegal Function exception.
Illegal Data Address	The number of times the Modbus device responded with an Illegal Data Address exception.
Illegal Data Value	The number of times the Modbus device responded with an Illegal Data Value exception.
Server Device Failure	The number of times the Modbus device responded with a Device Failure exception.

Acknowledge –Response Delay	The number of times the Modbus device responded with an Acknowledge exception.
Server Device Busy	The number of times the Modbus device responded with a Server Busy exception.
Negative Acknowledge	The number of times the Modbus device responded with a Negative Acknowledge exception.
Memory Parity Error	The number of times the Modbus device responded with a Memory Parity exception.

Table 6.12. - Modbus Statistics

6.2.13. PCCC

The PCCC tab displays the PCCC statistics for the TSM.

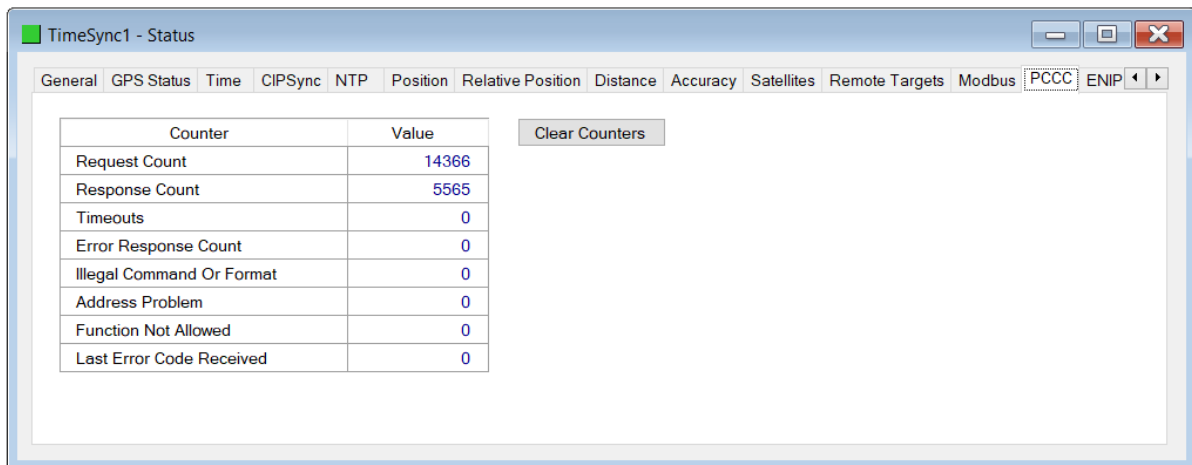

Figure 6.16. – Status monitoring – PCCC Statistics

The PCCC tab displays the following parameters:

Statistic	Description
Request Count	The number of PCCC request packets sent by the module.
Response Count	The number of PCCC response packets received by the module.
Timeout Errors	The number of PCCC message response timeouts the module has encountered.
Error Response Count	The number of PCCC error responses received by the module.
Illegal Command or Format	The number of PCCC responses indicating that an illegal command was sent.
Address Problem	The number of PCCC requests where the data address was not valid
Function Not Allowed	The number of times the PCCC device responded with a Function Not Allowed exception.

Last Error Code Received	The value of the last error code from the remote device.
--------------------------	--

Table 6.13. - PCCC Statistics.

6.2.14. ENIP

The Ethernet Clients tab displays details of the Ethernet and EtherNet/IP clients connected to the Time Sync Module.

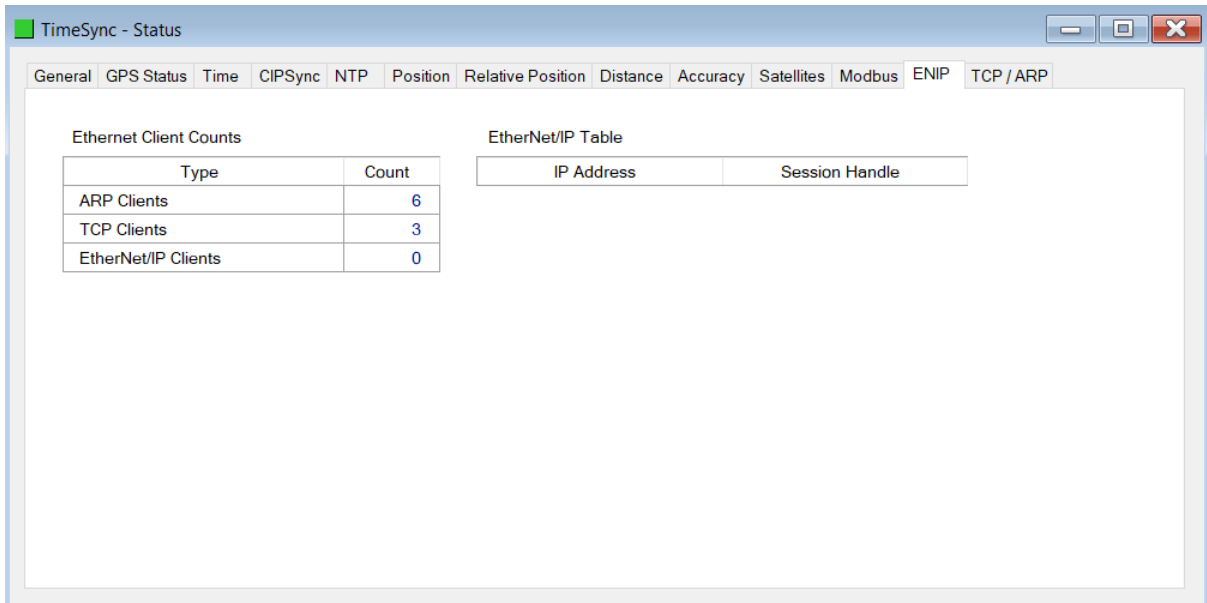

Figure 6.17 – Status monitoring – Ethernet Client Statistics.

6.2.15. TCP / ARP

The TCP/ARP tab displays details of the internal Ethernet ARP and TCP lists of the Time Sync Module.

The screenshot shows a window titled "TimeSync - Status" with several tabs: General, GPS Status, Time, CIPSync, NTP, Position, Relative Position, Distance, Accuracy, Satellites, Modbus, ENIP, and TCP / ARP. The "TCP / ARP" tab is active, displaying two tables: "ARP Table" and "TCP Table".

ARP Table	
MAC Address	IP Address
00:1D:9C:C3:D5:B1	192.168.1.8
00:60:35:38:B0:8B	192.168.1.114
2C:69:1D:C1:00:47	192.168.1.186
00:60:35:29:B1:20	192.168.1.236
B4:45:06:0E:F9:60	192.168.1.218
00:1D:9C:CD:2F:D8	192.168.1.7

TCP Table		
MAC Address	Remote Port	Local Port
00:60:35:38:B0:8B	502	48321
00:1D:9C:C3:D5:B1	63120	44818
B4:45:06:0E:F9:60	63364	44818

Figure 6.18 – Status monitoring – Ethernet TCP / ARP Statistics.

6.3. MODULE EVENT LOG

The Time Sync module logs various diagnostic records to an internal event log. These logs are stored in non-volatile memory and can be displayed using Slate or via the web interface. To view them in Slate, select the Event Viewer option in the Project Explorer tree.

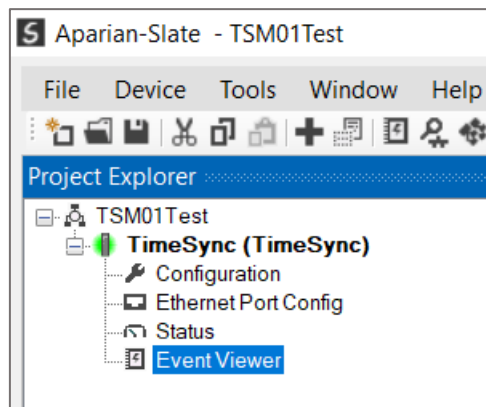
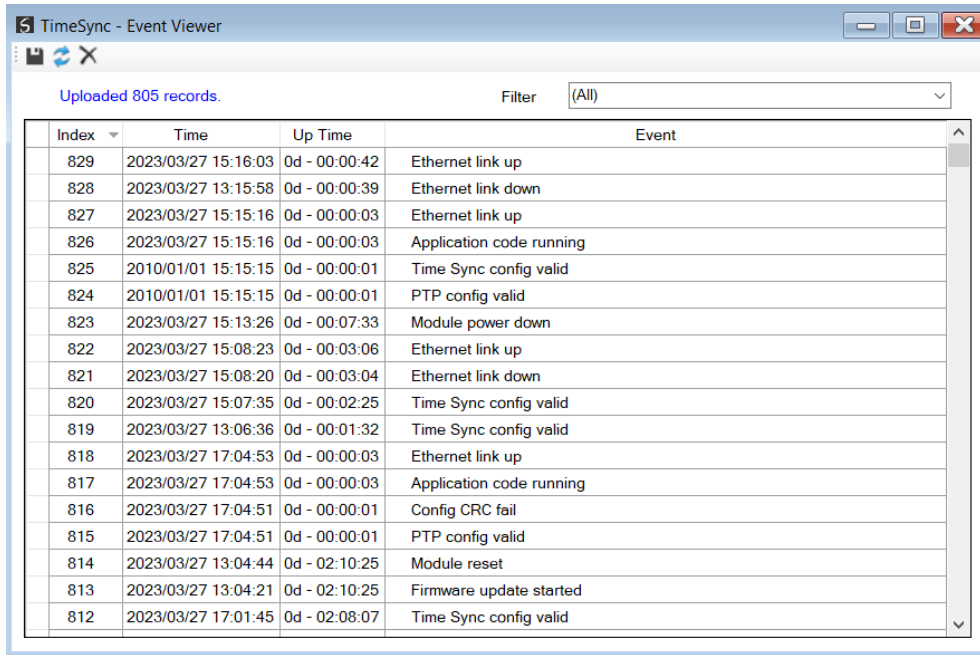

Figure 6.19. - Selecting the module Event Log.

The Event Log window will open and automatically read all the events from the module. The log entries are such that the latest record at the top. Custom sorting is achieved by double-clicking on the column headings.



Index	Time	Up Time	Event
829	2023/03/27 15:16:03	0d - 00:00:42	Ethernet link up
828	2023/03/27 13:15:58	0d - 00:00:39	Ethernet link down
827	2023/03/27 15:15:16	0d - 00:00:03	Ethernet link up
826	2023/03/27 15:15:16	0d - 00:00:03	Application code running
825	2010/01/01 15:15:15	0d - 00:00:01	Time Sync config valid
824	2010/01/01 15:15:15	0d - 00:00:01	PTP config valid
823	2023/03/27 15:13:26	0d - 00:07:33	Module power down
822	2023/03/27 15:08:23	0d - 00:03:06	Ethernet link up
821	2023/03/27 15:08:20	0d - 00:03:04	Ethernet link down
820	2023/03/27 15:07:35	0d - 00:02:25	Time Sync config valid
819	2023/03/27 13:06:36	0d - 00:01:32	Time Sync config valid
818	2023/03/27 17:04:53	0d - 00:00:03	Ethernet link up
817	2023/03/27 17:04:53	0d - 00:00:03	Application code running
816	2023/03/27 17:04:51	0d - 00:00:01	Config CRC fail
815	2023/03/27 17:04:51	0d - 00:00:01	PTP config valid
814	2023/03/27 13:04:44	0d - 02:10:25	Module reset
813	2023/03/27 13:04:21	0d - 02:10:25	Firmware update started
812	2023/03/27 17:01:45	0d - 02:08:07	Time Sync config valid

Figure 6.20. – Module Event Log.

The log can also be stored to a file for future analysis, by selecting the Save button in the tool menu.

To view previously saved files, use the **Event Log Viewer** option under the **Tools** menu.

6.4. WEB SERVER

The Time Sync module provides a web server allowing a user without Slate or RSLogix 5000 to view various diagnostics of the module. This includes Ethernet parameters, system event log, advanced diagnostics, and application diagnostics (GPS diagnostics).



NOTE: The web server is view **only** and thus no parameters or configuration can be altered from the web interface.

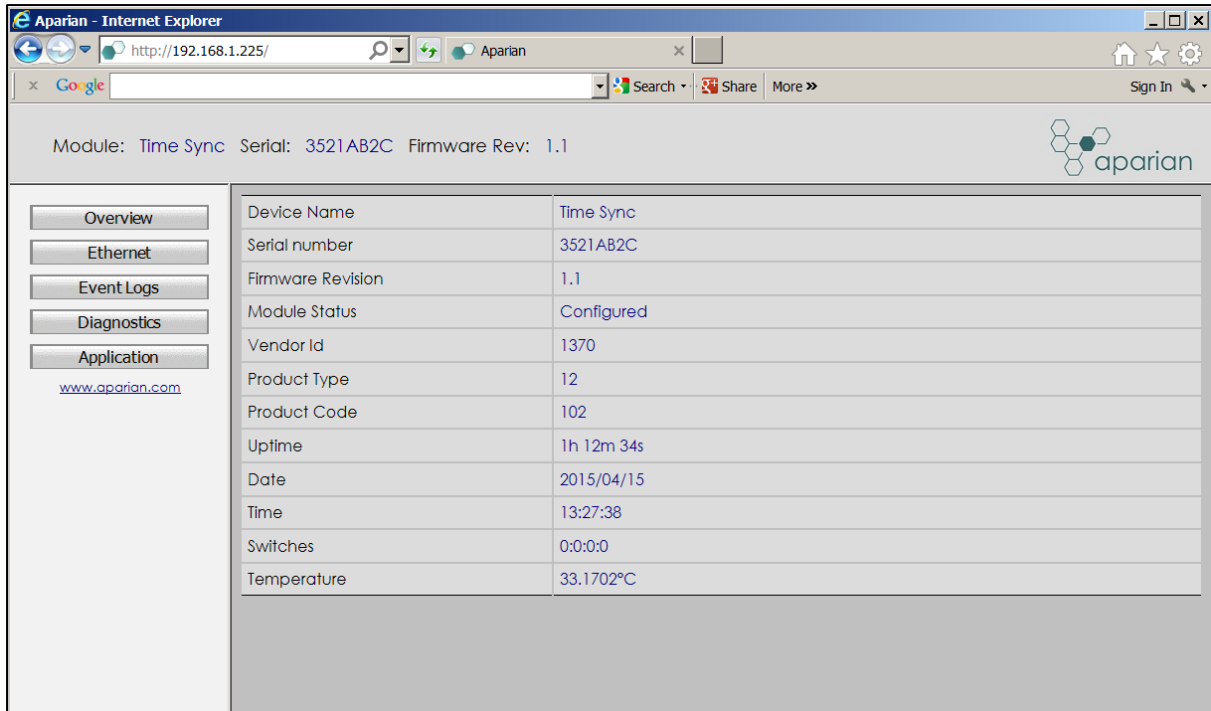

Figure 6.21. - Web interface.

7. TECHNICAL SPECIFICATIONS

7.1. DIMENSIONS

Below are the enclosure dimensions as well as the required DIN rail dimensions. All dimensions are in millimetres.

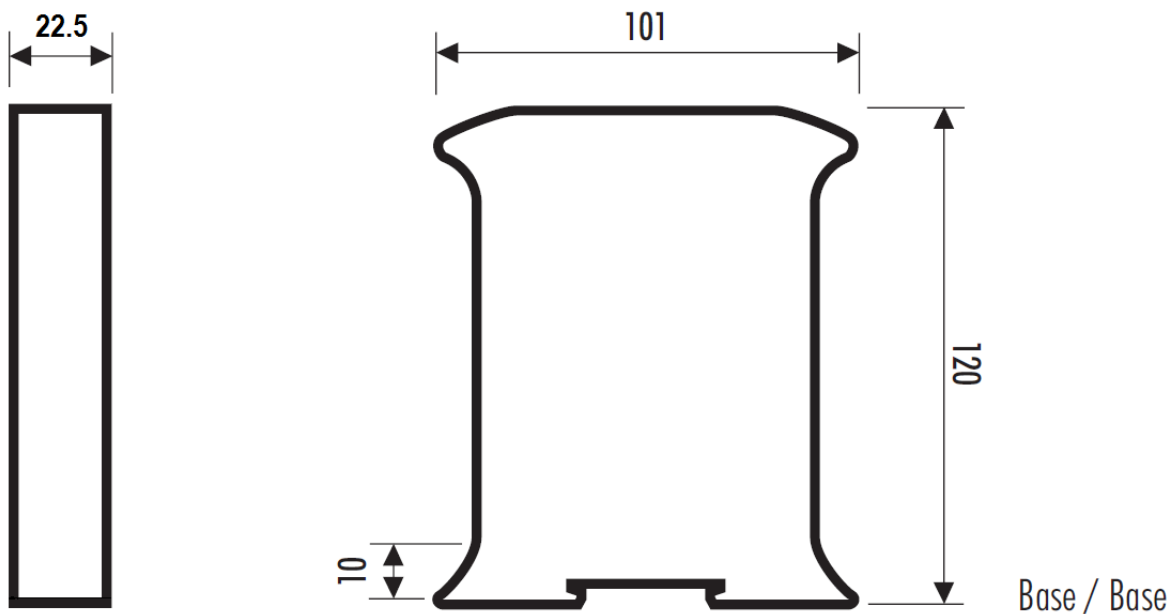

Figure 7.1 – Time Sync enclosure dimensions.

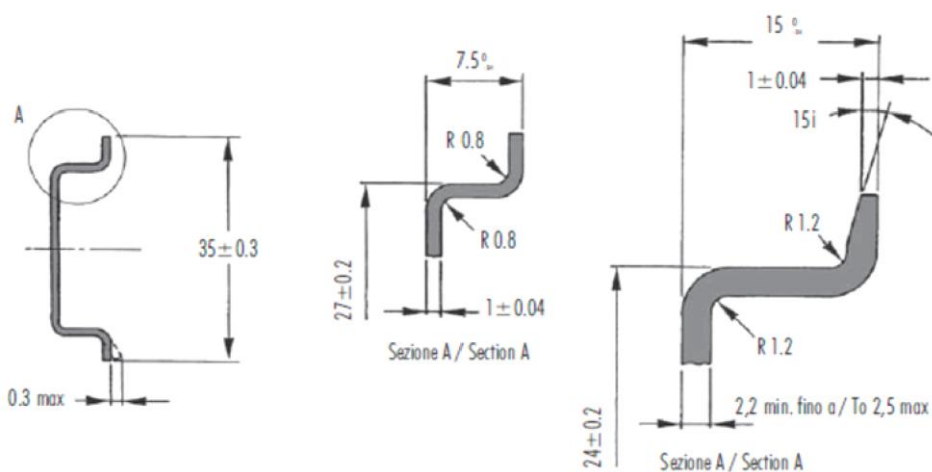

Figure 7.2 - Required DIN dimensions.

7.2. ELECTRICAL

Specification	Rating
Power requirements	Input: 10 – 32V DC, (80 mA @ 24 VDC)
Power consumption	1.9 W
Connector	3-way terminal
Conductors	24 – 18 AWG
Enclosure rating	IP20, NEMA/UL Open Type
Temperature	-20 – 70 °C
Earth connection	Yes, terminal based
Emissions	IEC61000-6-4
ESD Immunity	EN 61000-4-2
Radiated RF Immunity	IEC 61000-4-3
EFT/B Immunity	EFT: IEC 61000-4-4
Surge Immunity	Surge: IEC 61000-4-5
Conducted RF Immunity	IEC 61000-4-6

Table 7.1. - Electrical specification.

7.3. ETHERNET

Specification	Rating
Connector	RJ45
Conductors	CAT5 STP/UTP
ARP connections	Max 100
TCP connections	Max 20
CIP connections	Max 10
Communication rate	10/100Mbps
Duplex mode	Full/Half
Auto-MDIX support	Yes

Table 7.2. - Ethernet specification.

7.4. GPS

Specification	Rating
Antenna Port	SMA-Female
Supported Constellations	GPS / QZSS, GLONASS, SBAS, BeiDou
Velocity accuracy	0.05 m/s
Heading accuracy	0.3 degrees
Horizontal position accuracy	2.5m (Autonomous) 2.0m (SBAS)
Accuracy of time pulse signal	60ns
Altitude limit	50,000m
Velocity limit	500 m/s
Odometer support	Yes
Relative Position support	Yes
Isolated	Yes*

* Series B only.

Table 7.3. - GPS specification.

7.5. GPS ANTENNA

Specification	Rating
Antenna Connector	SMA-Male
Cable Length	3m
Cable Type	RG174
Antenna Type	Active
Active Gain	27dB (typical)
Noise figure	1.5 (maximum)
Voltage	2.7 – 5.5 VDC
Temperature	-35°C to +85 °C
Enclosure description	Rugged low profile, UV resistant.

Table 7.4. - GPS Antenna specification.

7.6. 1588 PTP / NTP

Specification	Rating
NTP support (PC time synchronization)	Yes
NTP Time Source supported	Yes
NTP Client Count Max	90
1588 PTP Grandmaster support	Yes
1588 PTP Management Support	Yes
1588 PTP End-to-End (E2E) Delay Mechanism Support	Yes
1588 PTP Peer-to-Peer (P2P) Delay Mechanism Support	Yes
1588 PTP / NTP GPS clock source support	Yes
1588 PTP Holdover reporting support	Yes
1588 PTP Network Transport	IPv4 UDP IEEE802.3
1588 PTP Client Count Max	100

Table 7.5. – 1588 PTP / NTP specification.

7.7. LEGACY DEVICE TIME SYNCHRONIZATION

Specification	Rating
Allen-Bradley PLC5 time synchronization	Yes
Allen-Bradley SLC time synchronization	Yes
Modbus Device register updating	Yes
Legacy Device Auto Time Zone support	Yes

Table 7.6. – Legacy Device Time Synchronization specification.

7.8. CERTIFICATIONS







Certification	Mark
CE Mark	
UL Mark File: E494895	 LISTED CLASS 1, DIV 2, GROUPS A, B, C, D Note: The TSM/B UL Hazardous Certification extends to include the antenna and antenna cable, provided that: <ul style="list-style-type: none"> • The antenna must be of type: <ul style="list-style-type: none"> ○ BULLET III (Trimble) , or ○ ANT-GPSUKS (RF Solutions) • The antenna cable may not exceed 300 ft in total, and must be of type: <ul style="list-style-type: none"> ○ LMR240-FR, or ○ LMR400-FR, or ○ LMR600-FR.
ODVA Conformance	 * F/W 1.008
RoHS2 Compliant	
RCM	
KCC	 R-R-Apn-TSMB
UKCA	

Table 7.7. – Certifications.

INDEX

A

antenna, 8, 12, 15, 16, 57, 58, 59, 62
Antenna, 15
assembly instance, 38

C

CIPSync, 11, 52
Constellation, 30
Contact Us, 11

D

DC power, 12
DHCP, 14, 19
dimensions, 85
DIN rail, 14, 15, 85
DIP, 13, 14

E

Ethernet Bridge, 38
Ethernet connector, 18

F

firmware upgrade, 26

G

GPS, 6, 8, 9, 11, 12, 13, 15, 16, 27, 29, 30, 52, 58, 60, 63,
65, 69, 83, 87

H

HDOP, 16, 60

I

input assembly, 58, 68, 73
input voltage, 15

L

LED, 65

M

MODBUS, 79

N

Network Time Protocol. *See* NTP
NTP, 6, 8, 9, 11, 28, 46, 47, 53, 58, 67

O

odometer, 8, 10, 29, 30, 41, 57
output assembly, 55, 57, 61

P

PDOP, 16, 60
position, 6, 8, 9, 10, 16, 21, 27, 56, 57, 58, 59, 60, 61, 62,
63, 64, 69, 77, 87
Positioning, 56
PPS, 13, 65
Precision Time Protocol. *See* PTP
Primary mode, 27
PTP, 6, 8, 9, 11, 28, 52, 53, 58, 67

R

requested packet interval (RPI), 39
Rockwell Automation, 23
RSLinx, 23
RSLogix 5000, 37, 38, 39, 40, 42, 55, 57, 60, 61, 83

S

Safe Mode, 14
Slate, 25, 26, 58, 66, 83
Speed profile, 29
statistics, 66
Support email, 11

T

Time Sync, 6, 8, 25, 38, 57
TIME SYNC general configuration, 26
TIME SYNC parameters, 26
Time Synchronization, 52

U

User Defined Types (UDTs), 39

V

VDOP, 16, 60
velocity, 6, 8, 9, 10, 57

W

web server, 66, 83