



Where Automation Connects.



PLX82-MBTCP-PNC

Communication Gateway

Modbus TCP/IP to PROFINET Controller

May 8, 2025

USER MANUAL

Your Feedback Please

We always want you to feel that you made the right decision to use our products. If you have suggestions, comments, compliments or complaints about our products, documentation, or support, please write or call us.

ProSoft Technology, Inc.

+1 (661) 716-5100

+1 (661) 716-5101 (Fax)

www.prosoft-technology.com

ps.support@belden.com

PLX82-MBTCP-PNC User Manual

For Public Use.

May 8, 2025

ProSoft Technology®, is a registered copyright of ProSoft Technology, Inc. All other brand or product names are or may be trademarks of, and are used to identify products and services of, their respective owners.

Content Disclaimer

This documentation is not intended as a substitute for and is not to be used for determining suitability or reliability of these products for specific user applications. It is the duty of any such user or integrator to perform the appropriate and complete risk analysis, evaluation and testing of the products with respect to the relevant specific application or use thereof. Neither ProSoft Technology nor any of its affiliates or subsidiaries shall be responsible or liable for misuse of the information contained herein. Information in this document including illustrations, specifications and dimensions may contain technical inaccuracies or typographical errors. ProSoft Technology makes no warranty or representation as to its accuracy and assumes no liability for and reserves the right to correct such inaccuracies or errors at any time without notice. If you have any suggestions for improvements or amendments or have found errors in this publication, please notify us.

No part of this document may be reproduced in any form or by any means, electronic or mechanical, including photocopying, without express written permission of ProSoft Technology. All pertinent state, regional, and local safety regulations must be observed when installing and using this product. For reasons of safety and to help ensure compliance with documented system data, only the manufacturer should perform repairs to components. When devices are used for applications with technical safety requirements, the relevant instructions must be followed. Failure to use ProSoft Technology software or approved software with our hardware products may result in injury, harm, or improper operating results. Failure to observe this information can result in injury or equipment damage.

Copyright © 2025 ProSoft Technology, Inc. All Rights Reserved.



For professional users in the European Union

If you wish to discard electrical and electronic equipment (EEE), please contact your dealer or supplier for further information.



Warning – Cancer and Reproductive Harm – www.P65Warnings.ca.gov

Important Safety Information

Power, Input, and Output (I/O) wiring must be in accordance with Class I, Division 2 wiring methods, Article 501-4 (b) of the National Electrical Code, NFPA 70 for installation in the U.S., or as specified in Section 18-1J2 of the Canadian Electrical Code for installations in Canada, and in accordance with the authority having jurisdiction. The following warnings must be heeded:

WARNING - EXPLOSION HAZARD - SUBSTITUTION OF COMPONENTS MAY IMPAIR SUITABILITY FOR CLASS I, DIV. 2;

WARNING - EXPLOSION HAZARD - WHEN IN HAZARDOUS LOCATIONS, TURN OFF POWER BEFORE REPLACING OR WIRING MODULES

WARNING - EXPLOSION HAZARD - DO NOT DISCONNECT EQUIPMENT UNLESS POWER HAS BEEN SWITCHED OFF OR THE AREA IS KNOWN TO BE NON-HAZARDOUS.

Class 2 Power

Agency Approvals and Certifications

Please visit our website: www.prosoft-technology.com

Contents

Your Feedback Please	2
Content Disclaimer	2
Important Safety Information	3
1 Start Here	6
1.1 PLX82-MBTCP-PNC Overview	6
1.2 System Requirements	7
1.3 Shipping Contents	7
1.4 Setting Jumpers	8
1.5 Mounting the PLX82-MBTCP-PNC on a DIN-rail	8
1.6 Connecting Power	9
2 ProSoft Configuration Builder Software	10
2.1 Creating a New PCB Project	10
2.2 Setting a Project Name (Optional)	12
2.3 Setting a Temporary IP Address	13
2.4 Saving the Project	15
2.5 Downloading the Configuration File to the PLX82-MBTCP-PNC	16
2.6 Uploading the Configuration from the PLX82-MBTCP-PNC	18
2.7 Exporting a Project	19
2.8 Writing the Project to Compact Flash	20
3 Configuring Modbus TCP/IP	21
3.1 Configuring MBTCP Servers	21
3.2 Configuring MBTCP Client [x]	24
3.2.1 Configuring MBTCP Client [x] Commands	27
3.3 Configuring the MBTCP Remote Servers	32
3.4 MBTCP Port IP Address Configuration	33
4 Configuring the PROFINET Controller	35
4.1 PNC Controller Network Settings	35
4.2 Importing GSD Files	37
4.3 Adding Slave Devices to the Project	39
4.4 Configuring a Slave Device	40
4.5 Verifying Slave Device Information	42
4.5.1 Controller Network Settings	43
4.5.2 Device Table	44
4.5.3 IP Address Table	46
4.5.4 Process Data	47
4.5.5 Address Table	47
4.5.6 FSU-/Port-Settings	49
4.5.7 Stations Timing	51
4.5.8 Controller Settings	52
4.5.9 Ethernet Devices	54
4.5.10 Viewing Configured Device Information	59

5	PROFINET Start Input and Output Byte Offsets	62
<hr/>		
6	Acyclic Data	64
6.1	Read/Write Data	64
6.2	Alarm Data	68
<hr/>		
7	CommonNet Data Map	69
<hr/>		
8	Webpage	72
<hr/>		
9	Diagnostics and Troubleshooting	74
9.1	LEDs	74
9.2	PCB Diagnostics	76
9.2.1	PCB Menu Options	78
9.2.2	PROFINET General Status Codes	84
9.2.3	PROFINET Device Errors	85
9.2.4	Acyclic Read/Write Communication Status	85
9.2.5	Acyclic Read/Write PNIO Remote Procedure Call Status	86
9.3	Network Diagnostics	88
9.3.1	Establishing a Diagnostic Connection	93
9.3.2	General Diagnosis	96
9.3.3	Master Diagnosis	97
9.3.4	Station Diagnosis	98
9.3.5	Firmware Diagnosis	99
9.3.6	Extended Diagnosis	100
9.3.7	Tools	111
9.3.8	MBTCP Status Data in Upper Memory	118
9.3.9	MBTCP Error Codes	121
9.3.10	PNC Status Data in Upper Memory	122
<hr/>		
10	Reference	125
10.1	Specifications	125
10.1.1	Hardware Specifications	125
10.1.2	Modbus TCP/IP (MBTCP) Specifications	126
10.1.3	PROFINET (PNC) Specifications	126
10.2	Performance	127
<hr/>		
11	Support, Service & Warranty	128
11.1	Contacting Technical Support	128
11.2	Warranty Information	128

1 Start Here

1.1 PLX82-MBTCP-PNC Overview

The Modbus TCP/IP to PROFINET Controller gateway provides Modbus TCP/IP-based controllers with the ability to control up to 36 PROFINET RT devices such as field I/O, drives, HMIs, controllers, etc.

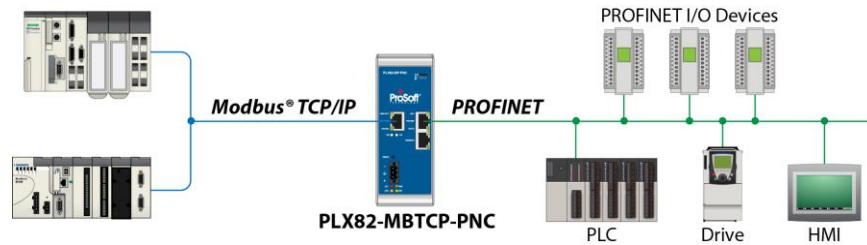

The PLX82-MBTCP-PNC gateways are stand-alone DIN-rail mounted units that provide two Ethernet ports for communications, remote configuration, and diagnostics. The onboard SD Card slot (SD card optional) is used for storing configuring files that can be used for recovery, transferring the configuration to another gateway, or general configuration backup.

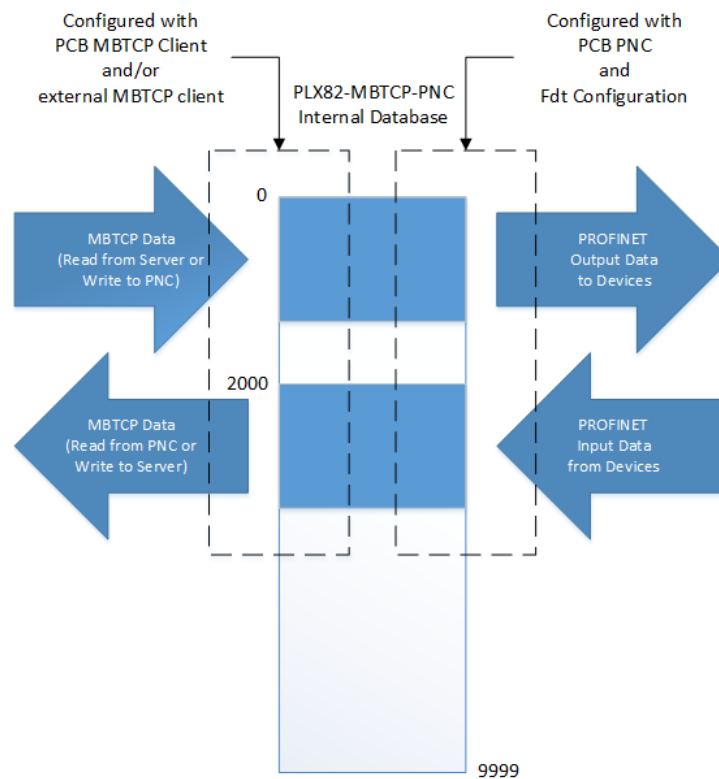

1.2 System Requirements

The ProSoft Configuration Builder configuration software for the PLX82-EIP-MBTCP gateway requires the following minimum hardware and software components:

- Pentium® II 450 MHz minimum. Pentium III 733 MHz (or better) recommended
- 128 Mbytes of RAM minimum, 256 Mbytes of RAM recommended
- 100 Mbytes of free hard disk space (or more based on application requirements)

Supported operating systems:

- Windows® 10 Professional (32-bit and 64-bit versions), 8 GB RAM Intel® Core™ i5/i7- 6xxx (3.20 GHz)
- Windows® 7 Professional (32-bit and 64-bit versions), 8 GB RAM Intel® Core™ i5 650 (3.20 GHz)
- Windows® XP Professional Ver.2002 Service Pack 2, 512 MB RAM Pentium 4 (2.66 Gz)

ProSoft FDT Configuration Manager software requirements:

- Microsoft .NET must be installed on the PC or laptop used to configure the gateway.
- 1 GHz minimum processor

Supported operating systems:

- Windows® XP SP3
- Windows® Vista (32-Bit) SP2
- Windows® 7 (32-Bit and 64-Bit) SP1
- Windows® 8 (32-Bit and 64-Bit)
- Windows® 8.1 (32-Bit and 64-Bit)
- Windows® 10 (32-Bit and 64-Bit)

1.3 Shipping Contents

The following components are included with the PLX82-MBTCP-PNC.

Qty.	Part Name	Part Number	Part Description
1	Modbus TCP/IP to PROFINET Controller	PLX82-MBTCP-PNC	ProSoft communication gateway
1	Screwdriver	HRD250	Small, flat-bladed screwdriver
1	Power Connector	J180	3-wire DC power connector

If any of these components are missing, please contact ProSoft Technology Technical Support for replacement parts.

1.4 Setting Jumpers

The jumper settings are located on the back of the PLX82-MBTCP-PNC. For security reasons, the *Mode 1* and *Mode 2* jumpers are not readily accessible. Under normal conditions, these two jumpers will not be required.

Setup Jumper

Mode 3 is jumpered by default. It is only required for firmware updates.

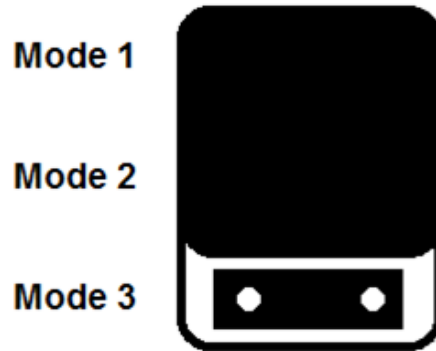

1.5 Mounting the PLX82-MBTCP-PNC on a DIN-rail

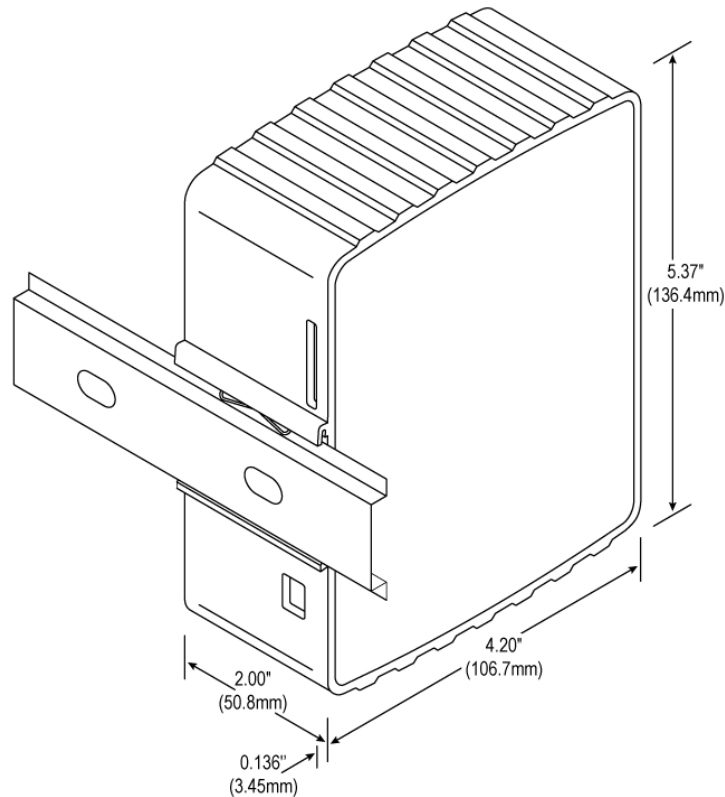

- 1 Position the PLX82-MBTCP-PNC on the DIN-rail B at a slight angle.
- 2 Hook the lip on the rear of the adapter onto the top of the DIN-rail, and rotate the adapter onto the rail.
- 3 Press the adapter down onto the DIN-rail until flush. The locking tab snaps into position and locks the module to the DIN-rail.
- 4 If the adapter does not lock in place, use a screwdriver or similar device to move the locking tab down while pressing the adapter flush onto the DIN-rail and release the locking tab to lock the adapter in place. If necessary, push up on the locking tab to lock.

1.6 Connecting Power



Use the J180 Power Connector to connect to the proper signals.

WARNING: Be sure not to reverse polarity when applying power to the PLX82-MBTCP-PNC. This causes permanent damage to the internal power distribution circuits.

2 ProSoft Configuration Builder Software

ProSoft Configuration Builder (PCB) and ProSoft fdt Configuration Manager are used to configure the PLX82-MBTCP-PNC. The software files can be downloaded at: www.prosoft-technology.com

Note: To use the ProSoft Configuration Builder under the Windows 7 OS, you must be sure to install it using the *Run as Administrator* option. To find this option, right-click the Setup.exe program icon, and then click **RUN AS ADMINISTRATOR** on the context menu. You must install using this option even if you are already logged in as an Administrator on your network or personal computer (PC). Using the Run as Administrator option allows the installation program to create folders and files on your PC with proper permissions and security. If you do not use the Run as Administrator option, the ProSoft Configuration Builder may appear to install correctly, but you will receive multiple file access errors whenever the ProSoft Configuration Builder is running, especially when changing configuration screens. If this happens, you must completely uninstall the ProSoft Configuration Builder and then re-install using the Run as Administrator option to eliminate the errors.

Note: The ProSoft fdt Configuration Manager software requires Microsoft.NET to be installed on the PC/laptop used to configure the module. The PC/laptop must have a 2 GHz minimum processor.

2.1 Creating a New PCB Project

- 1 From your PC, click **START > PROSOFT TECHNOLOGY > PROSOFT CONFIGURATION BUILDER**.
- 2 In the PCB window, click **FILE > NEW**. You are prompted to choose a *Module Type*.

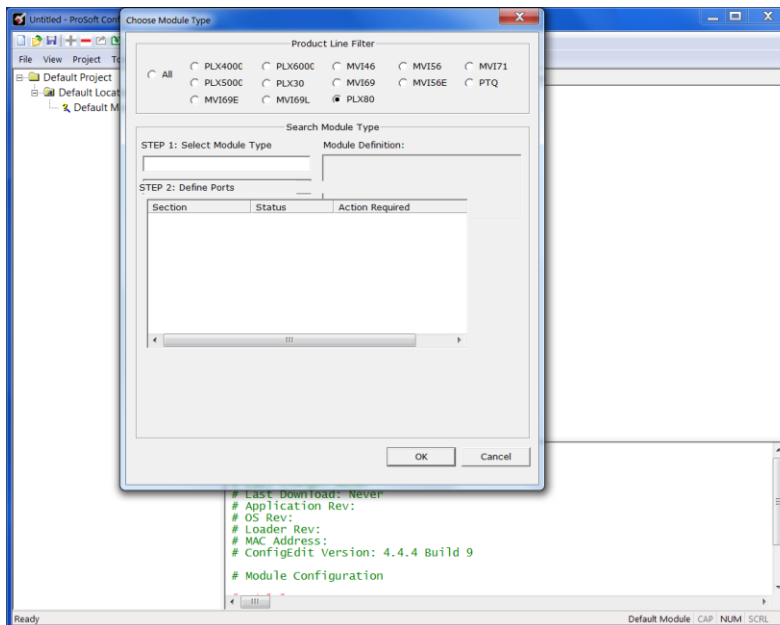

3 Select the **PLX80** radio button and then select **PLX82-MBTCP-PNC**.

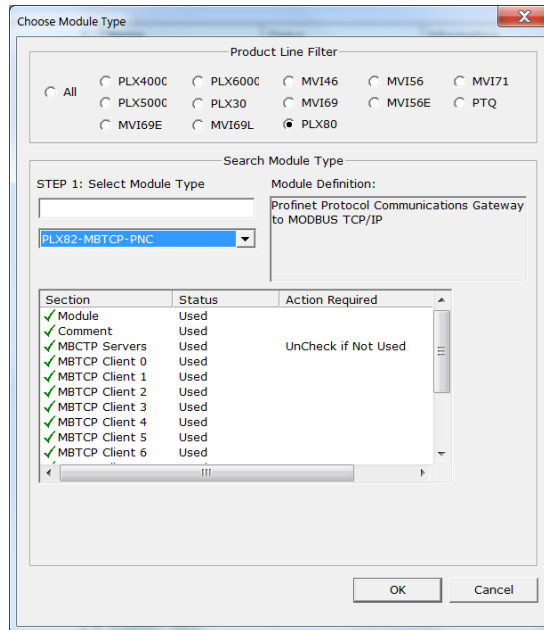

4 Click **OK**. The PLX82-MBTCP-PNC is now added to ProSoft Configuration Builder.

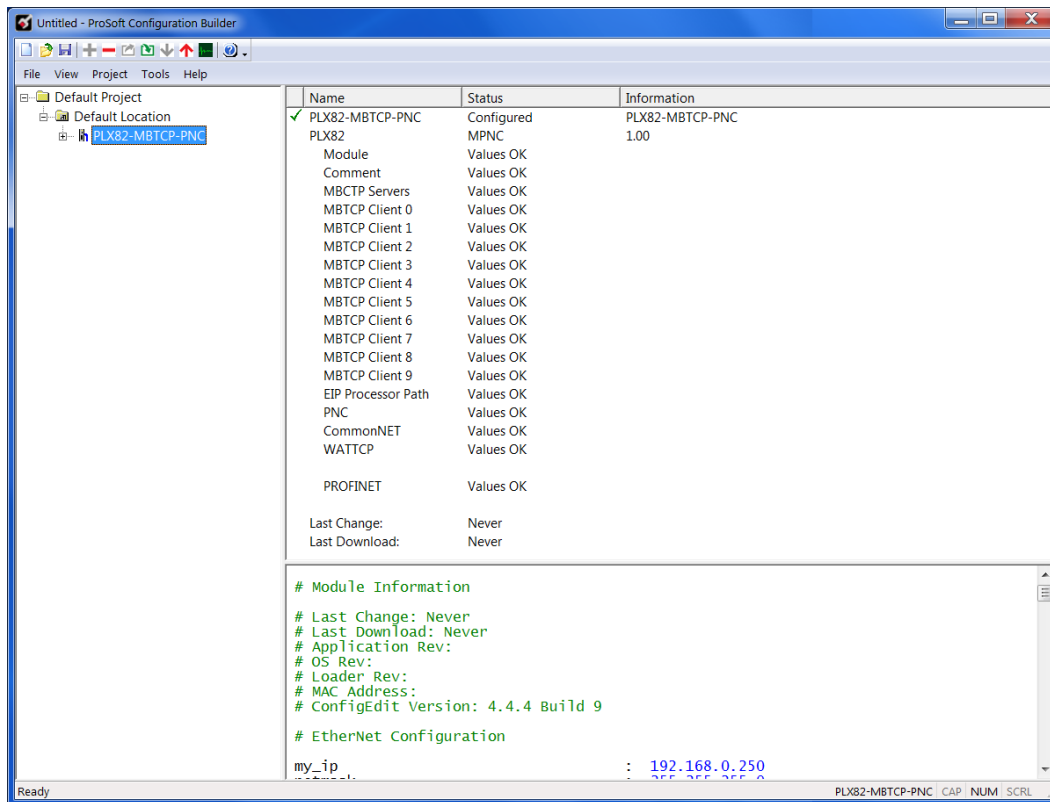

2.2 Setting a Project Name (Optional)

The project name is initially set to "Default Location".

- 1 Right click on the **DEFAULT LOCATION** icon and select **RENAME**.

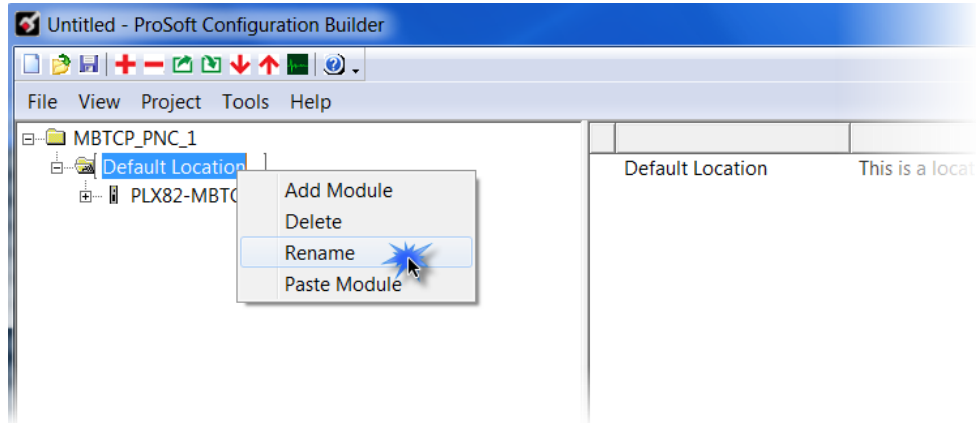

- 2 Type in a name for your project and press **ENTER**.

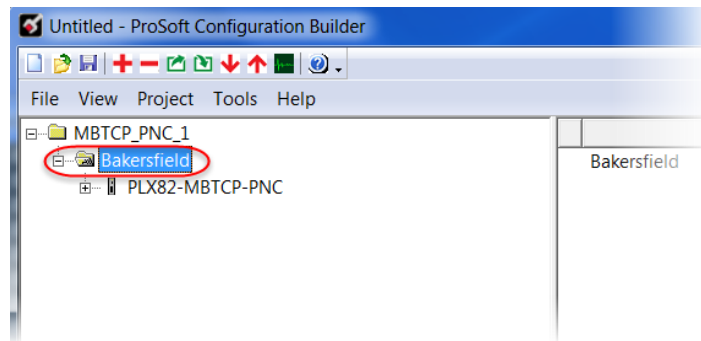

2.3 Setting a Temporary IP Address

Important: ProSoft Discovery Service (PDS) is a built-in utility within PCB. It locates the PLX82-MBTCP-PNC through UDP broadcast messages. These messages may be blocked by routers or layer 3 switches. In that case, PDS is unable to locate the PLX82-MBTCP-PNC.

To use PDS, arrange the Ethernet connection so that there is no router or layer 3 switch between the computer and the PLX82-MBTCP-PNC, or reconfigure the router or layer 3 switch to allow the routing of the UDP broadcast messages.

- 1 Right-click the **PLX82-MBTCP-PNC** icon and select **DIAGNOSTICS**.

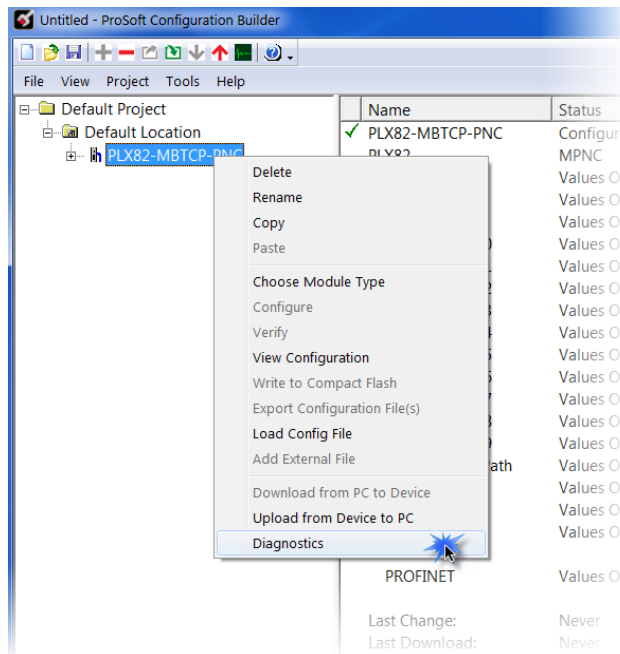

- 2 When the *Diagnostics* dialog opens, click on the **SETUP CONNECTION** icon.

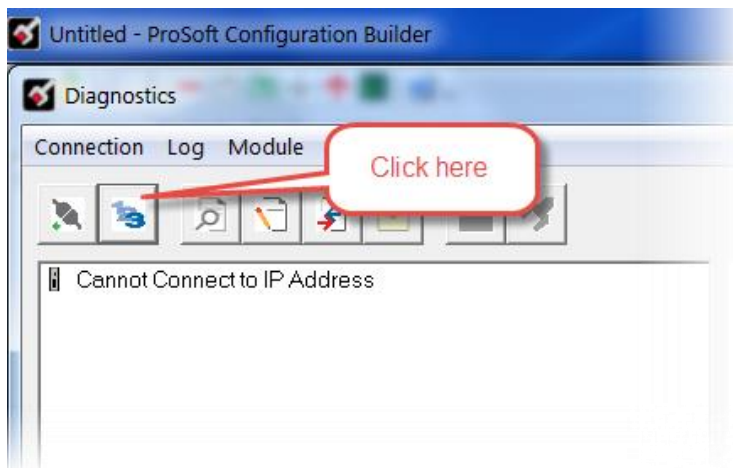

- When the *Connection Setup* dialog opens, click the **BROWSE DEVICES** button to locate your device.

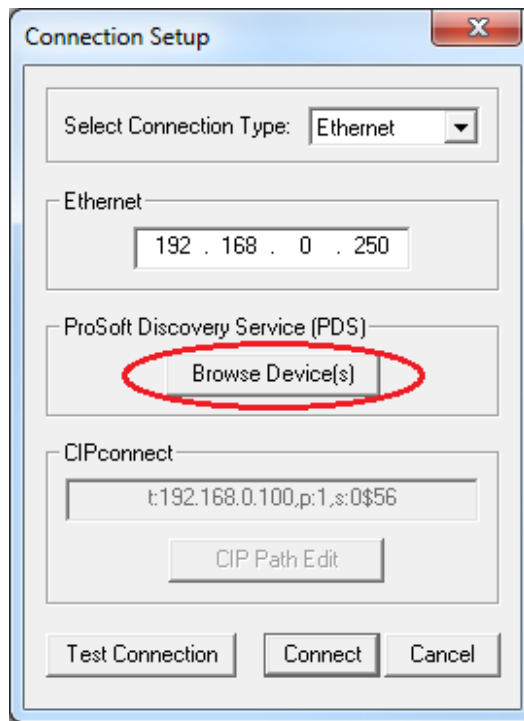

- PDS displays the ProSoft modules that have been detected on the network. Right-click on the PLX82-MBTCP-PNC, and then click **ASSIGN TEMPORARY IP**.

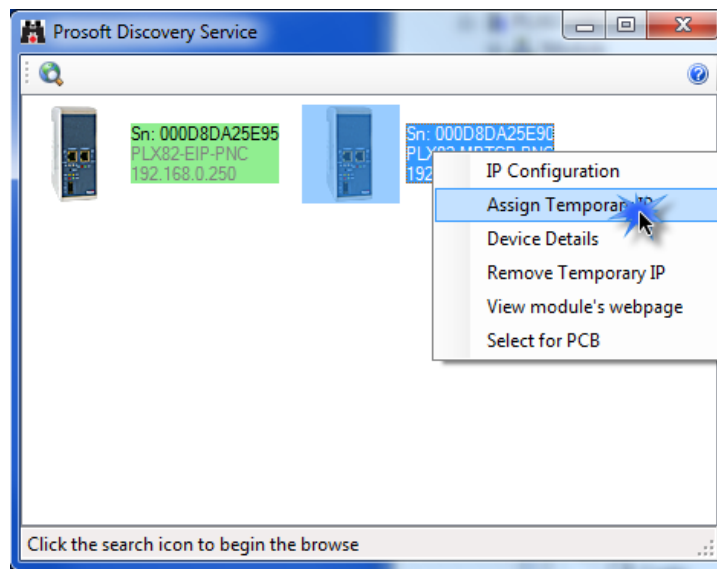

- The module's default IP address is **192.168.0.250**.

- 6 Enter an unused IP within your subnet, and then click **OK**.

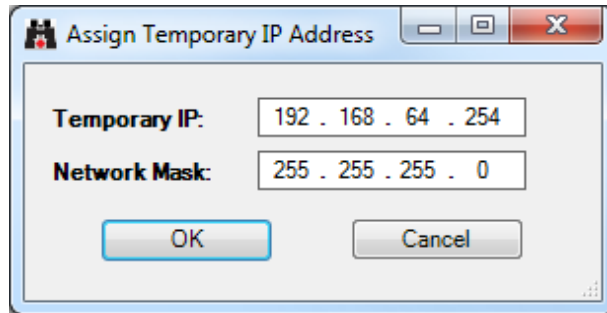

2.4 Saving the Project

The PCB project must be saved when you move from PCB to ProSoft fdt Configuration Manager if you have not previously saved the project while in PCB.

- 1 Navigate to **FILE > SAVE AS**.
- 2 Select the appropriate directory and filename name of your ProSoft Project File (PPF).
- 3 Click **SAVE**.

2.5 Downloading the Configuration File to the PLX82-MBTCP-PNC

After you have created the project in the ProSoft Configuration Builder and configured the PROFINET controller (Chapter 4, page 35) in ProSoft fdt Configuration Manager software, you are ready to download it to the PLX82-MBTCP-PNC.

Warning: Prior to downloading the project with PCB, you must first save the project, then open ProSoft fdt Configuration Manager by double-clicking on “PROFINET” in the project tree of PCB. This process builds the necessary files and folders for the PROFINET configuration. When creating a new project, failure to open ProSoft fdt Configuration Manager prior to downloading will result in an error since the required files and folders have not been created for this project.

Example: Project folder **before** ProSoft fdt Configuration Manager is opened.

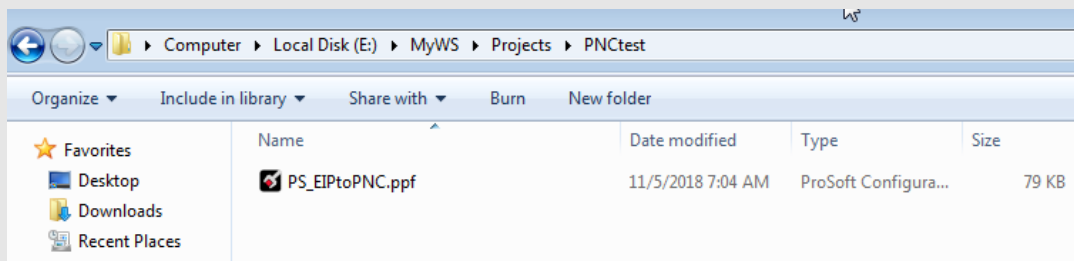

Example: Project folder **after** ProSoft fdt Configuration Manager is opened.

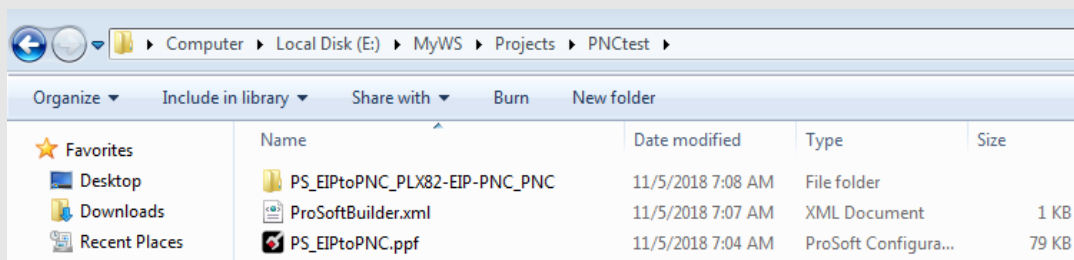

- 1 From PCB, right-click on the **PLX82-MBTCP-PNC** icon and select **DOWNLOAD FROM PC TO DEVICE**.

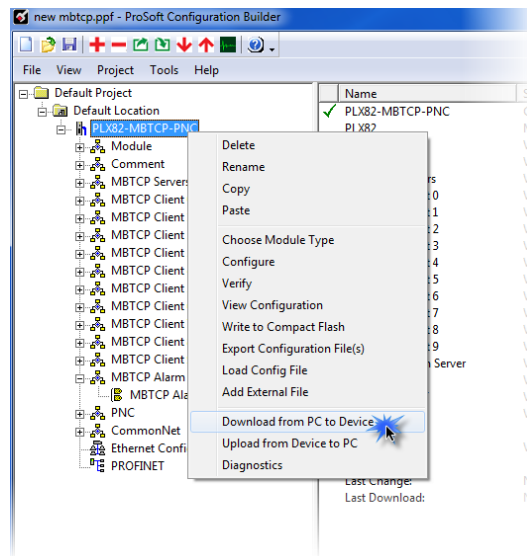

- 2 The *Download files from PC to module* dialog box opens:

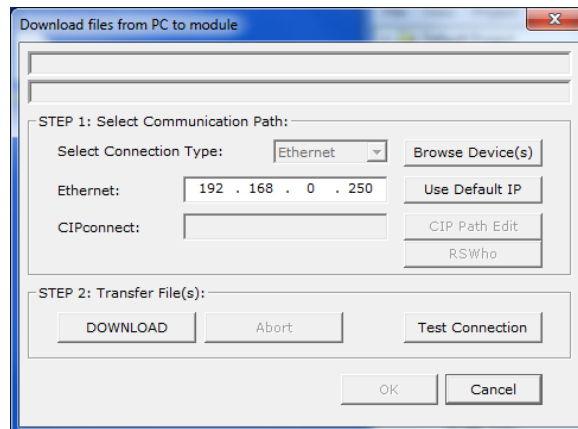

- 3 Click **TEST CONNECTION**.

If the PLX82-MBTCP-PNC's IP address matches the address in the Configuration Manager, and the software displays the following message: "*Successfully connected.*"

If the PLX82-MBTCP-PNC's IP address does not match what was entered in PCB, then the software displays an error message: "*Error: Connecting to Module. Please check your IP Address.*"

- 4 Click **DOWNLOAD** to download the project to the PLX82-MBTCP-PNC.

2.6 Uploading the Configuration from the PLX82-MBTCP-PNC

Use this feature to retrieve the configuration from the PLX82-MBTCP-PNC. Not only does it retrieve the configuration, but it also retrieves all related files used in creating that configuration. There are several reasons that you might use this feature:

- You want to modify the configuration, but do not have access to the original configuration files.
- You want to copy a configuration from one PLX82-MBTCP-PNC to another PLX82-MBTCP-PNC.
- You want to back up the configuration for safety.

Warning: This function replaces the current configuration in the PCB with the one from the PLX82-MBTCP-PNC. Make sure you save the current configuration before uploading the configuration from the PLX82-MBTCP-PNC.

- 1 **Optional:** Create a new project in the PCB by choosing **FILE > NEW**.
- 2 Right-click the PLX82-MBTCP-PNC icon and choose **UPLOAD FROM DEVICE TO PC**.

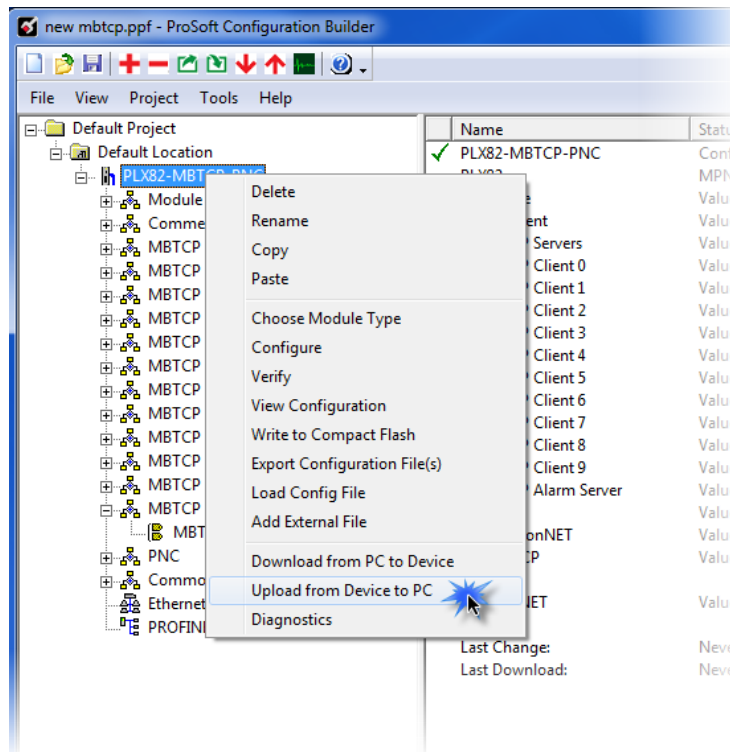

3 The *Upload files from Module to PC* dialog box opens:

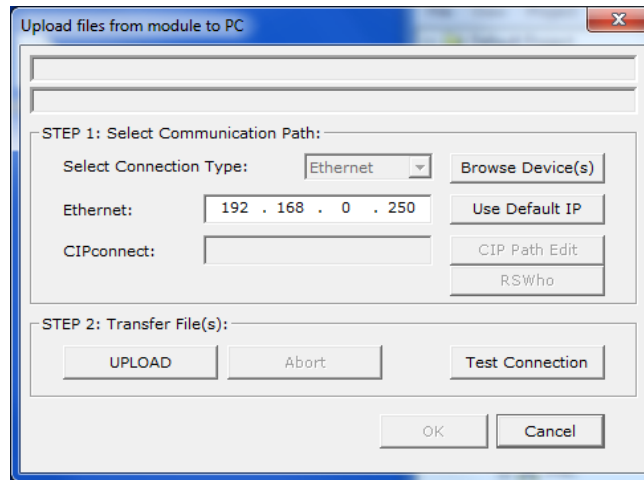

- 4 Select the *Connection Type*. If you don't know the IP address of the module that contains the configuration that you want, you can browse devices using the **BROWSE DEVICE(S)** button. This launches the ProSoft Discovery Service application.
- 5 Enter the IP address of the PLX82-MBTCP-PNC. All PLX82-MBTCP-PNC's are shipped with a default IP address **192.168.0.250**. Click the **USE DEFAULT IP** button to use the default address.
- 6 Use the **TEST CONNECTION** button to ensure that the connection is good.
- 7 Click the **UPLOAD** button to start the upload.
- 8 When the upload is complete, the configuration is displayed in PCB. You can edit or save it on the PC.

2.7 Exporting a Project

You can export a PCB file that was created on your PC. This allows someone on a different PC to import your configuration file and have all the files that are part of your project. If you need assistance from ProSoft Technology Technical Support, they will need your exported files.

- 1 In the PCB choose **PROJECT > MODULE > EXPORT CONFIGURATION FILES**.
- 2 In the *Save As* dialog box, navigate to the correct directory and save the configuration file.

2.8 Writing the Project to Compact Flash

This procedure describes how to save a project from a PC to a Compact Flash drive.

- 1 From PCB, navigate to **PROJECT > MODULE > WRITE TO COMPACT FLASH**.

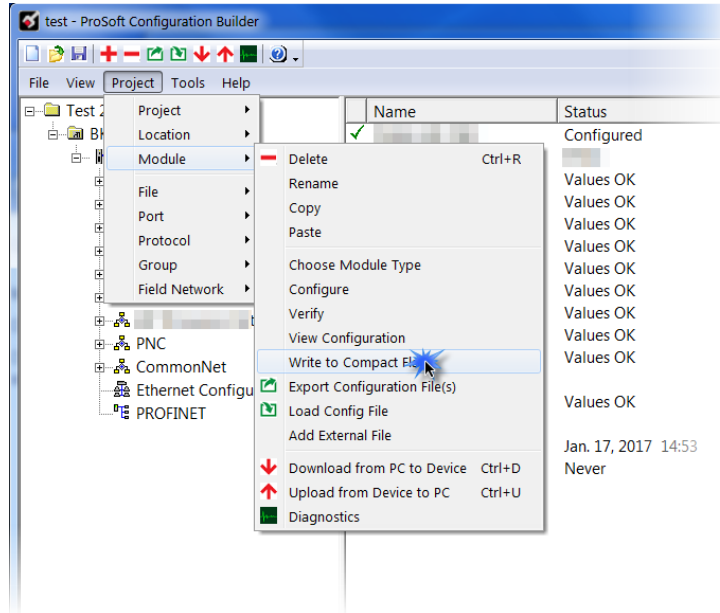

- 2 Choose the appropriate drive, then click **NEXT**.

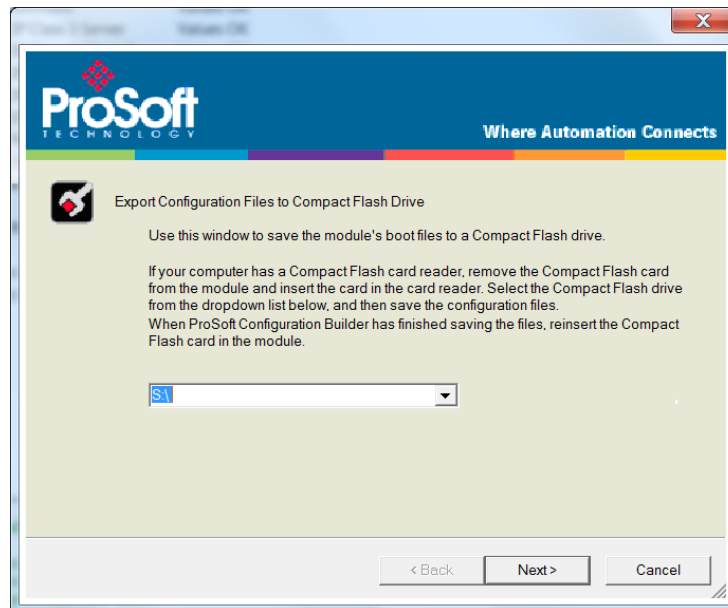

- 3 Follow the on-screen instructions and click **FINISH** when complete.

3 Configuring Modbus TCP/IP

Use the MBTCP protocol to communicate to remote Modbus TCP/IP client and server devices.

The PLX82-MBTCP-PNC supports a client connection on the TCP/IP network to interface with processors (and other server-based devices) using a command list of up to 100 entries. The PLX82-MBTCP-PNC's internal database is used as the source for write commands to remote devices. The internal database also shares space for incoming data from remote devices using read commands.

Data in the PLX82-MBTCP-PNC's internal database is accessible for read and write operations by any node on the network supporting the MBAP (Service Port 502) or MBTCP (Service Ports 2000/2001) TCP/IP protocols. The MBAP protocol (Port 502) is a standard implementation defined by Schneider Electric and used on the Quantum processor. This open protocol is a modified version of the Modbus serial protocol. The MBTCP protocol is an embedded Modbus protocol message in a TCP/IP packet. The PLX82-MBTCP-PNC supports up to five active server connections on Service Port 502, five additional active server connections on Service port 2000, and one active client connection.

3.1 Configuring MBTCP Servers

This section contains database offset information used by the Modbus TCP/IP server when accessed by external Modbus TCP/IP clients. You can use these offsets to segment the database by data type.

Note: If you will only be using the PLX82-MBTCP-PNC as a Modbus TCP/IP client, and will not be having any Modbus TCP/IP clients connecting to the module, you can skip this section and proceed to the next section.

- 1 Click on **PLX82-MBTCP-PNC > MBTCP SERVERS > MBTCP SERVERS**.

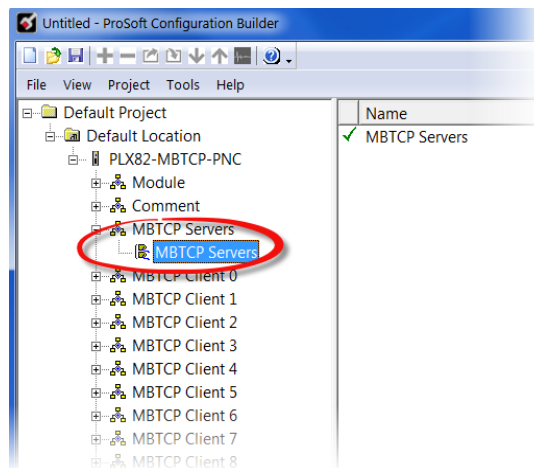

- 2 Double-click the second **MBTCP SERVERS** icon to display the *Edit - MBTCP Servers* dialog box.

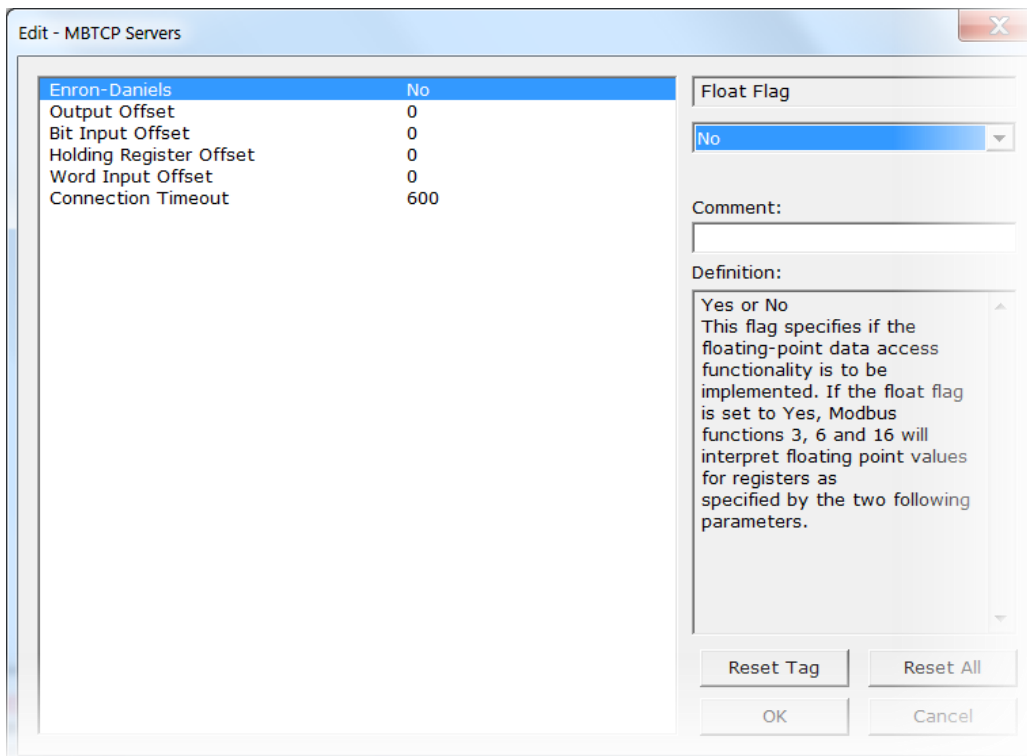

- 3 In the dialog box, enter a value for each parameter. Note that the *Float Start* and *Float Offset* parameters are only visible if you set *Enron Daniels* to **YES**.

About Enron Daniels Mode

Earlier ProSoft Technology Modbus products had a feature called *float flag*. This feature has been renamed to *Enron Daniels* mode in most of the newer Modbus products to avoid the misconception that this mode was necessary for accessing floating-point values in non-Enron or Daniels devices.

While floating-point values can be read or written in standard Modbus devices without the need to enable this mode, most Enron or Daniels devices are programmed such that, when reading their floating-point data (commonly in the 7001 and above range) the count field is assumed to be the number of floats to be read or written, not the number of registers as usual.

For example, if you attempt to read from address 7001 with a count of 2, you would actually get four registers returned (two 32-bit floating values) instead of the usual two 16 bit registers. Many of our products can actually read Enron or Daniels floating-points with even enabling the mode because even if we ask for 4 registers, and they return 8, we will take what they give us rather than reject the message. However, when writing to an Enron or Daniels device, the mode is almost always essential, as most Enron or Daniels devices will reject our write attempt if we tell them to expect 2, and only give them 2 registers instead of 4.

Parameter	Value	Description
Enron Daniels	Yes or No	Specifies if the floating point data access functionality is to be implemented. If the <i>Enron Daniels</i> parameter is set to YES , Modbus functions 3, 6, and 16 will interpret floating point values for registers as specified by the two following parameters.
Output Offset	0 to 9999	This parameter defines the start register for the Modbus command data in the internal database. This parameter is enabled when a value greater than 0 is set. For example, if the <i>Output Offset</i> value is set to 3000, data requests for Modbus coil register address 00001 will use the internal database register 3000, bit 0. If the <i>Output Offset</i> value is set to 3000, data requests for Modbus Coil register address 00016 will use the internal database register 3000, bit 15. Function codes affected are 1, 5, 15.
Bit Input Offset	0 to 9999	0 to 9999 This parameter defines the start register for Modbus Command data in the internal database. This parameter is enabled when a value greater than 0 is set. For example, if the <i>Bit Input Offset</i> value is set to 3000, data requests for Modbus Input register 10001 will use the internal database register 3000, bit 0. If the <i>Bit Input Offset</i> value is set to 3000, data requests for Modbus Coil register address 10016 will use the internal database register 3000, bit 15. Function code affected is 2.
Holding Register Offset	0 to 9999	0 to 9999 This parameter defines the start register for Modbus Command data in the internal database. This parameter is enabled when a value greater than 0 is set. For example, if the <i>Holding Register Offset</i> value is set to 3000, data requests for Modbus Word register address 40001 will use the internal database register 3000. Function codes affected are 3, 6, and 23.
Word Input Offset	0 to 9999	This parameter defines the start register for Modbus command data in the internal database. This parameter is enabled when a value greater than 0 is set. For example, if the <i>Word Input Offset</i> value is set to 3000, data requests for Modbus Word register address 30002 will use the internal database register 3000. Function code affected is 4.
Connection Timeout	0 to 1200	Defines how many seconds of inactivity the PLX82-MBTCP-PNC allows between data transfers with a Modbus client before it determines that communication with the Modbus client is lost and thus, closes the connection.

3.2 Configuring MBTCP Client [x]

Use this section if you need to initiate communications with one or more Modbus TCP/IP Server devices. If you are communicating with multiple Modbus TCP/IP servers, ProSoft recommends that you use a separate MBTCP client for each server. The module supports a maximum of 10 separate client connections. However, if you need to communicate with more than 10 servers, it is possible to create commands to multiple servers for a single client. You must be aware that in order to do so, your servers must support frequent opening and closing of their server connections and communication update rates will be dramatically reduced in comparison to having a dedicated client per server.

The *MBTCP Client[x]* section specifies the parameters for each MBTCP client on the PLX82-MBTCP-PNC. The MBTCP command list configuration is covered in the next section.

- 1 Click on **PLX82-MBTCP-PNC > MBTCP CLIENT [x] > MBTCP CLIENT [x]**.

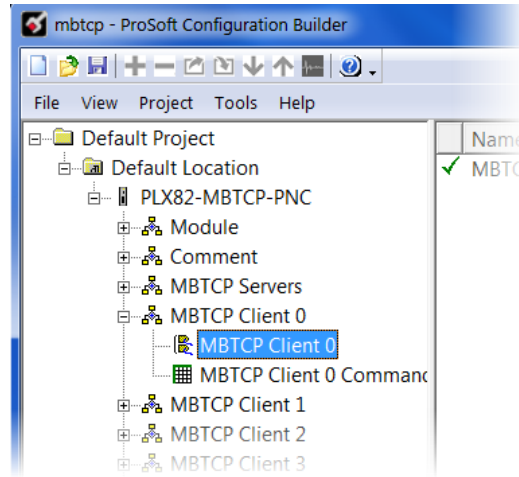

- 2 Double-click the second **MBTCP CLIENT [x]** icon to display the *Edit - MBTCP Client [x]* dialog box.

- In the dialog box, enter a value for the parameter. Note that the *Float Start* and *Float Offset* parameters only appear if *Enron-Daniels* is set to **YES**.

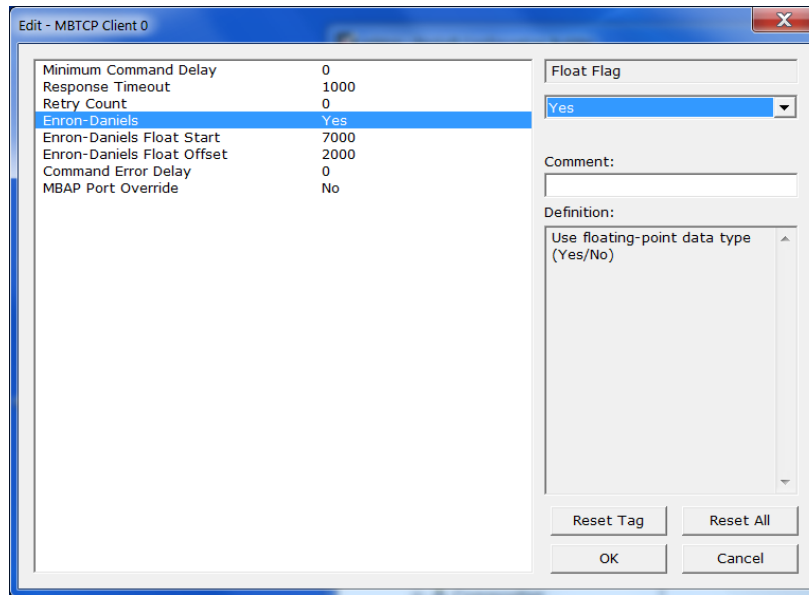

Parameter	Value	Description
Minimum Command Delay	0 to 65535	Specifies the number of milliseconds to wait between the initial issuance of a command. You can use this to delay all commands sent to slaves to avoid "flooding" commands on the network. This parameter does not affect retries of a command as they will be issued when failure is recognized. Regardless of what number is used for this parameter, if the optional retry feature for this client is enabled (number greater than zero), all retries are attempted without delay.
Response Timeout	0 to 65535	Specifies the time in milliseconds that a client waits before re-transmitting a command if no response is received from the addressed server. The current default value works for most applications. However, the ideal value for this parameter may require alteration based on the type of communication network that the PLX82-MBTCP-PNC is used in, and the expected response time of the slowest device on the network. For example, if we are not communicating directly with a Modbus TCP/IP device, but rather through a Modbus TCP/IP to Modbus Serial Converter to a Modbus Serial device, a longer response time may be required.
Retry Count	0 to 10	Specifies the number of times the PLX82-MBTCP-PNC retries a command if it fails.
Enron Daniels	Yes or No	Specifies if the floating-point data access functionality is active. Yes - Modbus functions 3, 6, and 16 interpret floating-point values for registers as specified by Float Start and Float Offset. No - The PLX82-MBTCP-PNC does not use floating-point functionality.

Parameter	Value	Description
Enron Daniels Float Start	0 to 32767	This parameter only appears if Enron Daniels is set to YES . Specifies the first register of floating-point data. The PLX82-MBTCP-PNC considers all requests with register values great than or equal to this value as floating-point data requests. For example, if you enter 7000, the PLX82-MBTCP-PNC considers all requests for registers 7000 and above as floating-point data.
Enron-Daniels Float Offset	0 to 9998	This parameter only appears if <i>Enron Daniels</i> is set to YES . Specifies the starting register for floating-point data in the PLX82-MBTCP-PNC internal database. For example, If you set Float Offset to 3000 and set Float Start to 7000, the PLX82-MBTCP-PNC returns data as floating-point data for register 47001 (or 407001) actually comes from internal PLX82-MBTCP-PNC registers 3000 and 3001. If the requested address is 47002 (407002), the PLX82-MBTCP-PNC returns data from internal registers 3200 and 3201, and so on.
Command Error Delay	0 to 300	Specifies the number of 100 millisecond intervals to turn off a command in the error list after an error is recognized for the command. If you set this to zero, there is no delay.
MBAP Port Override	Yes or No	Specifies whether to override the default port settings. Yes - The PLX82-MBTCP-PNC uses MBAP format messages for all Server Port values. The PLX82-MBTCP-PNC does not use RTU through TCP. No - The PLX82-MBTCP-PNC uses standard Server Port 502 with MBAP format messages. All other Server Port values use encapsulated Modbus message format (RTU through TCP).

3.2.1 Configuring MBTCP Client [x] Commands

The MBTCP Client [x] Commands section defines the Modbus TCP/IP commands to be issued from the PLX82-MBTCP-PNC to Modbus TCP/IP servers on the network. You can use these commands for data collection and/or control of devices on the Modbus TCP/IP network.

The commands in the list specify the server device to be addressed, the function to be performed (read or write), the data in the device to interface with and the registers in the internal database to be associated with device data. The client command list supports up to 16 commands per client. The gateway processes the commands list from top (command #0) to bottom.

- 1 Click on **PLX82-MBTCP-PNC > MBTCP CLIENT [x] > MBTCP CLIENT [x] COMMANDS**.

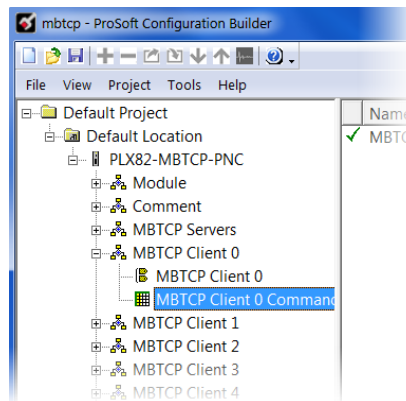

- 2 Double-click on the **MBTCP CLIENT [x] COMMANDS** icon to display the *Edit - MBTCP Client [x] Commands* dialog box.

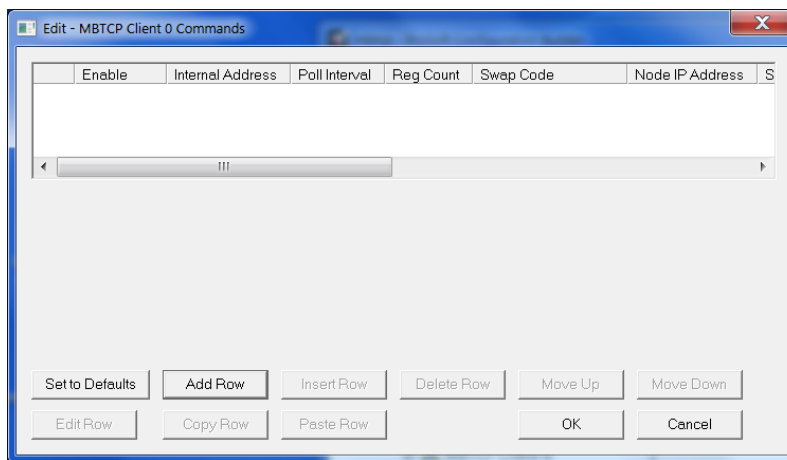

- In the dialog box, click **ADD ROW** to add a command, then click **EDIT ROW** to enter values for the command.

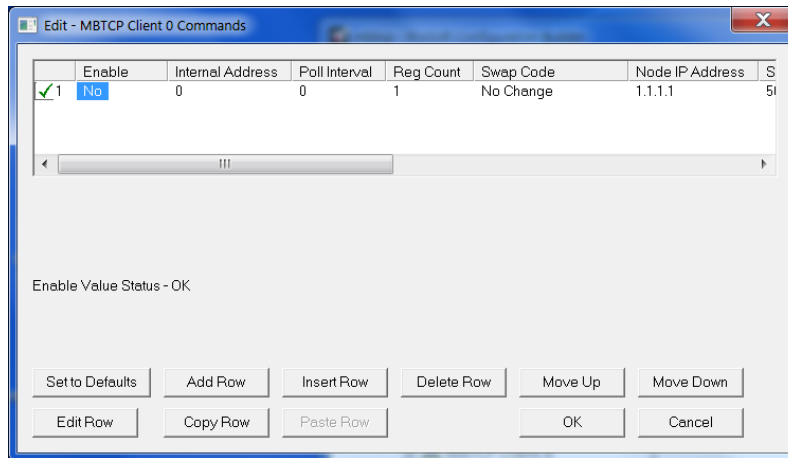

The following table describes the command list configuration parameters:

Parameter	Value	Description
Enable	YES NO CONDITIONAL	Specifies if the command is to be executed and under what conditions. No (0) - the command is disabled and it not executed in the normal polling sequence. Yes (1) - the command is executed upon each scan of the Command List if the Poll Interval is set to zero (0). If the Poll Interval is set to a non-zero value, the command is executed when the interval timer for that command expires. Conditional (2) - the command is executed only if the internal data associated with the command changes. This parameter is valid for write commands (FC 5,6,15 and 16).
Internal Address	0 to 9999 (for register-level addressing) or 0 to 159999 (for bit-level addressing)	Specifies the database address in the gateway's internal database to use as the destination for data from a read command, or as the source for data sent by a write command. The database address is interpreted as a bit address or a 16-bit register (word) address, depending on the Modbus Function Code used in the command. For Modbus functions 1, 2, 5, and 15, this parameter is interpreted as a bit-level address. For Modbus functions 3, 4, 6, and 16, this parameter is interpreted as a register-level address.

Parameter	Value	Description
Poll Interval	0 to 65535	<p>Specifies the minimum interval between executions of continuous commands. The value is in tenths of a second. If you enter a value of 100, the command executes no more frequently than once every 10 seconds. Unlike the minimum command delay, if the poll interval for a command has not passed, instead of simply waiting, the module moves on to the next command and returns to that command later.</p> <p>Because of this, this parameter can be useful if you have commands that do not need to execute as frequently as others. By increasing the poll interval for these lower-priority commands, you indirectly increase the update rate of your higher priority commands. If all commands are of the same priority, but you need to poll another device slower, ProSoft recommends keeping this value at zero and increasing the client's Minimum Command Delay instead.</p>
Reg Count	1 to 125 (for registers) or 1 to 800 (for coils)	<p>Specifies the number of 16-bit registers or binary bits to be transferred by the command.</p> <p>Modbus functions 5 and 6 ignore this field as they apply only to a single data point.</p> <p>For Modbus functions 1, 2, and 15, this parameter sets the number of bits (inputs or coils) transferred by the command.</p> <p>For Modbus functions 3, 4, and 16, this parameter sets the number of registers transferred by the command.</p>
Swap Code	No Change Word Swap Word and Byte Swap Byte Swap	<p>Specifies if and how the order of bytes in data received or sent is to be rearranged. Different manufacturers store and transmit multi-byte data in different combinations. You can use this parameter when dealing with floating-point or other multi-byte values, as there is not a standard method of storing these data types. You can set this parameter to rearrange the byte order of data received or sent into an order more useful or convenient for other applications.</p> <p>No change (0) - No change is made in the byte ordering (1234 = 1234).</p> <p>Word Swap (1) - The words are swapped (1234 = 3412).</p> <p>Word and Byte Swap (2) - The words are swapped, then the bytes in each word are swapped (1234 = 4321).</p> <p>Byte Swap (3) - The bytes in each word are swapped (1234 = 2143).</p> <p>These swap operations affect 4-byte (2-word) groups of data. Therefore, data swapping using Swap Codes should be done only when using an even number of words, such as 32-bit integer or floating point data.</p>
Node IP Address	xxx.xxx.xxx.xxx	IP address of the device being addressed by the command.
Serv Port	502 or other supported port on server	<p>Service Port on which communication will occur. Use a value of 502 when addressing Modbus TCP/IP servers that are compatible with Schneider Electric MBAP specifications (this will be most devices). If the service device supports another Service Port, enter the Service Port value for this parameter.</p> <p>Using a non-502 port changes the way the module communicates (uses encapsulated Modbus) unless MBAP Override is enabled.</p>

Parameter	Value	Description
Slave Address	1 to 255 (0 is a broadcast)	<p>Specifies the node address of a remote Modbus Serial device through a Modbus Ethernet to Serial converter. If communicating directly with a Modbus TCP/IP device, this field is typically ignored. If no slave address is specifically requested by the end device, it is recommended that this setting be left at 1.</p> <p>Note: Most Modbus devices only accept addresses in the range of 1 to 247, so check with the slave device manufacturer to see if the slave device can use addresses 248 to 255.</p> <p>If the value is set to zero, the command will be a broadcast message on the network. The Modbus protocol permits broadcast commands for write operations. Do not use node address 0 for read operations.</p>
Modbus Function	1, 2, 3, 4, 5, 6, 15, or 16	<p>Specifies the Modbus function code to be executed by the command. These function codes are defined in the Modbus protocol. More information on the protocol is available from www.modbus.org or see About the Modbus Protocol. The following function codes are supported by the gateway:</p> <ul style="list-style-type: none"> 1 - Read Coil Status 2 - Read Input Status 3 - Read Holding Registers 4 - Read Input Registers 5 - Force (Write) Single Coil 6 - Preset (Write) Single Register 15 - Force Multiple Coils 16 - Preset Multiple Registers

Parameter	Value	Description
MB Address in Device	Varies	<p>Specifies the starting Modbus register or bit address in the server to be used by the command. Refer to the documentation of each Modbus server device for the register and bit address assignments valid for that device.</p> <p>The Modbus Function Code determines whether the address is a register-level or bit-level OFFSET address into a given data type range. The offset is the target data address in the server, minus the base address for that data type. Base addresses for the different data types are:</p> <p>00001 or 000001 (0x0001) for bit-level Coil data (Function Codes 1, 5, and 15).</p> <p>10001 or 100001 (1x0001) for bit-level Input Status data (Function Code 2)</p> <p>30001 or 300001 (3x0001) for Input Register data (Function Code 4)</p> <p>40001 or 400001 (4x0001) for Holding Register data (Function Codes 3, 6, and 16).</p> <p><i>Address calculation examples:</i></p> <p>For bit-level Coil commands (FC 1, 5, or 15) to read or write a Coil 0X address 00001, specify a value of 0 (00001 - 00001 = 0)</p> <p>For Coil address 00115, specify 114 (00115 - 00001 = 114)</p> <p>For register read or write commands (FC 3, 6, or 16) 4X range, for 400001, specify a value of 0 (40001 - 40001 = 0).</p> <p>For 01101, 11101, 31101, or 41101, specify a value of 1100.</p> <p>(01101 - 00011 = 1100)</p> <p>(11101 - 10001 = 1100)</p> <p>(31101 - 20001 = 1100)</p> <p>Note: If the documentation for a particular Modbus server device lists data addresses in hexadecimal (base 16) notation, you must convert the hexadecimal value to a decimal value for this parameter. In such cases, it is not usually necessary to subtract 1 from the converted decimal number, as this addressing scheme typically uses the exact offset address expressed as a hexadecimal number.</p>
Comment		Optional 32 character comment for the command.

3.3 Configuring the MBTCP Remote Servers

Configuring the MBTCP Remote Servers specifies where PROFINET acyclic command responses and alarm information is stored for a specified Modbus TCP/IP server.

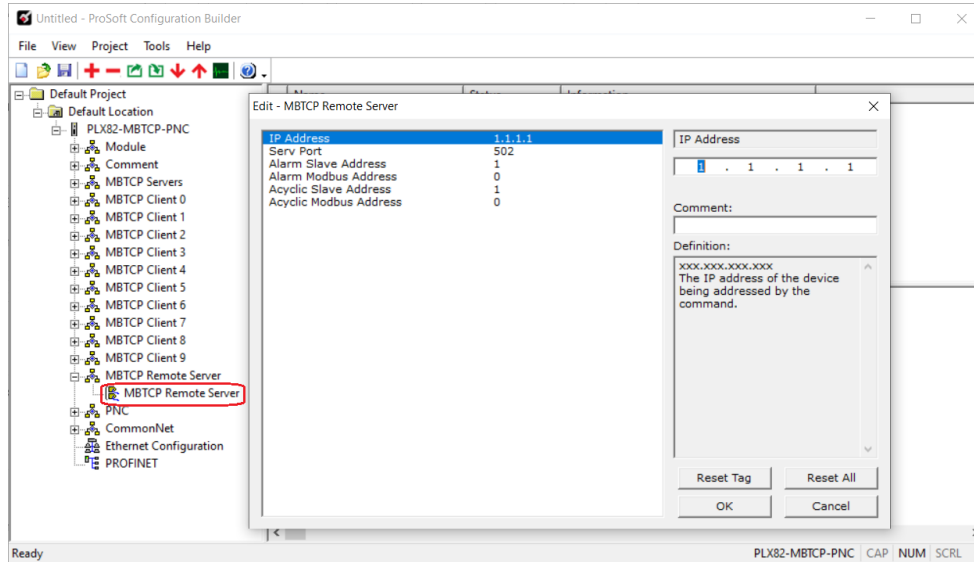

Parameter	Description
IP Address	Enter the IP address of the Modbus TCP/IP server that will receive the PROFINET acyclic responses and alarm information.
Serv Port	Port 502 or other supported ports on server command. Use a value of 502 when addressing Modbus TCP/IP servers which are compatible with the Schneider Electric MBAP specifications (most devices). If a server implementation supports another service port, enter the value here.
Alarm Slave Address	1 to 255. Specifies the Modbus slave node address on the network that the PROFINET alarm information will be written to. Most Modbus devices only accept an address in the range of 1 to 247 so use caution. If the value is set to 0, the command will be a broadcast message on the network. The Modbus protocol permits broadcast commands for write operations.
Alarm Modbus Address	Specifies the starting Modbus register to place alarm info.
Acyclic Slave Address	1 to 255. This parameter specifies the Modbus slave node address on the network that will receive the PROFINET acyclic response information. Most Modbus devices only accept an address in the range of 1 to 247 so use caution. If the value is set to 0, the command will be a broadcast message on the network. The Modbus protocol permits broadcast commands for write operations. Do not use this node for Read operations.
Acyclic Modbus Address	Specifies the starting Modbus register to place acyclic responses from the PROFINET device.

3.4 MBTCP Port IP Address Configuration

This IP address configuration is for the MBTCP port only. The IP address configuration of the PNC port is done using ProSoft fdt Configuration Manager.

Sets the IP address of the MBTCP driver only. The PNC driver IP address is set within ProSoft fdt Configuration Manager.



This port is used for configuration downloads, diagnostics, and Modbus TCP/IP communications. The default is initially set to 192.168.0.250.

1 Click on **PLX82-MBTCP-PNC > ETHERNET CONFIGURATION.**

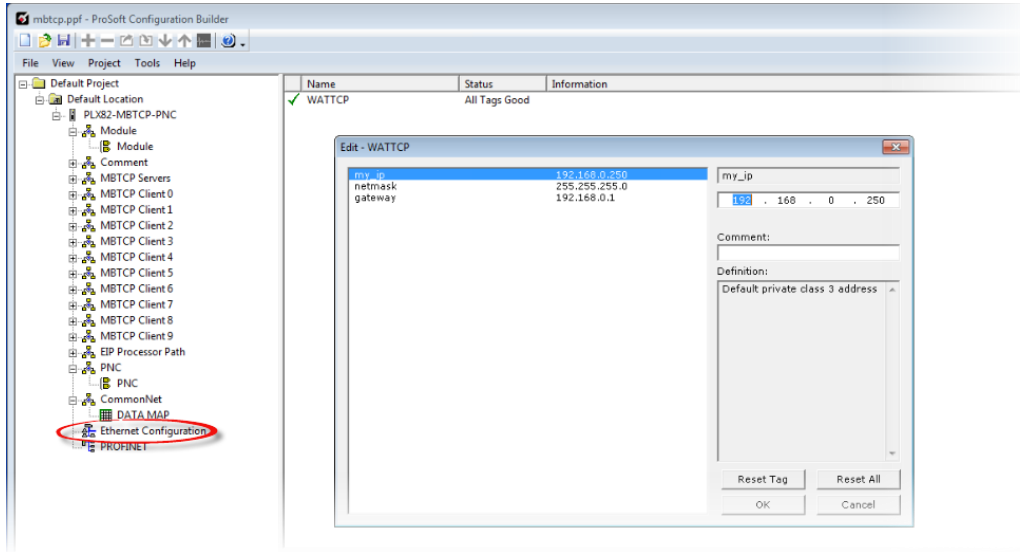

- 2 Select **MY_IP** and enter the IP address of the PLX82-MBTCP-PNC.
- 3 Select **NETMASK** and enter the network mask.
- 4 If necessary (e.g., you are using a router), select **GATEWAY** and enter the IP address of the network gateway (router). Otherwise, enter 0.0.0.0.
- 5 Click **OK** when done.

4 Configuring the PROFINET Controller

Note: ProSoft fdt Configuration Software incorrectly allows for up to 36 PROFINET devices to be configured with an "Update rate" as low as 1ms. Since that configuration can produce over 70,000 frames per second, the PROFINET controller and devices will experience errors. ProSoft Technology is in the process of adding limitations to the configuration software, and until then, we have produced a guideline document to aid in the proper configuration of the PROFINET controller. This guideline is available from the ProSoft website, accessible from the PLX82-MBTCP-PNC product page. The file is named "ProSoft-PROFINET-Net-Load-Calculator+v4.xlsx.

4.1 PNC Controller Network Settings

This section identifies the PLX82-MBTCP-PNC PROFINET Controller on the PROFINET network.

- 1 From the PCB window, double-click on the **PROFINET** icon.

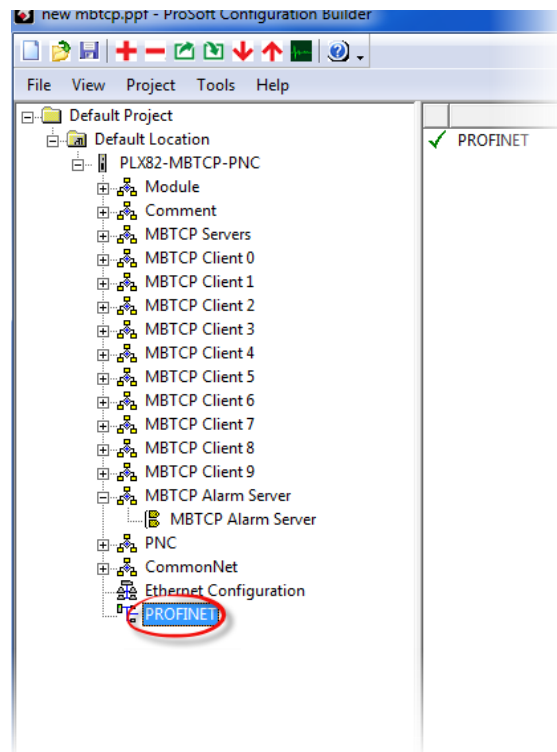

Note: If you have not already saved the project file, you are prompted to do so before you can proceed.

- 2 This opens the *Network* window.

- 3 Double-click on the **PLX82-MBTCP-PNC** icon in the *Network* pane.

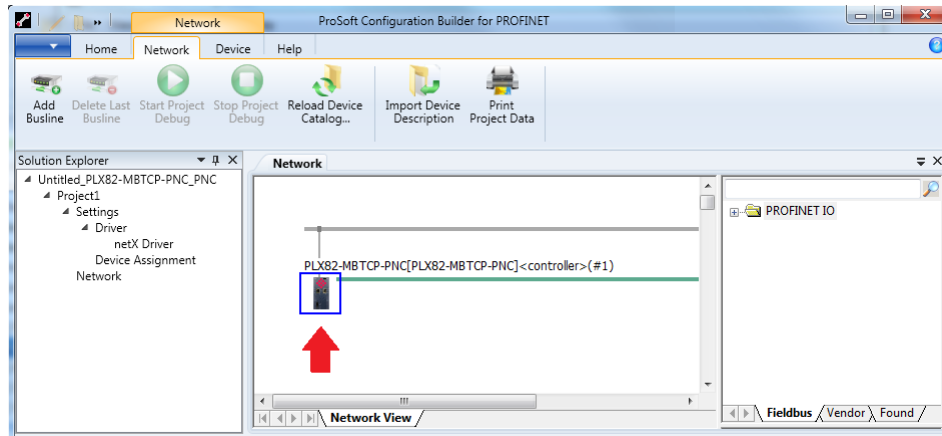

- 4 This opens the *Controller Network Settings* window.

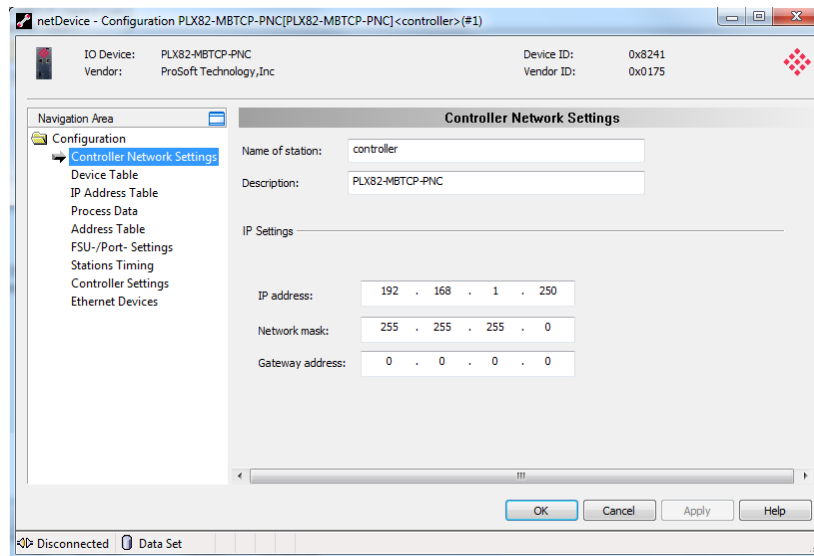

- 5 In the *Navigation Area* pane, click on *Controller Network Settings*.
- 6 Enter the station name, provide a description, and set the IP address of the PROFINET Controller.
The station name is used to uniquely identify the controller on the PROFINET network. The default name is "controller". If you have multiple controllers on multiple networks, the *Name of Station* parameter helps to identify various controllers that may be displayed as a result of a network device scan.
- 7 When complete, click **OK**.

4.2 Importing GSD Files

PROFINET Device information files (typically GSD or GSDML) must be imported for all devices you intend to connect to through the PLX82-MBTCP-PNC. GSD and GSDML files are available from the PROFINET device manufacturer.

Important:

- For devices with GSDML XML Schema version 1.0, every module has one submodule assigned. No additional submodules can be added, and the assigned submodule cannot be removed.
- For devices with GSDML XML Schema version 2.0, you can configure the submodules, and these submodules can be added or removed from the corresponding module.
- The GSDML file differentiates between **fixed in slot**, **used in slot**, and **allowed in slot** modules. *Fixed in slot* and *Used in slot* modules are automatically configured. **Allowed in slot** modules can be configured.

- 1 Click on the **NETWORK** tab and then click on the **IMPORT DEVICE DESCRIPTION** icon.

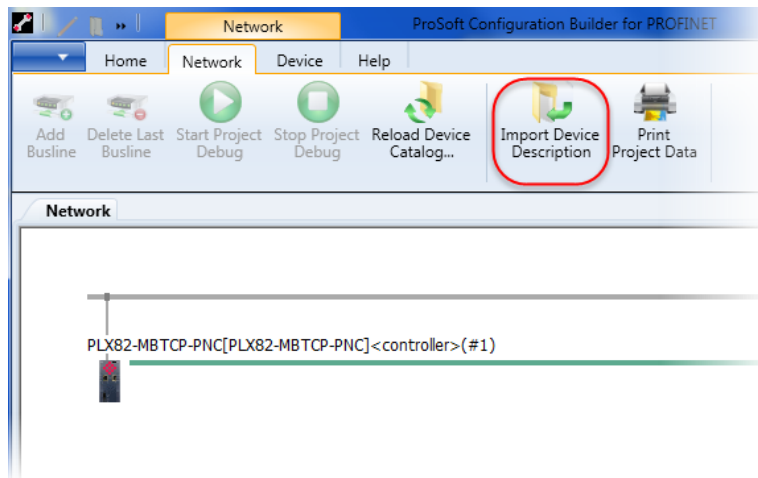

- 2 Navigate to the location of your GSD or GSDML files and select the appropriate files for your devices.

- 3 Click **OPEN** and then click **YES**. The GSD file is displayed in the right pane of the window.

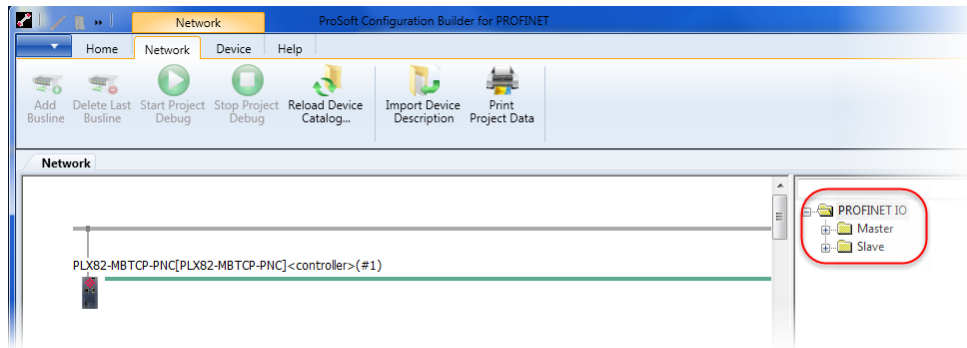

- 4 Open the device folder to display the slave device icon(s).

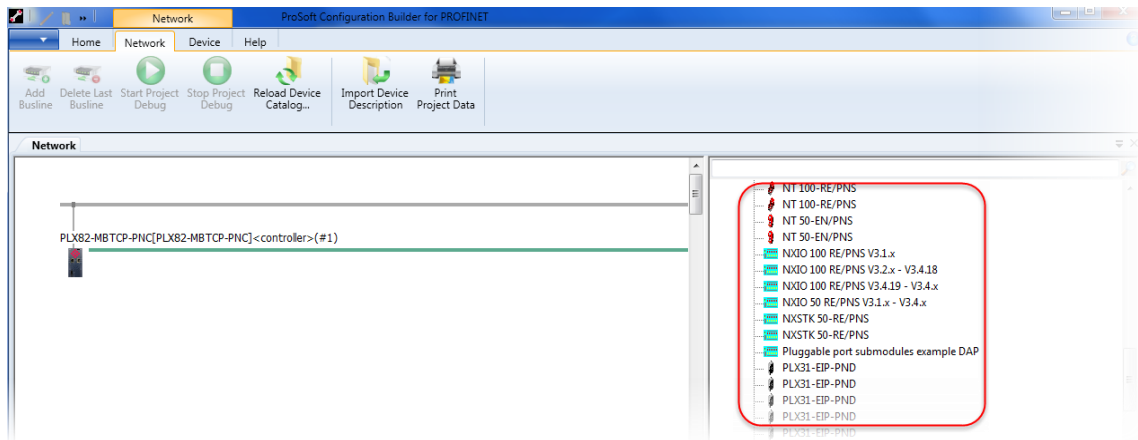

4.3 Adding Slave Devices to the Project

- 1 Locate the slave from the Slave Catalog.

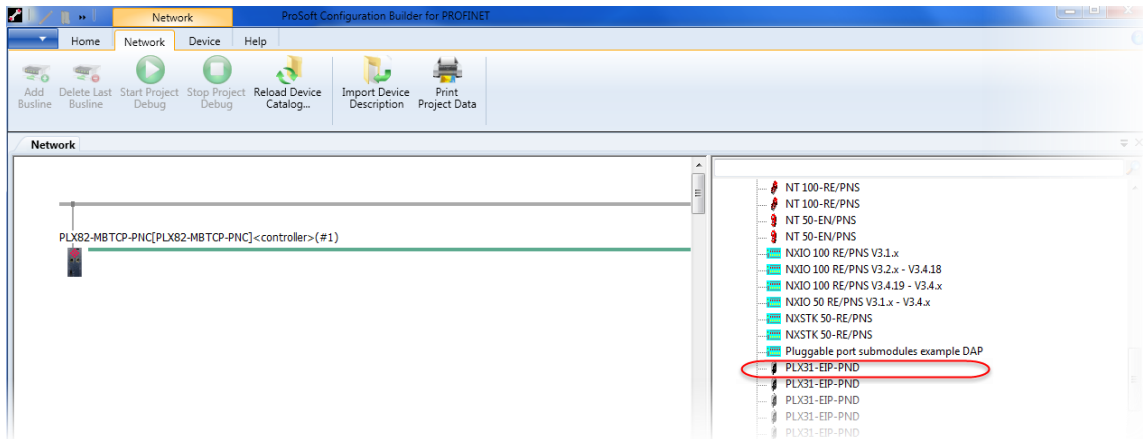

- 2 Drag and drop the slave onto the PROFINET bus line.

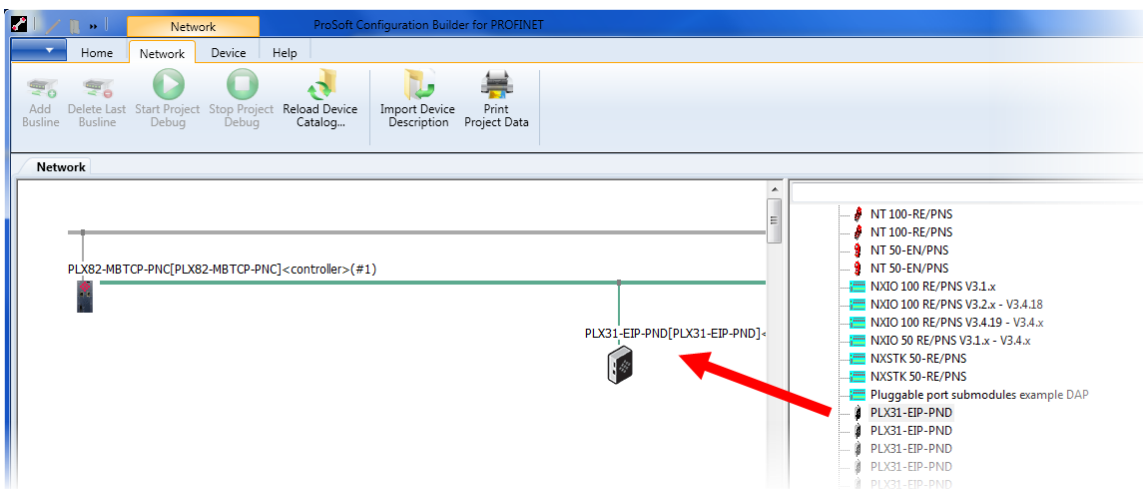

- 3 If you are installing multiple slave devices, repeat the steps above to add them to the network.

4.4 Configuring a Slave Device

This procedure configures all PROFINET slave devices for the PNC. As slaves are configured, configuration information is automatically placed in the PLX82-MBTCP-PNC. This information is visible by double-clicking on the **PLX82-MBTCP-PNC** icon.

Note: If you are adding a PND device from ProSoft Technology, ensure that this information is also mapped as part of the slave device configuration.

- 1 Double-click on the slave device icon.

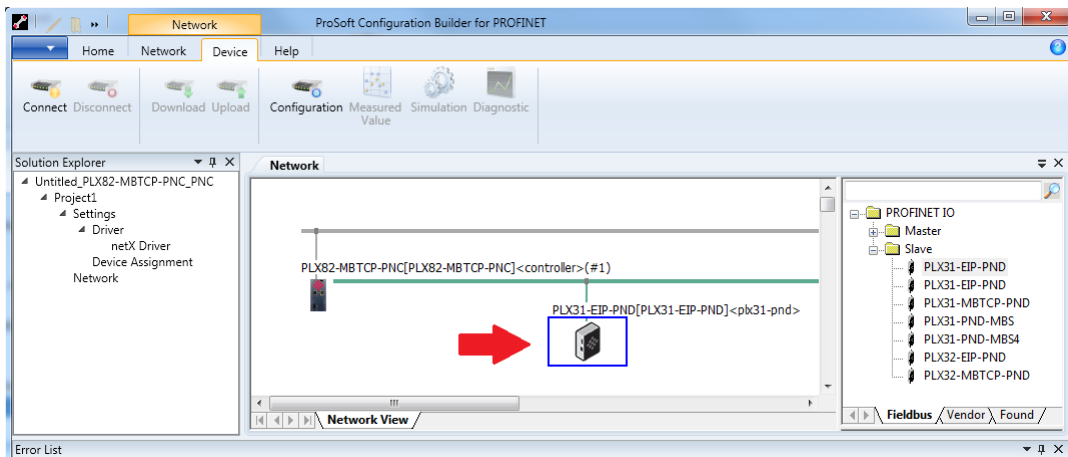

- 2 Click the **ADD MODULE** button.

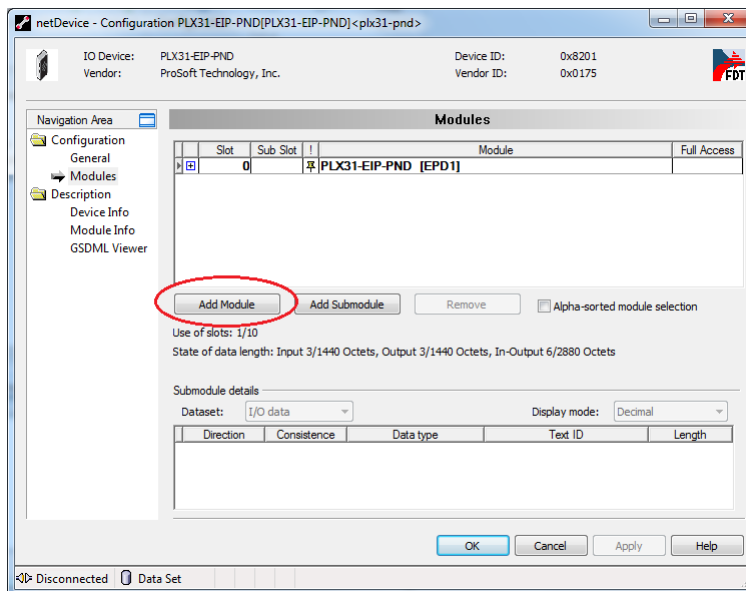

3 Select an *Input* or *Output* space allocation.

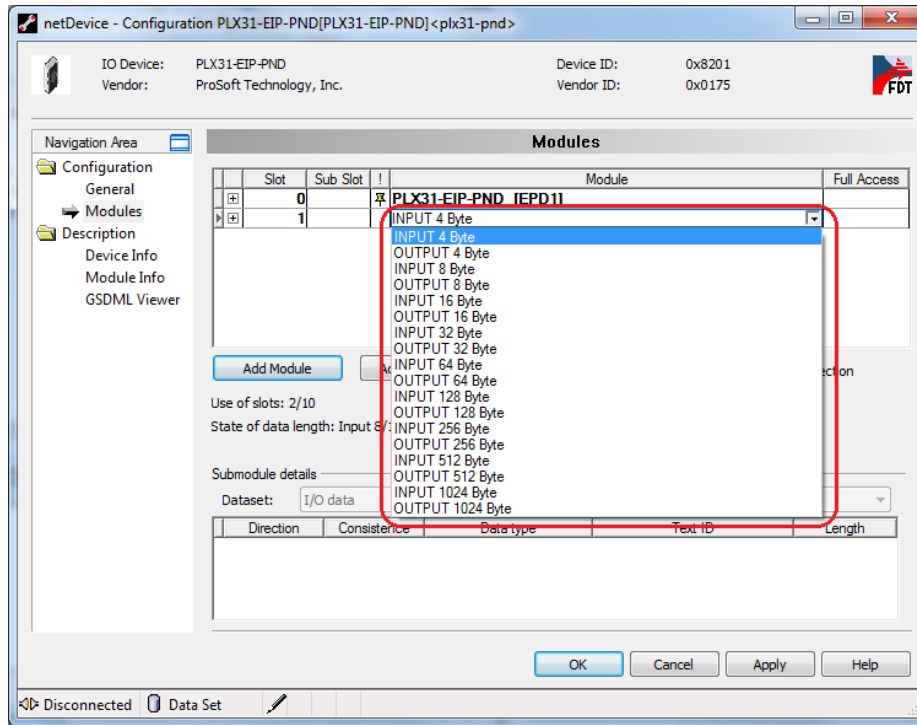

- 4** Repeat the steps 2 and 3 above for additional Inputs or Outputs.
- 5** When complete, click **APPLY** and then click **OK**.

Parameter	Description
Slot	Displays the slot number assigned to the module. Clicking on the slot field displays a drop-down list of free slot numbers. Changing the slot number changes the sequence of the modules.
Sub Slot	Displays the sub slot assigned to a sub module. Clicking on the sub slot field displays a drop-down list of free sub slot numbers.
!	Slot icon tag. This indicates the usage of the submodule. An icon in this field indicates that the Slot number, subslot number and module name are not changeable. No icon in this field indicates that the slot number, subslot number and module name are changeable.
Module	Module name as defined in the GSDML file.
ADD MODULE button	Adds a module to the device configuration below the current line.
ADD SUBMODULE button	Adds a submodule to the selected module of the device configuration below the current line.
REMOVE button	Removes the selected submodule from the configuration below the current line.

Note: Not all devices support sub-modules.

4.5 Verifying Slave Device Information

Slave devices are automatically configured. As they are configured, the new information is immediately visible in the PLX82-MBTCP-PNC configuration.

- 1 To view the configured slave device information, double-click on the **PLX82-MBTCP-PNC** icon.

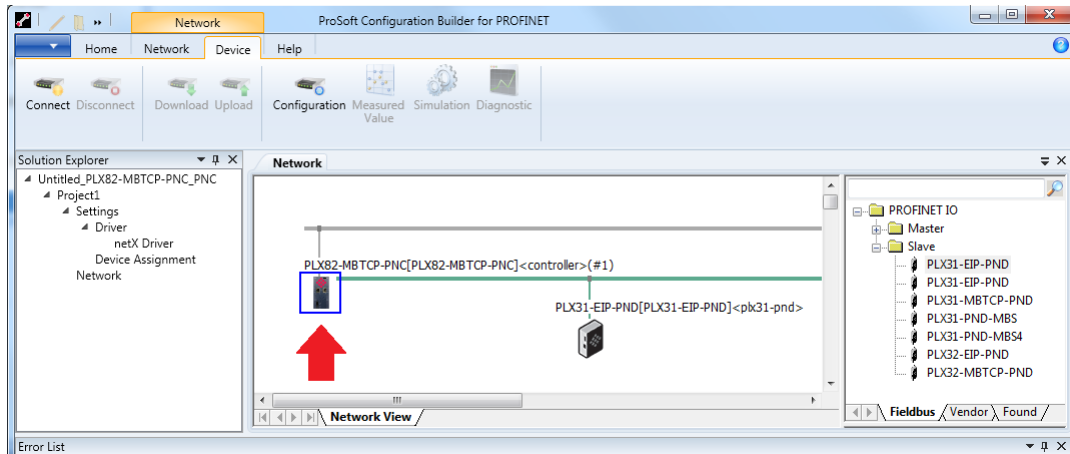

- 2 This opens the PLX82-MBTCP-PNC *netDevice Configuration* window.

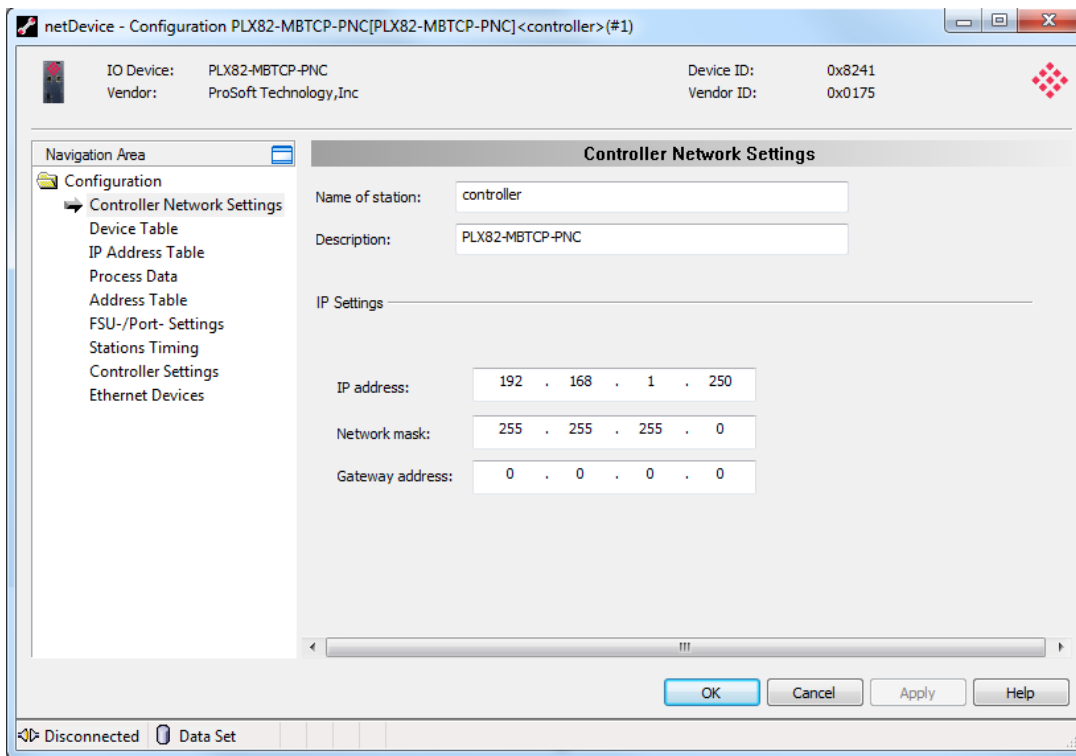

4.5.1 Controller Network Settings

The *Controller Network Settings* displays the following information:

- Name of Station
- Description of the station
- IP Address, Network Mask, and Gateway Address

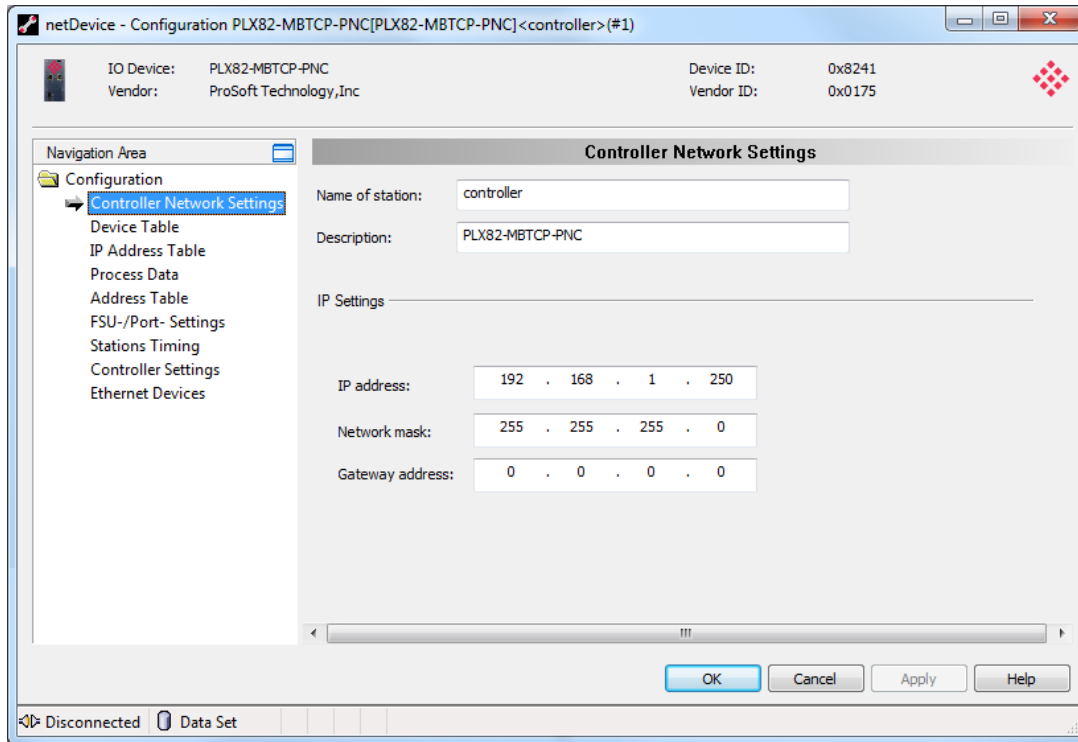

Parameter	Description
Name of Station	Network name of the PROFINET controller. This must be a DNS compatible name. 1 to 240 characters.
Description	Symbolic name of the PROFINET controller DTM.
IP Settings	
IP Address	IP address of the PROFINET controller. The PNC port has a default IP address of 192.168.0.240 .
Network Mask	Network mask of the PROFINET controller.
Gateway Address	Gateway address of the PROFINET controller.

4.5.2 Device Table

The *Device Table* lists all PROFINET slave devices connected and configured in the PROFINET controller.

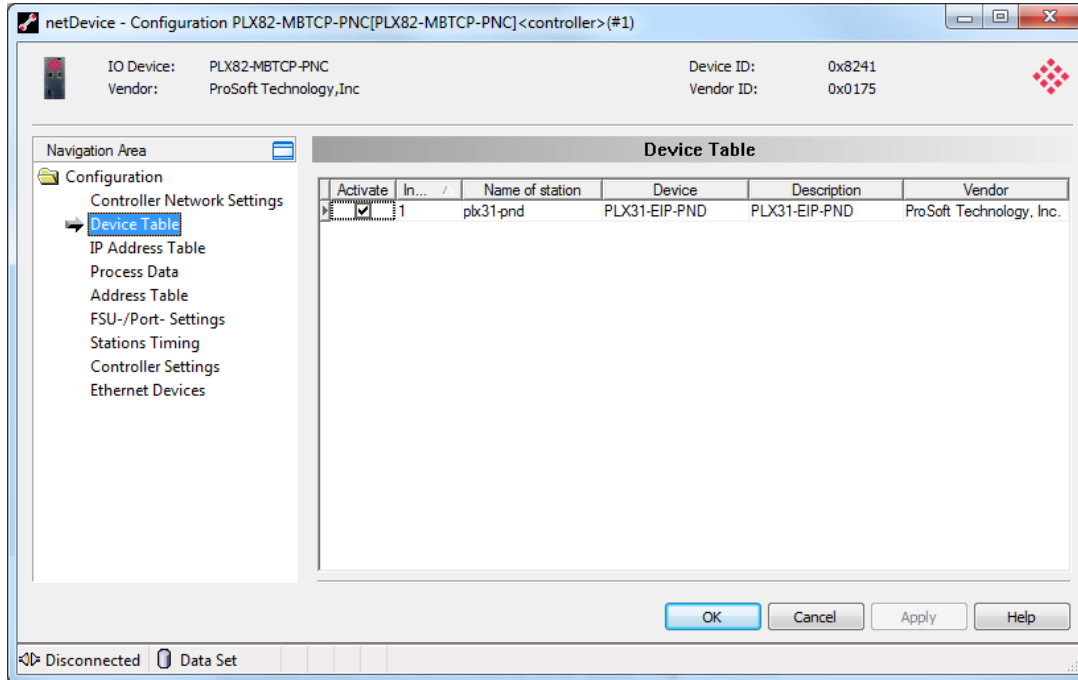

Parameter	Description
Activate	Use this checkbox to activate or deactivate a station
Index	This is editable. This allows you to set a user-defined sequence for the configured devices.
Name of Station	Name of the device.
Device	Actual device name of the slave as specified in the GSD or GSDML file.
Description	Description of the device.
Vendor	Name of the vendor of the device.

You can activate and deactivate configured devices from this table. Click the checkbox to clear the checkmark to disable, or click the checkbox to place a checkmark to enable the device.

Changing the Index number of the station:

- 1 Click on the Index number to be changed.
- 2 Edit the Index number.
- 3 When complete, click **OK**.

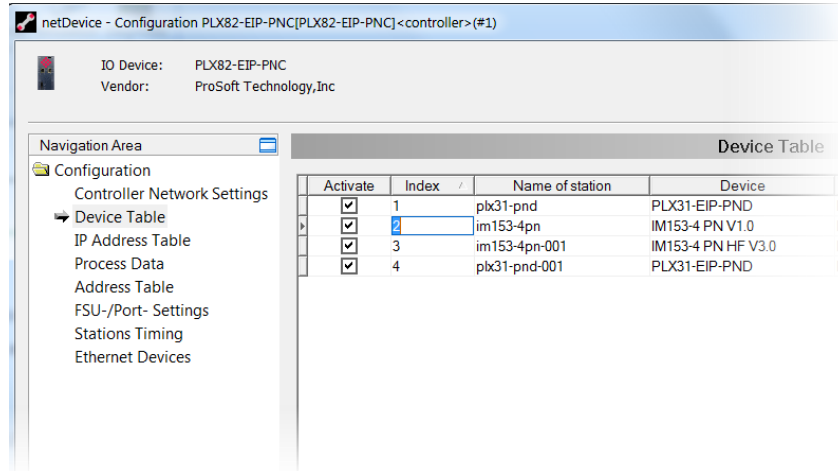

Changing the name of the station:

- 1 Click on the *Name of Station* to be changed.
- 2 Edit the *Name of Station*.
- 3 When complete, click **OK**.

4.5.3 IP Address Table

The *IP Address Table* shows the IP address of each connected slave device. The IP address is assigned automatically based on incrementing the last octet based on the IP address of the PLX82-MBTCP-PNC. For example, if the controller IP address is 192.168.0.240, the first device added will have an IP address of 192.168.0.241.

Use this pane to view or change IP addresses. Changes to the *Network Mask* or *Gateway* address are not possible with the **INHERIT** checkbox checked. 'Checked' indicates that the *Network Mask* and *Gateway* address are taken from the controller.

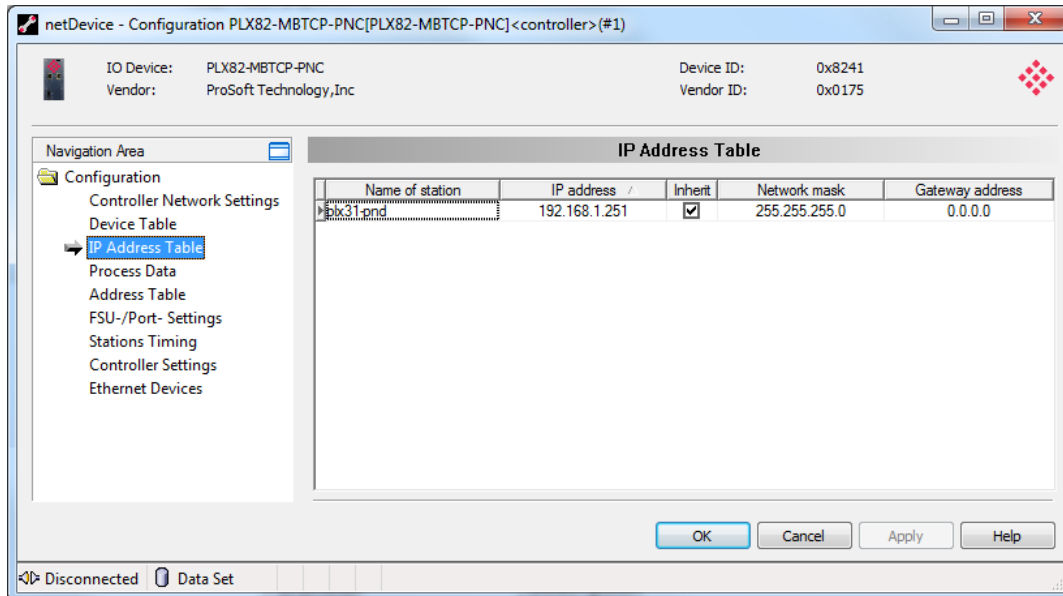

Parameter	Description
Name of station	Name of the slave device.
IP Address	IP address of the slave device. The PNC transmits the IP address of the slaves during startup.
Inherit	Indicates whether the Network Mask and the Gateway Address are taken from the controller.
Network Mask (editable)	Network mask of the slave device. The PNC transmits the network mask of the slave during startup to the slave, thereby configuring the device.
Gateway address (editable)	Gateway address of the slave device. The PNC transmits the gateway address to the slave over the network, thereby configuring the device.

Changing the IP address:

- 1 Click on the IP address in the *IP address* column and enter the new address. The *Network Mask* and *Gateway* address columns are only editable with the **INHERIT** checkbox unchecked.
- 2 Click **APPLY**, then **OK**.

4.5.4 Process Data

The *Process Data* table serves as an external process data interface (for data transfer to a PLC unit). It lists the devices connected to the controller, and well as configured modules or input or output signals of the devices. This makes the fieldbus structure visible.

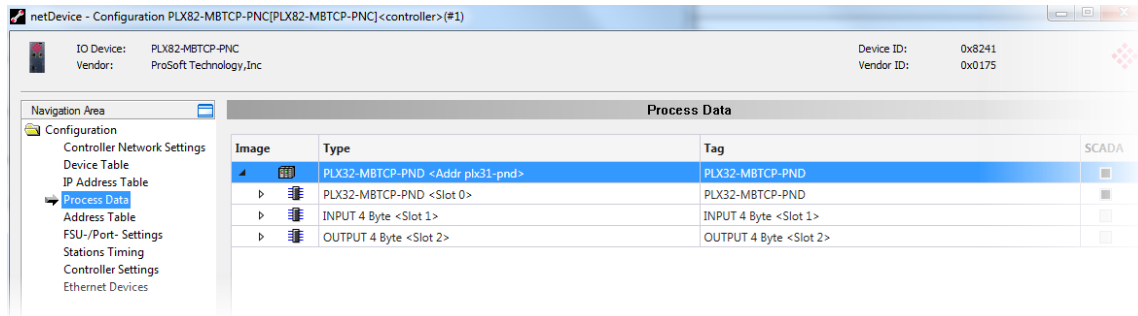

Parameter	Description
Type	Device label provided by the hardware. Provides descriptions of the modules or input or output signals configured for the device.
Tag	Device name provided by the hardware (not changeable) or the symbolic name for the modules configured for the device or input/output signals (changeable).
SCADA	Indicates which module or single data is provided for the OPC server.

4.5.5 Address Table

The *Address Table* displays a list of all addresses used in the process data image. The displayed addresses refer to the PROFINET Controller (PNC). This page allows you to view current input and output data sizes per slave device.

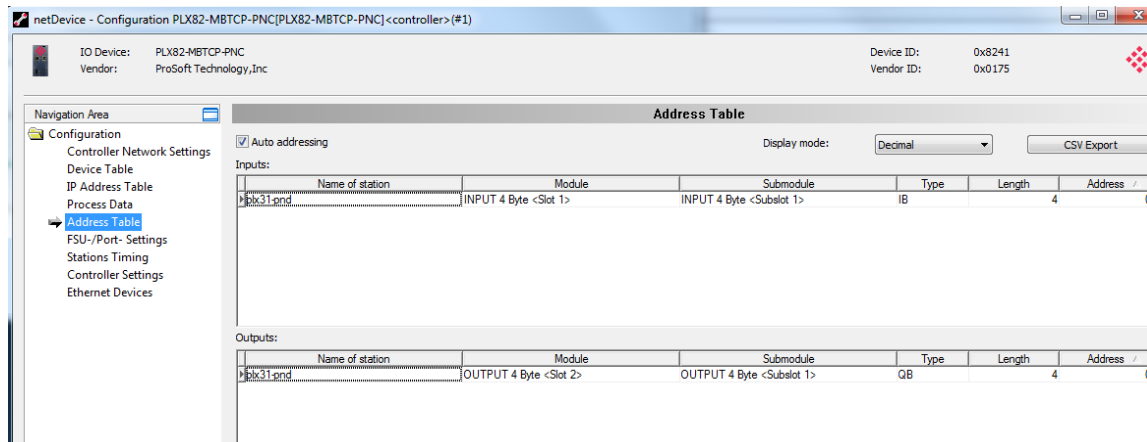

Parameter	Description
Auto addressing	Selected by default. If you want to set addresses manually, this checkbox must be unchecked (see Manual address updates).
Display mode	Allows you to display the address data in decimal or hexadecimal format.

CSV Export

This option allows you to export input and output addresses as a .CSV file (comma separated values).

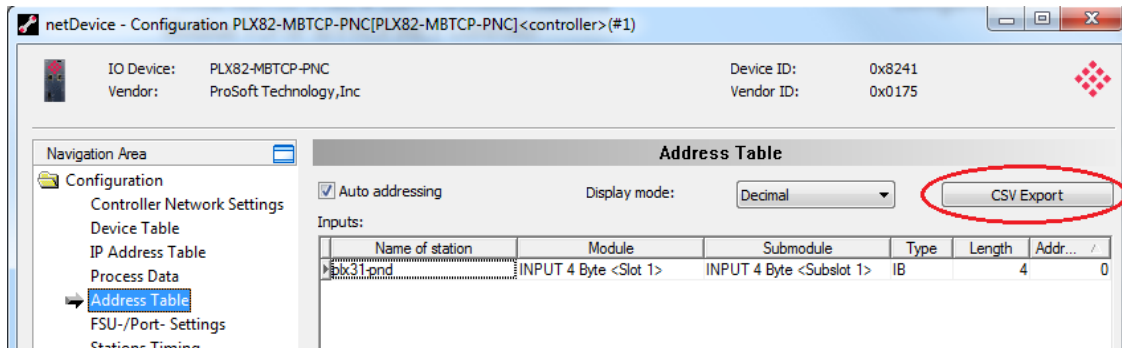

- 1 Click the **CSV EXPORT** button. The *File Save* dialog opens.
- 2 Navigate to a folder location, enter a filename, and then click **SAVE**.

The data file can be opened using a spreadsheet application or input into another application.

Manual Address Update

If manual addressing is allowed, input and output addresses of the PLX82-MBTCP-PNC may be assigned manually.

- 1 Uncheck the **AUTO ADDRESSING** checkbox.
- 2 Click on the address of a module.
- 3 Edit the field and type in a new address.
- 4 Click **OK**.

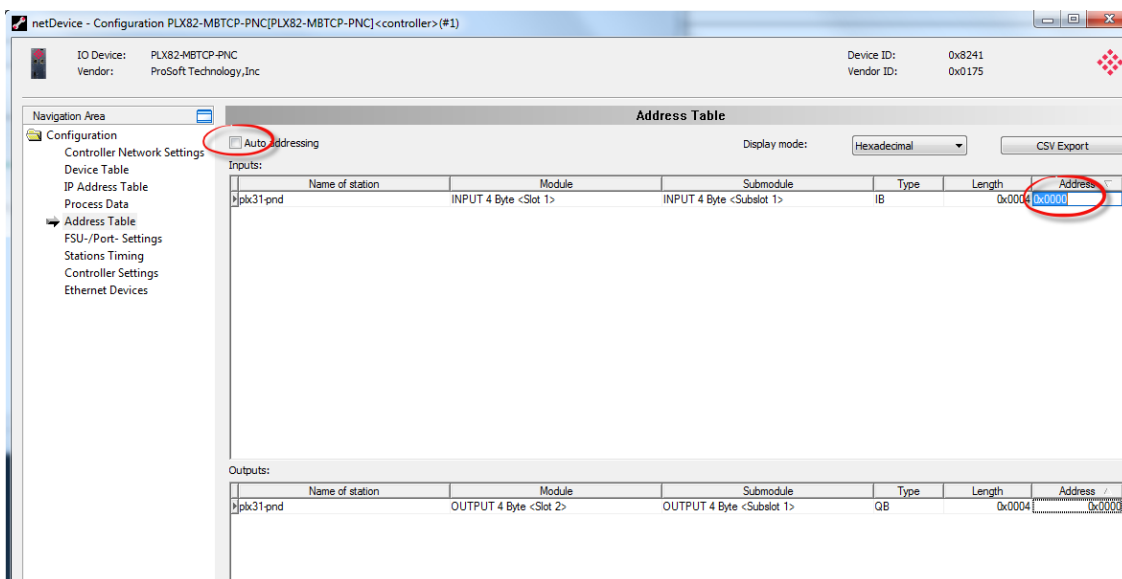

Column	Description
Name of Station	Symbolic name of the assigned slave device.
Module	Name of the module according to the GSD or GSDML file.
Submodule	Displays submodule information.
Type	Specifies the input data type or output data type (IB, QB, IW, or QW)
Length	Data length in bytes
Address	Output or input data offset addresses.

The configuration software reports an error if an address overlapping in the process data image was detected. If this occurs, correct the address for one of the two modules and enter an unused address.

4.5.6 FSU-/Port-Settings

The *Fast Start Up (FSU) Port Settings* pane is used to specify devices that must use a fast start up connection to establish the cyclic data exchange. Check with your device manufacturer to determine if your device must use FSU.

All existing connections from the controller to the devices are displayed, including all ports at each device.

The MAU Type indicates whether the device should establish the connection automatically or whether fixed parameters are to be used.

Note: If you enable FSU to establish a fast connection for a port, use only the MAU type "100BASETXFD". If using the AUTO setting, the Auto negotiation and Auto crossover effects will prevent establishing a fast Ethernet connection.

- 1 Select **CONFIGURATION > FSU-/PORT-SETTINGS** in the navigation area.

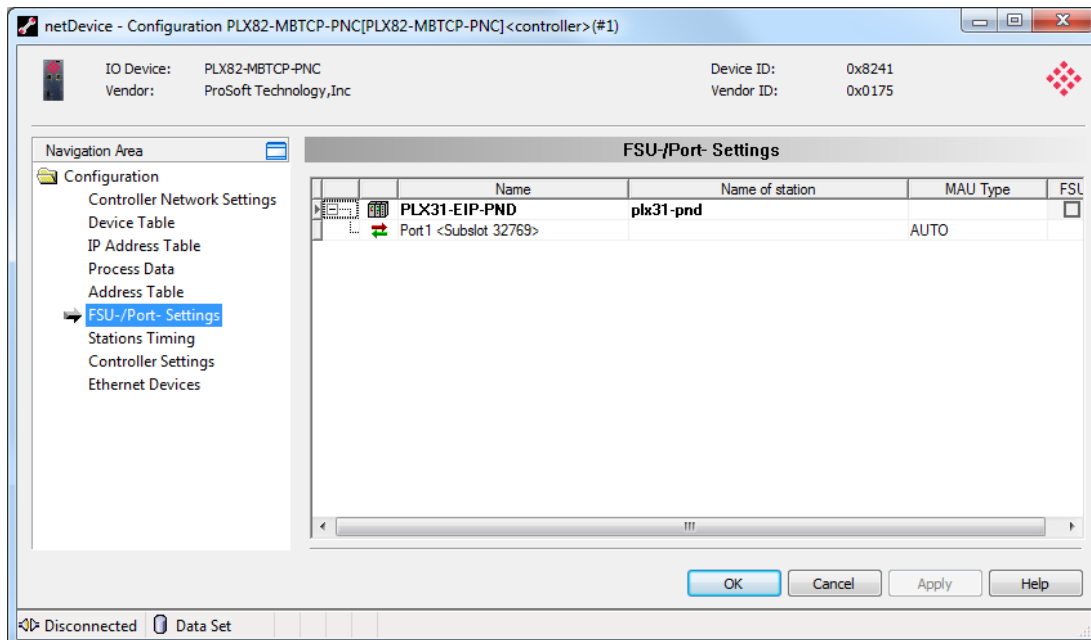

2 Check the **FSU** box for PROFINET devices that must use a fast startup (FSU) connection to establish cyclic data exchange.

Parameter	Description
Name	The symbolic name of the slave device.
Name of Station	This is the network name of the slave device. The name of the slave device is set in the Device table. The PNC uses this name to identify the slave device and to establish communication. The name of the station here must match the name of the station set in the PROFINET I/O device.
MAU Type	The MAU type defines the physical settings (PHY) on the slave device. The MAU must be set separately for each port on the device. AUTO - Connections between devices are negotiated automatically. It may take 2-3 seconds or the physical connection to be established. 100BASETXFD - Connections between devices is fixed with 100 MBit/Full duplex. IMPORTANT FOR HARDWARE WIRING Make wiring only between ports with the same port setting (MAU type configuration). Otherwise, a connection cannot be established between the devices. Connect to ports that have different cross-over settings.
FSU	Checking this box indicates that the device is configured for Fast Start Up connections in order to establish cyclic data exchange.

4.5.7 Stations Timing

The *Stations Timing* pane allows you to edit station timings.

- 1 Navigate to **CONFIGURATION > STATIONS TIMING**.
- 2 *Name of Station* - This list contains all devices associated with the PNC. Select the station from the list.

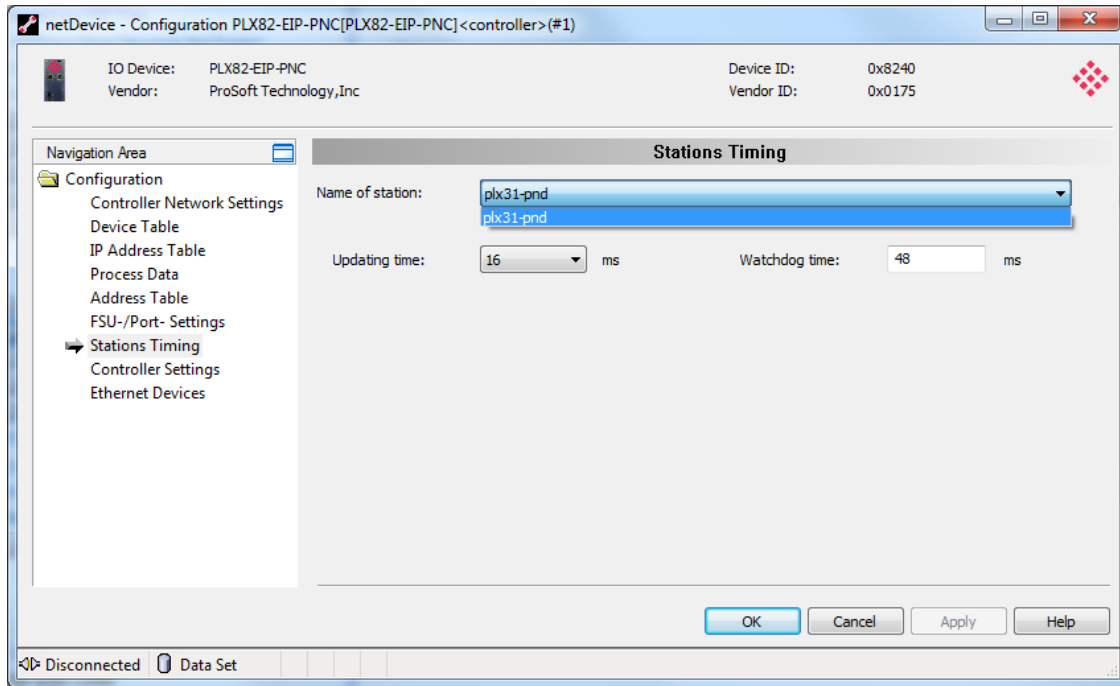

- 3 Set the *Update time* in milliseconds.
- 4 Set the *Watchdog time* in milliseconds.
- 5 Click **APPLY** to save your settings.
- 6 When complete, click **OK**.

4.5.8 Controller Settings

The *Controller Settings* pane allows you to control the behavior of the PNC controller.

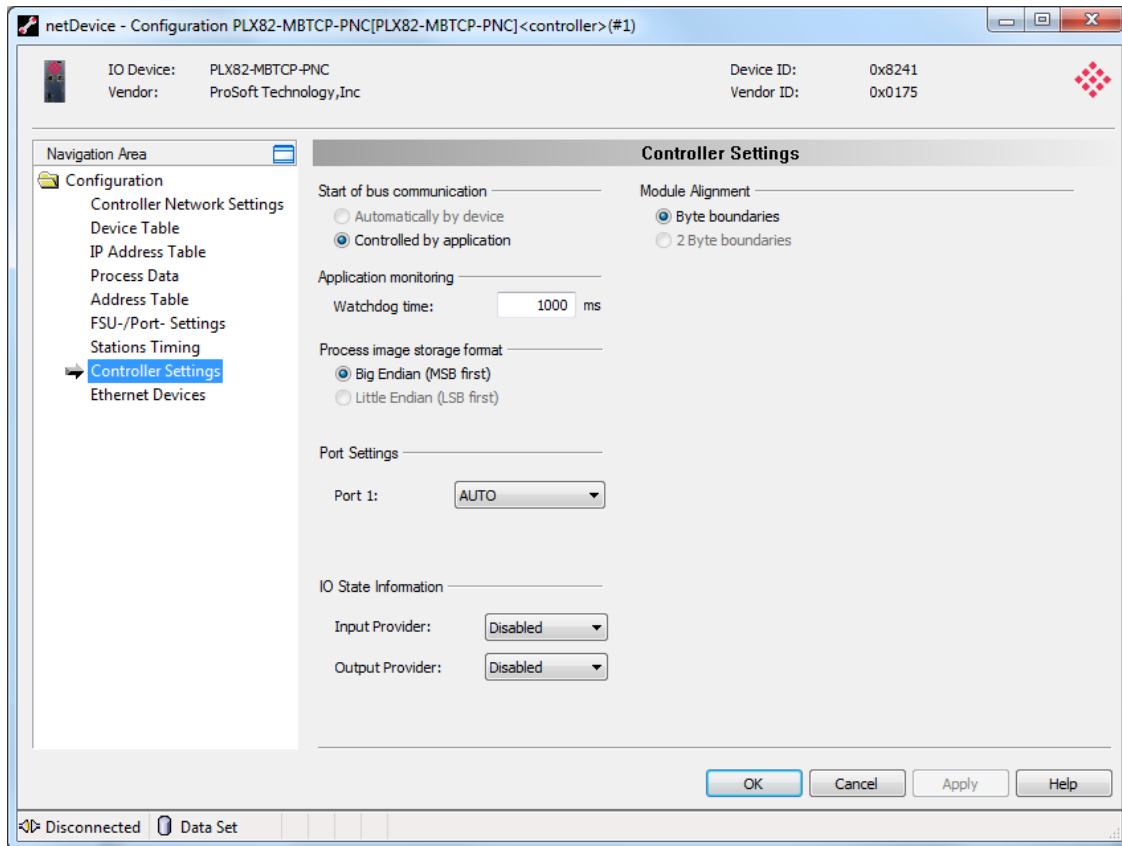

Parameter	Description								
Start of bus communication	<p>Automatically by device or Controlled by application.</p> <p>If automatically by device, the PNC controller starts with the data exchange on the bus after initialization has ended.</p> <p>If controlled by application, the application program must activate data exchange on the bus.</p> <p>The default is typically set to Controlled by application.</p>								
Application monitoring	<p>Watchdog time is set per station in the Stations Timing window. This field displays the watchdog time in milliseconds. The Watchdog time determines the time in which the device watchdog must be re-triggered from the application program while application monitoring is activated.</p> <p>When the watchdog time value is equal to 0, the watchdog is deactivated and application program monitoring is deactivated.</p> <table border="1"> <thead> <tr> <th>Watchdog time</th> <th>Range of Value/Default Value</th> </tr> </thead> <tbody> <tr> <td>Permissible range of values</td> <td>20 - 65535 ms</td> </tr> <tr> <td>Default</td> <td>1000 ms</td> </tr> <tr> <td>Deactivated</td> <td>0 ms</td> </tr> </tbody> </table>	Watchdog time	Range of Value/Default Value	Permissible range of values	20 - 65535 ms	Default	1000 ms	Deactivated	0 ms
Watchdog time	Range of Value/Default Value								
Permissible range of values	20 - 65535 ms								
Default	1000 ms								
Deactivated	0 ms								
Process image storage format	<p>Big Endian (Most Significant Byte first)</p> <p>Little Endian (Least Significant Byte first)</p>								

Parameter	Description
Port Settings	<p>Displays or selects Port 1 and Port 2 settings. This is used if Fast Start Up (FSU) is selected for PROFINET devices that use a FSU connection to establish a cyclic data exchange.</p> <p>If FSU is checked on a port, you must select 100BASETXFD. Otherwise, select AUTO.</p>
IO State Information	<p>Input Provider - Disabled, Bit, Byte Output Provider - Disabled, Bit, Byte</p> <p>Allows you to configure the PROFINET Input/Output Object Provider State (IOPS). This allows the PNC to detect whether data received from a slave is valid or not.</p> <p>Disabled - The PROFINET Controller application cannot detect whether the data received from the slaves are valid or declare its out data sent to the slaves are valid or invalid.</p> <p>Bit - IOPS is handled as a bit list. Each sub-module description is represented by a single bit. If set to 1, the data is valid. If set to 0, the data is invalid. Sub-modules with input and output data simultaneously have IOPS in input and output directions.</p> <p>Byte - In the dual-port memory (DPM) of the PNC, IOPS is handled as a byte array. Each sub-module description is represented as a byte. If the byte is set to 0x80, the data is valid. Otherwise, the data is considered invalid.</p> <p>In this mode, the entire IOPS byte is directly copied from/to the cyclic frame, providing the PNC's application program the possibility of accessing all bits of IOPS. Typically, only the first bit of the IOPS byte states whether the data is valid or invalid.</p>
Module Alignment	<p>Byte boundaries 2 byte boundaries</p> <p>Module alignment defines the addressing mode of the process data image. The addresses (offsets) of the process data are always interpreted as byte addresses. The Module Alignment then defines the addressing mode.</p>

4.5.9 Ethernet Devices

The *Ethernet Devices* pane provides a view of all slave devices on the network after performing a search. It also allows you to edit each device. The device name must match the *Name of Station* field.

- 1 Select the **ETHERNET DEVICES** icon.

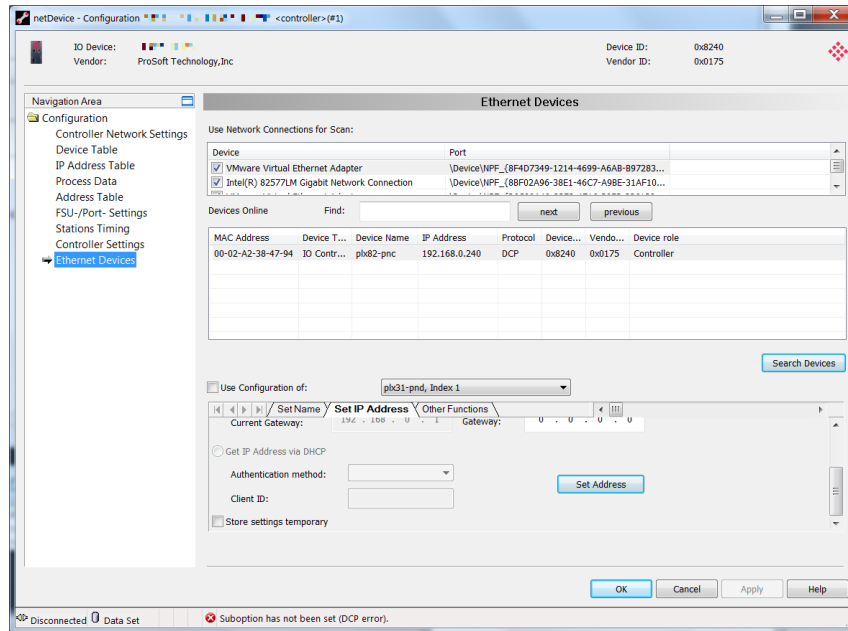

- 2 Click the **SEARCH DEVICES** button to start the search.

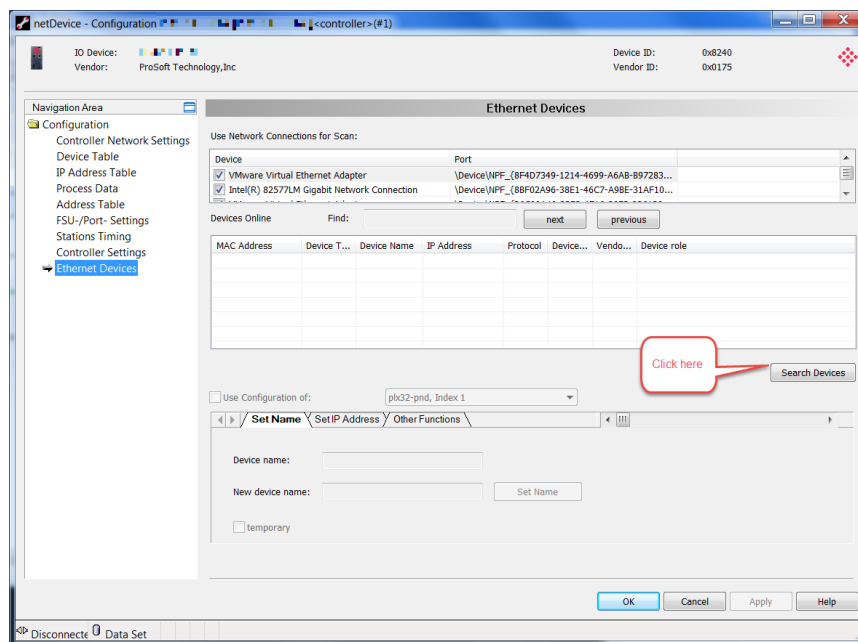

3 The current online devices appear in the grid.

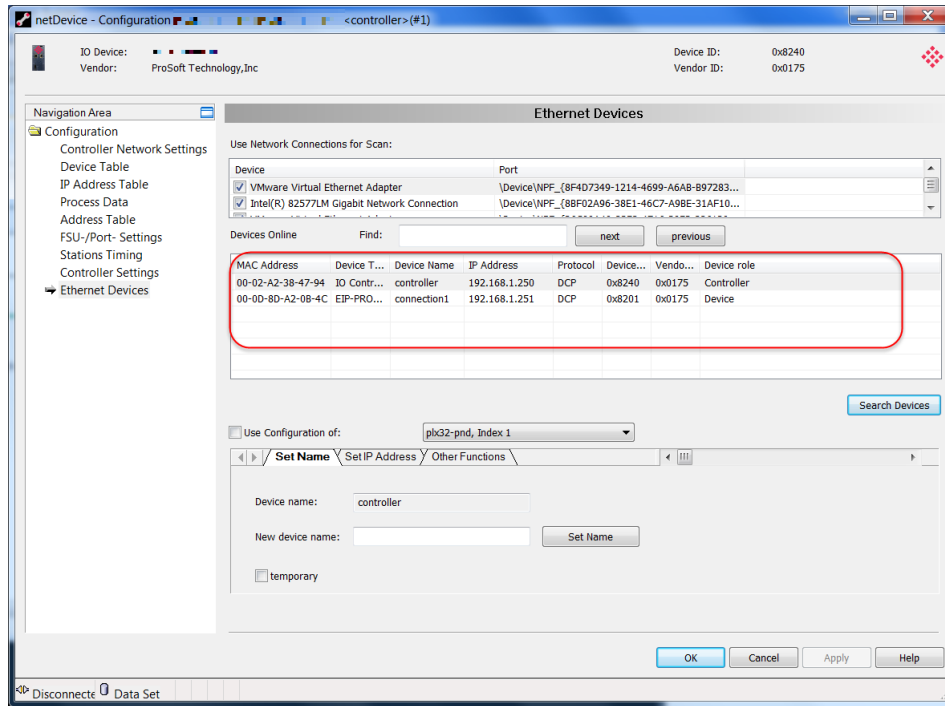

Parameter	Description
MAC Address	Unique address of the device set by the device manufacturer.
Device Type	Name given to the device that provides a description of the device.
Device Name	Name of the device as a character string defined by the manufacturer.
IP Address	IP address of the device that can be set in the IP Address Table pane. The IP address must be unique and must fit into the current network. The IP address of 0.0.0.0 indicates that no IP address has been set.
Protocol	Supported protocol of the device.
Device ID	Identification number of the device. This is fixed by the manufacturer.
Vendor ID	Identification number of the device vendor assigned by PROFIBUS.
Device Role	Description of the function that the device has on the network. For example, device, controller, multi-device, etc.

Creating New, or Using Existing Configuration Information

The lower area of the *Ethernet Devices* pane allows you to change information returned by the search.

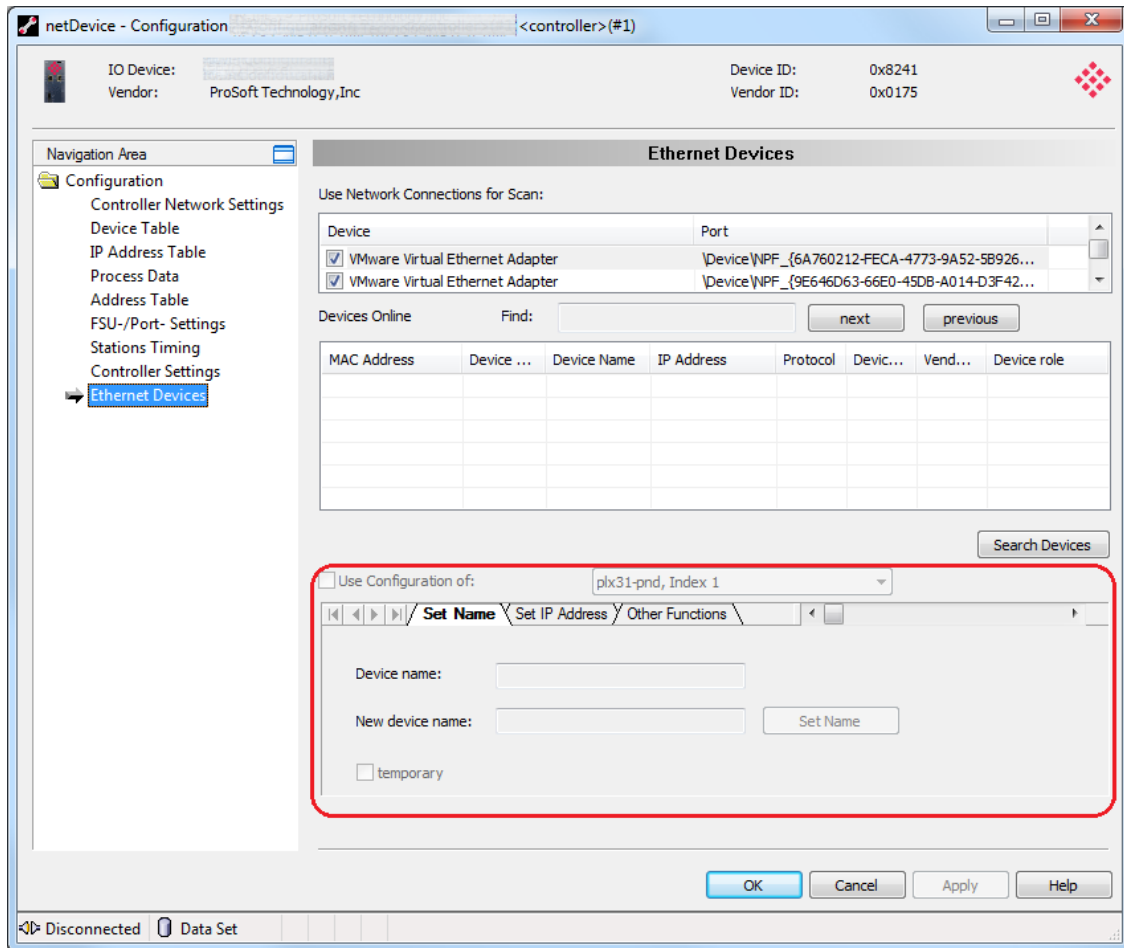

Note: If you are going to use a configuration from a different device, use the "Use Configuration of" section.

The current system allows you to change/set the device name and IP address. Highlight the device that you want to modify and click on the *Set Name*, *Set IP Address*, or *Other Functions* tabs to enter new information.

***Set Name (new configurations)**

Enter the new device name and click the **SET NAME** button. If you are changing the name of the PROFINET controller, the name must match the name specified in the *Controller Network Settings* page.

For example, if the *Device name* in the *Controller Network Settings* pane is '**controller**'...

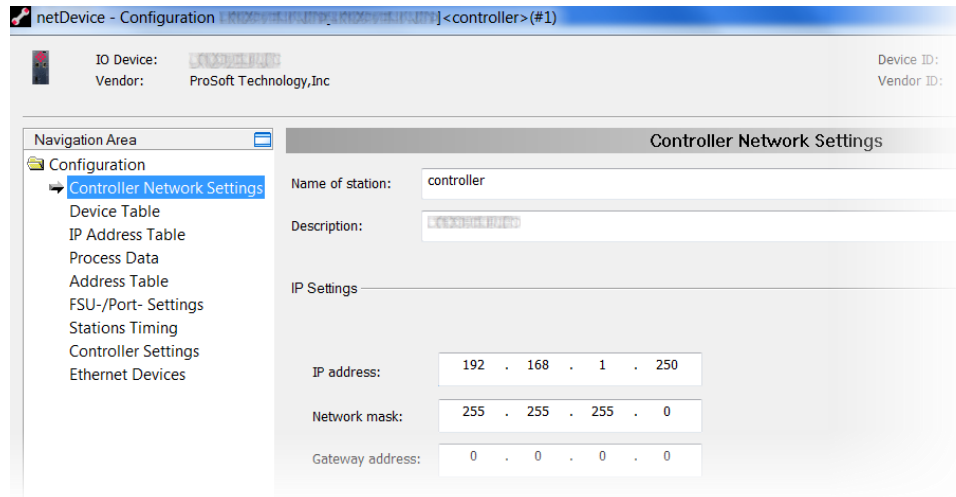

Enter a name in the *New Device Name* parameter and click the **SET NAME** button:

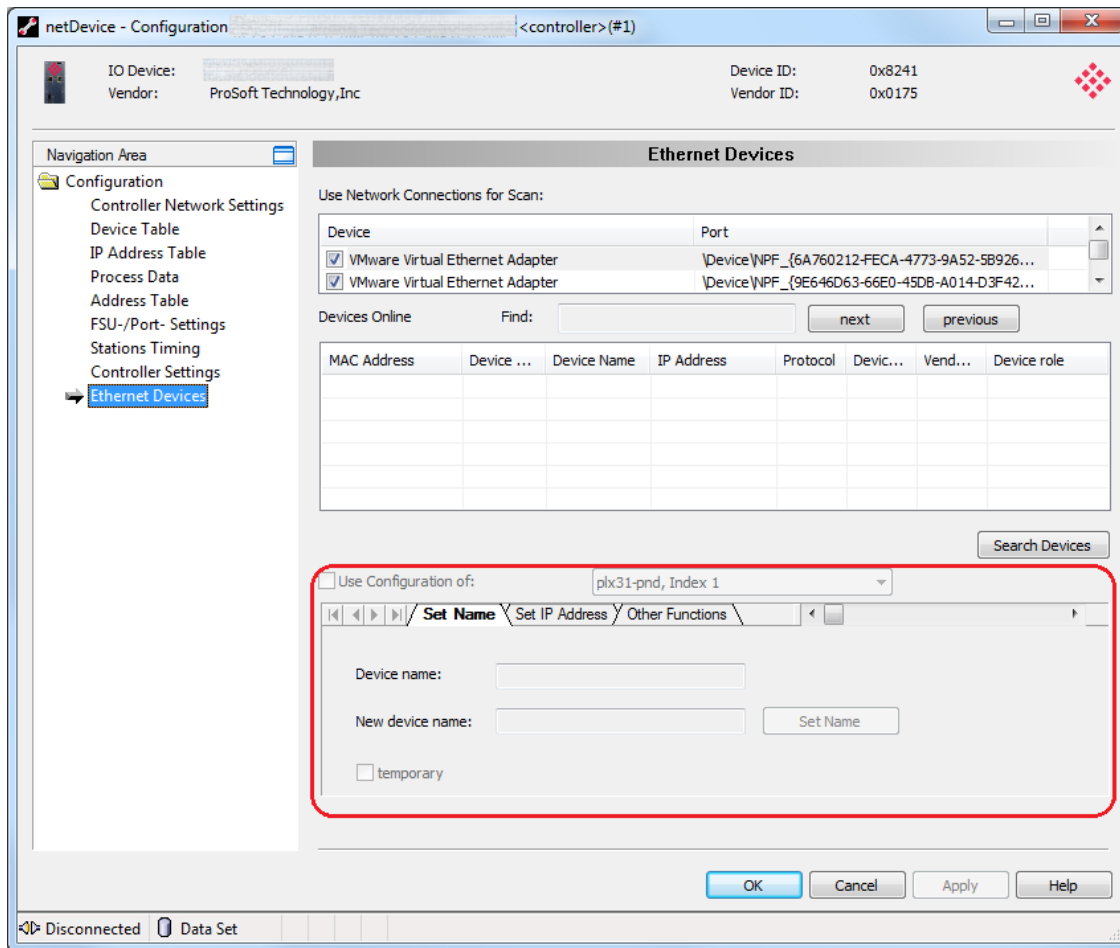

***Set IP Address (new configurations)**

Enter the IP address, Subnet mask, and Gateway address of this device and then click the **SET ADDRESS** button.

You can also obtain an IP address via DHCP by checking the *Get IP Address via DHCP* radio button.

***Other Functions** - Signal or Reset the module to factory defaults.

- The **Signal** button causes the LED on the selected device to blink. This allows you to easily identify a specific device among other devices.
- The **Reset** to factory defaults button sets the device to back to factory defaults.

When complete, click **APPLY**, then **OK** to save changes.

Use Configuration of...

You can define whether the configuration for a device is created from scratch or use an existing configuration.

Creating a new configuration:

- 1 Uncheck the **USE CONFIGURATION OF** checkbox to create a new configuration, or check **USE CONFIGURATION OF** box if an existing configuration will be used.
- 2 Select the device whose configuration will be used for the selected device.

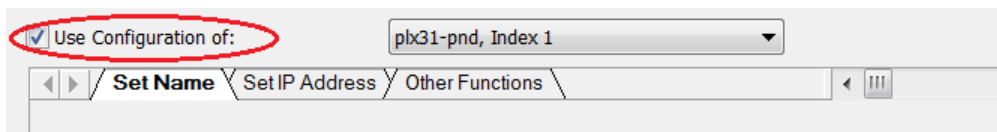

Setting a New Device Name

- 1 Uncheck the **USE CONFIGURATION OF** box.
- 2 Click the **SET NAME** tab.

For PROFINET I/O devices (controller or device)...

- 1 The current name is displayed in the *Device name* field.
- 2 Enter a new device name in the *New device name* field.

- If you are setting this device name as a temporary device name, check the temporary checkbox.

- If you are setting this device name as a permanent change, make sure that the temporary checkbox is unchecked.

- 3 Click the **SET NAME** button. The new device name is now used as the current device name.

4.5.10 Viewing Configured Device Information

Device Info

The *Device Info* pane displays manufacturer information about the device, which is defined in the GSDML file.

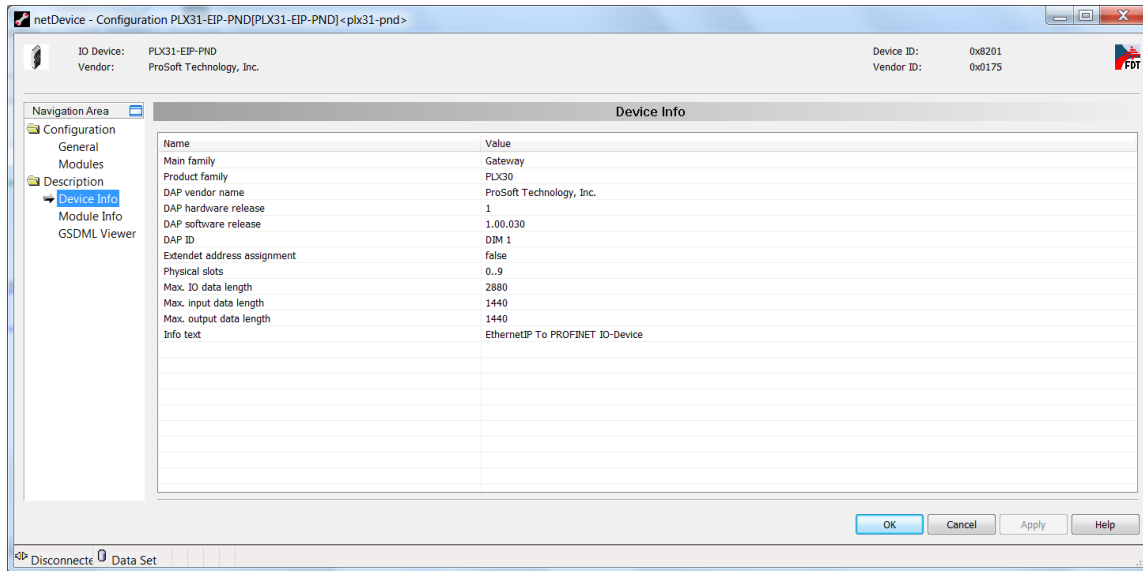

Parameter	Value
Main family	Attribute of the GSDML family element. It contains the assignment of the device to a function class. One of the following values are allowed: <ul style="list-style-type: none"> ▪ General Drives ▪ Switching Devices ▪ I/O ▪ Valves ▪ Controllers ▪ HMI ▪ Encoders ▪ NC/RC ▪ Gateway ▪ Programmable Logic Controllers ▪ Ident systems ▪ PROFIBUS PA Profile ▪ Network Components Sensor
Product family	Attribute of the GSDML family element. It contains the vendor-specific assignment of the device to a product family. In addition to the main family, a device can be assigned to a vendor-specific product family.
DAP vendor name	Attribute of the GSDML ModuleInfo/VendorName element. The VendorName element contains the name of the device vendor. The device access point (DAP) is a module of the GSDML to describe the device parameters specific device. The device access point object contains most of the device-related keywords.

Parameter	Value
DAP hardware release	Attribute of the GSDML ModuleInfo/HardwareRelease element. The HardwareRelease element contains the hardware release of the DAP.
DAP software release	Attribute of the GSDML ModuleInfo/SoftwareRelease element. The SoftwareRelease element contains the software release of the DAP.
Extended Address Assignment	Attribute of the GSDML DeviceAccessPointItem element. It depends on the protocol for the assignment of the IP addresses supported by the DAP. Default: "false" for the Discovery and Configuration (DCP), "true" for the Dynamic Host Configuration Protocol (DHCP).
Physical slots	Attribute of the GSDML DeviceAccessPointItem element. This list describes which slots are supported by the DAP. The slot number of the DAP itself shall be part of the list.
Max. I/O data length	Attribute of the GSDML DeviceAccessPointItem IOConfigData element. It contains the maximum length of the output and input data in octets. MaxDataLength shall not be less than the highest value of MaxInputLength or MaxOutputLength. It shall not be greater than the sum of MaxInputLength and MaxOutputLength. If the keyword is not provided, the maximum length is the sum of MaxInputLength and MaxOutputLength.
Max input data length	Attribute of the GSDML DeviceAccessPointItem IOConfigData element. It contains the maximum length of the data in octets which can be transferred from the I/O device to the I/O controller. This length is defined by the sum of the output data of all used submodules, the corresponding I/O producer status, and the I/O consumer status of the used input submodules.
Max output data length	Attribute of the GSDML DeviceAccessPointItem IOConfigData element. It contains the maximum length of the data in octets which can be transferred from the I/O controller to the I/O device. This length is defined by the sum of the output data of all used submodules, the corresponding I/O producer status, and the I/O consumer status of the used input submodules.
Info text	GSDML ModuleInfo/InfoText element. This element contains human readable additional text information about the device.

Module Info

The **SELECT MODULE** drop-down list of the *Module Info* pane displays all available modules described in the GSDML file.

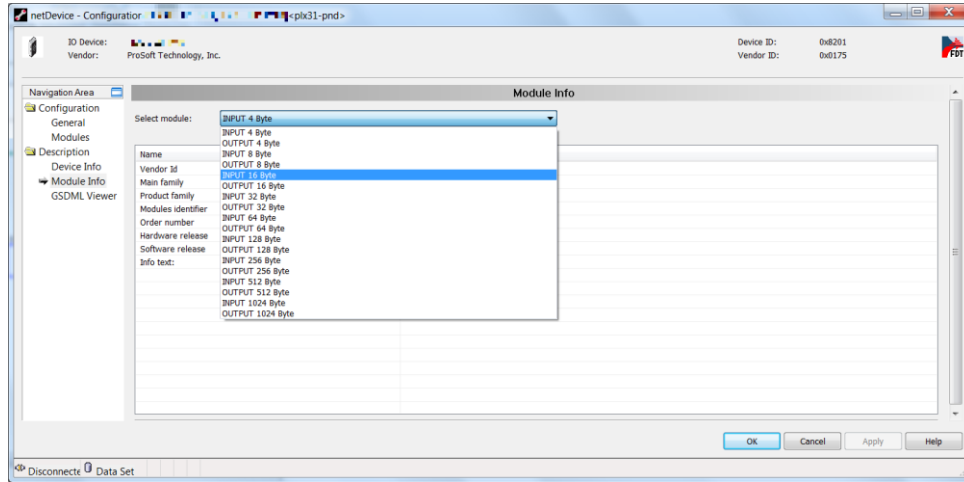

Name	Value
Vendor ID	Vendor Identification Number
Main family	Attribute of the GSDML family element. It contains the assignment of the device to a function class. One of the following values are allowed: <ul style="list-style-type: none"> ▪ General Drives ▪ Switching Devices ▪ I/O ▪ Valves ▪ Controllers ▪ HMI ▪ Encoders ▪ NC/RC ▪ Gateway ▪ Programmable Logic Controllers ▪ Ident Systems, ▪ PROFIBUS PA Profile ▪ Network Components ▪ Sensors
Product family	Attribute of the GSDML family element. It contains the vendor-specific assignment to a product family. In addition to the main family, a device can be assigned to a vendor-specific product family.
Modules identifier	Identification number of the module.
Order number	GSDML ModuleInfo/OrderNumber element. Contains the module order number.
Hardware release	GSDML ModuleInfo/HardwareRelease element. Contains the module hardware release.
Software release	GSDML ModuleInfo/SoftwareRelease element. Contains the module software release.
Info text	GSDML ModuleInfo/InfoText element. This element contains human-readable information about the module.

5 PROFINET Start Input and Output Byte Offsets

The *PNC* option in PCB allows you to set the PROFINET *Start Input Byte Offset* and *Start Output Byte Offset* values within PLX82-MBTCP-PNC internal memory. You can also use this area to configure floating point or other multi-register values.

To edit these values, double-click on the **PNC > PNC** icon to display the *Edit - PNC* dialog as shown:

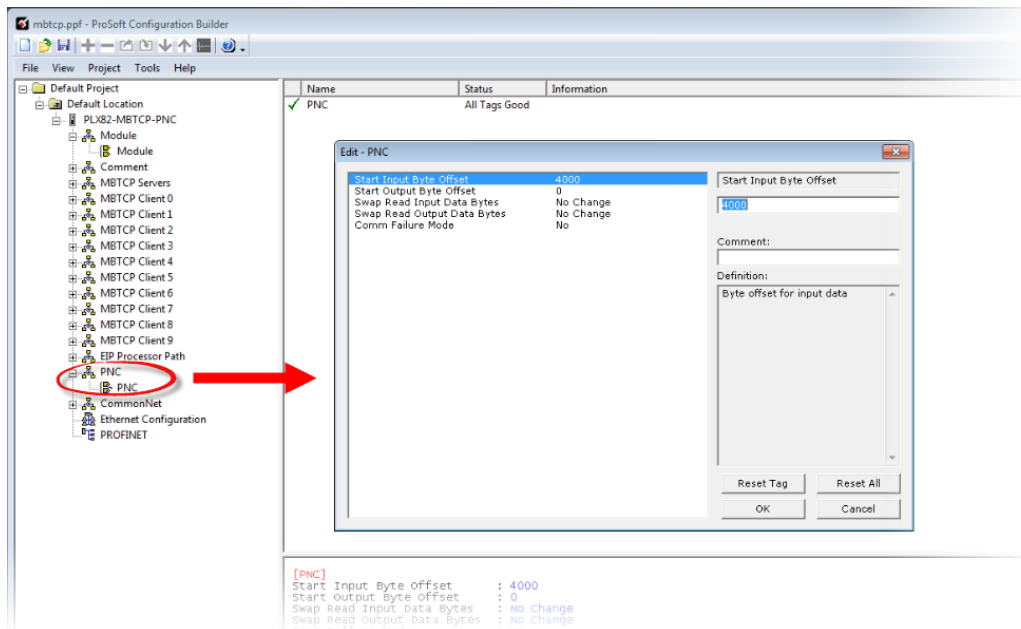

Parameter	Description								
Start Input Byte Offset	Byte offset for input data								
Start Output Byte Offset	Byte offset for output data								
Swap Read Input Data Bytes	Use this parameter when dealing with floating-point or other multi-register values, as there is no standard method of storage of these data types in devices. This parameter can be set to order the register data received in an order useful by other applications. The following table defines the values and their associated operations: <table border="0" style="margin-left: 20px;"> <tr> <td style="padding-right: 20px;">0</td> <td>None. No change is made in the byte ordering.</td> </tr> <tr> <td>1</td> <td>Words. The words are swapped.</td> </tr> <tr> <td>2</td> <td>Words and Bytes. The words are swapped, then the bytes in each word are swapped.</td> </tr> <tr> <td>3</td> <td>Bytes. The bytes in each word are swapped. The words should be swapped only when using an even number of words.</td> </tr> </table>	0	None. No change is made in the byte ordering.	1	Words. The words are swapped.	2	Words and Bytes. The words are swapped, then the bytes in each word are swapped.	3	Bytes. The bytes in each word are swapped. The words should be swapped only when using an even number of words.
0	None. No change is made in the byte ordering.								
1	Words. The words are swapped.								
2	Words and Bytes. The words are swapped, then the bytes in each word are swapped.								
3	Bytes. The bytes in each word are swapped. The words should be swapped only when using an even number of words.								

Parameter	Description								
Swap Read Output Data Bytes	<p>Use this parameter when dealing with floating-point or other multi-register values, as there is no standard method of storage of these data types in devices. This parameter can be set to order the register data received in an order useful by other applications. The following table defines the values and their associated operations:</p> <table><tbody><tr><td data-bbox="686 436 699 462">0</td><td data-bbox="881 436 1279 489">None. No change is made in the byte ordering.</td></tr><tr><td data-bbox="686 506 699 531">1</td><td data-bbox="881 506 1230 531">Words. The words are swapped.</td></tr><tr><td data-bbox="686 543 699 569">2</td><td data-bbox="881 543 1349 596">Words and Bytes. The words are swapped, then the bytes in each word are swapped.</td></tr><tr><td data-bbox="686 609 699 634">3</td><td data-bbox="881 609 1349 684">Bytes. The bytes in each word are swapped. The words should be swapped only when using an even number of words.</td></tr></tbody></table>	0	None. No change is made in the byte ordering.	1	Words. The words are swapped.	2	Words and Bytes. The words are swapped, then the bytes in each word are swapped.	3	Bytes. The bytes in each word are swapped. The words should be swapped only when using an even number of words.
0	None. No change is made in the byte ordering.								
1	Words. The words are swapped.								
2	Words and Bytes. The words are swapped, then the bytes in each word are swapped.								
3	Bytes. The bytes in each word are swapped. The words should be swapped only when using an even number of words.								

6 Acyclic Data

Acyclic messages are used for unscheduled, on demand, communications that include the exchange of PROFINET alarms, configuration and diagnostic data.

The following sections describe acyclic read/write and acyclic alarms.

6.1 Read/Write Data

Reading PROFINET device configuration and status, or writing PROFINET device configurations can be accomplished by writing a MBTCP message to the PLX82-MBTCP-PNC. Responses to the message are generated by the PLX82-MBTCP-PNC generating its own MBTCP message.

The following diagram illustrates acyclic read/write data flow through the PLX82-MBTCP-PNC.

1. Client sends request. PLX82-MBTCP-PNC responds to Modbus TCP indicating receipt of the message.
2. PLX82-MBTCP-PNC passes request to the PROFINET device.
3. PROFINET device responds to the message.
4. PLX82-MBTCP-PNC generates a Function 16 MBTCP write request message to the MBTCP server that contains the data from the PROFINET device. The server sends a response to acknowledge that it received the request.

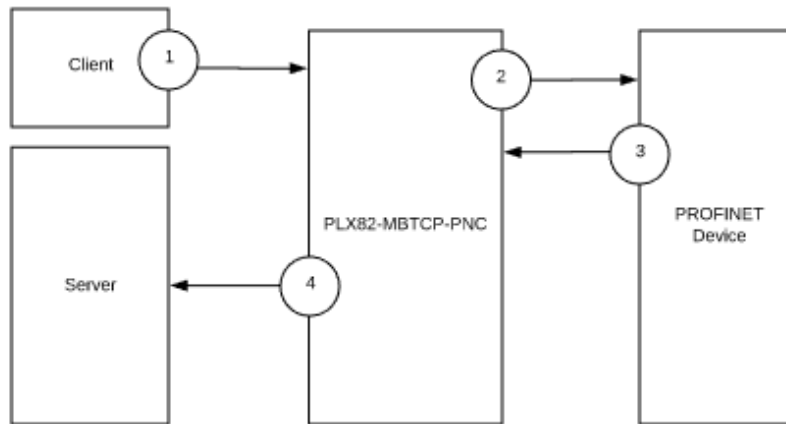

Note: The size of data in Step 4 is determined by the original request by the server.

Generating Requests

To generate an acyclic request, a function code 16 write request to address 11000 is made by an MBTCP client to the PLX82-MBTCP-PNC.

Note: Refer to the PROFINET device manufacturer's documentation for information on how to configure the Slot Number, Sub-slot Number, and Index for read or write requests. Refer to the PROFINET device manufacturer's documentation for information on how to configure the length in bytes and write data for the write requests.

Acyclic Write

An acyclic write has the following format:

Modbus Address	Register Data	Description
11000	0x65	The register indicates a read or write command
11001	Slave ID	The Slave ID of the PROFINET device to write
11002	Slot Number	The slot number of the slot to write
11003	Sub-slot Number	The sub-slot number of the slot to write.
11004	Index	The index to write
11005	Length in bytes	The number of bytes to be written
*11006 to 11006 + [(Length in bytes + 1)/2] - 1	Write data	The data to be written to the above Slave ID, slot number, sub-slot number and index.

*For example:

- 10 bytes would have an address range of 11006 to 11010 for the write data
- 11 bytes would have an address range of 11006 to 11011 for the write data

*This is calculated as 11006 to 11006 + [(length in bytes + 1)/2]-1. Truncate if necessary.

Acyclic Read

An acyclic read has the following format:

Modbus Address	Register Data	Description
11000	0x64	This register indicates a read or write command.
11001	Slave ID	The slave ID of the PROFINET device to read.
11002	Slot Number	The slot number of the slot to read.
11003	Sub-slot Number	The sub-slot number of the slot to read.
11004	Index	The index to read.

Read Example (looking at a device's expected slot configuration [with slave ID = 5]):

Modbus Address	Register Data
11000	0x0064
11001	0x0005
11002	0x0000
11003	0x8000
11004	0xe000

Receiving Responses

All response messages (illustrated in step 4) are returned in Modbus Data Groups (MDGs) and the number of MDGs are determined by the amount of data returned. Each data group is an MBTCP function 16 message generated by the PLX82-MBTCP-PNC for a server that is determined by the IP Address, Acyclic Slave Address and Acyclic Modbus Address parameters configured in the MBTCP Remote Server section of the PLX82-MBTCP-PNC configuration in the ProSoft Configuration Builder (PCB).

For example:

A read response under 236 bytes is returned in a single message. Data greater than 236 bytes may be returned in two or more messages.

We show this here:

- MDG1 can contain data bytes 0 to 235.
- MDG2 contains data bytes 235 to 483, and so on.

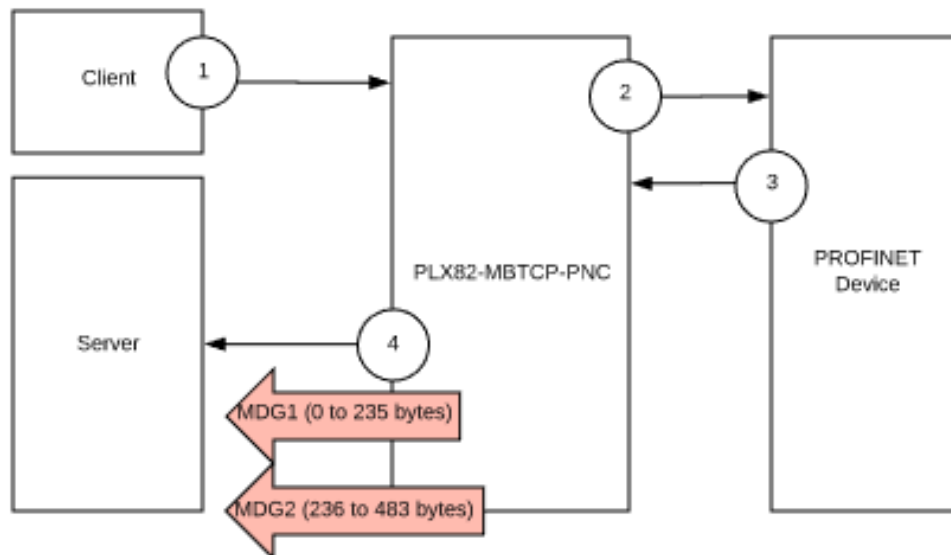

- Modbus Data Group 1 applies to acyclic write responses and acyclic read responses
- The Modbus Index will increment for each acyclic read or write request
- Acyclic read responses may use Modbus Data Groups 1 to 4
- Acyclic read responses that are greater than one Modbus Data Group will have matching Modbus indexes.
- Write responses will not use groups 2 to 4.
- Acyclic write responses do not include any length byte or any data and therefore will not have a need for additional messages other than that contained in Modbus Data Group 1.

The following table illustrates the group elements, Modbus offsets, and data sizes for each group.

Modbus Data Group 1	Group Element	Acyclic Modbus Address Offset	Data Bytes
	Modbus Index	0 This increments for each read or write request.	
	Status	1 This value will either be "1" for OK or "65536" for error.	
	Slave ID	2	
	Slot Number	3	
	Sub Slot Number	4	
	Index	5	
	Length in bytes	6	
	Data	7 to 124 (118 total)	0 to 235
Modbus Data Group 2	Group Element	Acyclic Modbus Address Offset	Data Bytes
	Modbus Index	125 This will match the value of MDG1.	
	Data	126 to 249 (124 total)	236 to 483
Modbus Data Group 3	Group Element	Acyclic Modbus Address Offset	Data Bytes
	Modbus Index	250 This will match the value of MDG1 and MDG2.	
	Data	251 to 374 (124 total)	484 to 731
Modbus Data Group 4	Group Element	Acyclic Modbus Address Offset	Data Bytes
	Modbus Index	375 This will match the value of MDG1, MDG2, and MDG3.	
	Data	376 to 499 (124 total)	732 to 979

6.2 Alarm Data

The PLX82-MBTCP-PNC will notify an MBTCP server that a PROFINET device has generated an alarm. An MBTCP function 16 message is generated by the PLX82-MBTCP-PNC for a server that is determined by the IP Address, Alarm Slave Address, and Alarm Modbus Address parameters configured in the MBTCP Remote Server section of the PLX82-MBTCP-PNC configuration in the ProSoft Configuration Builder (PCB).

The following diagram illustrates acyclic data flow from the PROFINET device through the PLX82-MBTCP-PNC, to the server.

1. PROFINET device sends an alarm to the PLX82-MBTCP-PNC.
2. PLX82-MBTCP-PNC generates a write request message to the server containing the data from the PROFINET device.

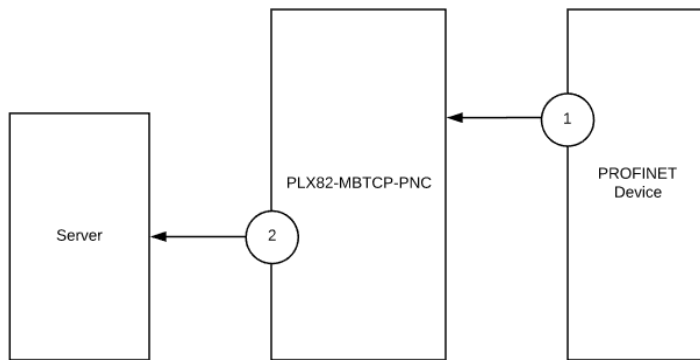

There is only one packet/group for alarms.

Parameter	Alarm Modbus Address Offset	Description
Modbus Index	0	Starts at the Alarm Modbus Address defined in the MBTCP Remote Server section of ProSoft Configuration Builder.
DeviceNumber	1	The device number of the device issuing the alarm.
Slot Number	2	The slot number where the reporting device resides.
Sub-slot Number	3	The sub-slot (if applicable) where the reporting device resides.
Type	4	The type of device.
Priority	5	Alarm priority.
Specifier	6	Alarm specifier
DataSize	7	Size in bytes of the alarm data.
Data	8 to 8 + (Length in bytes + 1_/2-1)	The alarm data.

7 CommonNet Data Map

This is an optional section that allows you to move data already in the PLX82-MBTCP-PNC's internal database to another location in its database and is not required for normal operation. This feature is primarily used to transfer status data from our normally inaccessible upper memory (address 10000 and higher) down into the accessible lower memory (0 to 9999) so that it may be transferred to one or more connected devices.

- 1 From PCB, navigate to **COMMONNET > DATA MAP**.

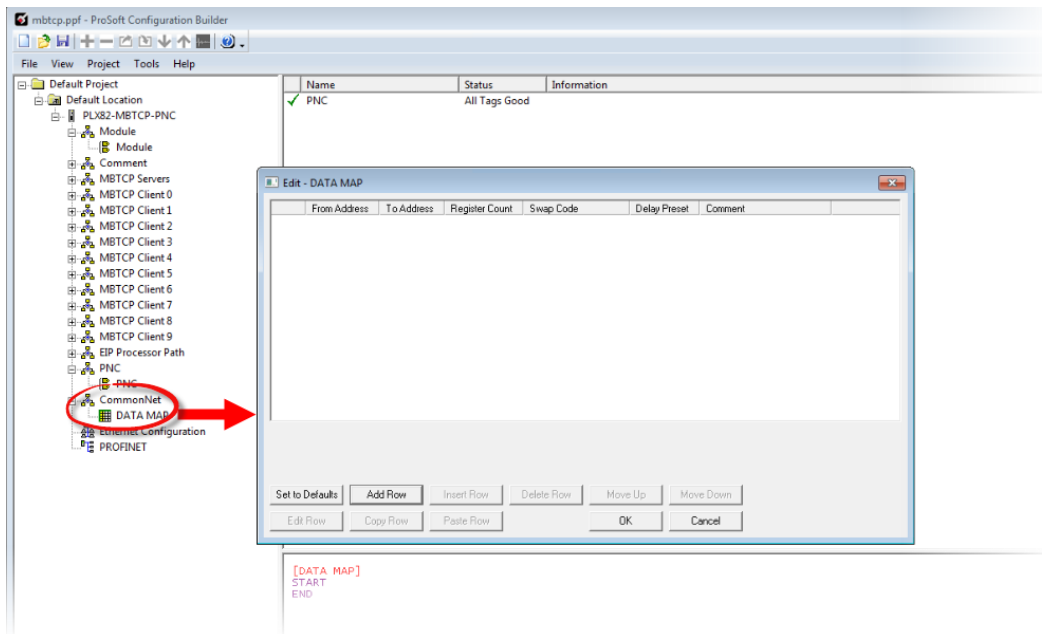

- 2 To set data mapping to default levels, click the **SET TO DEFAULTS** button.

3 To configure the data map, click on the **ADD ROW** button.

Parameter	Description										
From Address	0 to highest Status Data address. Specifies the beginning internal database register address for the copy operation. The address can be any valid address in the user data area or the status data area in the PLX82-MBTCP-PNC.										
To Address	0 to 9999 Specifies the beginning destination register address for the copy operation. This address must always be within the user data area. Make sure you specify a destination address that does not overwrite data that is stored in memory by one of the communication protocols running on the PLX82-MBTCP-PNC.										
Register Count	1 to 100 Specifies the number of registers to copy.										
Swap Code	No Change, Word Swap, Word & Byte Swap, Byte Swap You may need to swap the order of bytes in the registers during the copy process in order to change the alignment of bytes between different protocols. Use this parameter when dealing with floating-point or other multi-register values since there is no standard for storage for this data type in slave devices.										
	<table border="1"> <thead> <tr> <th>Swap Code</th> <th>Description</th> </tr> </thead> <tbody> <tr> <td>No Swap</td> <td>No change is made in the byte ordering (1234 = 1234)</td> </tr> <tr> <td>Word Swap</td> <td>The words are swapped (1234 = 3412)</td> </tr> <tr> <td>Word and Byte Swap</td> <td>The words are swapped, then the bytes in each word are swapped (1234 = 4321)</td> </tr> <tr> <td>Bytes</td> <td>The bytes in each word are swapped (1234 = 2143)</td> </tr> </tbody> </table>	Swap Code	Description	No Swap	No change is made in the byte ordering (1234 = 1234)	Word Swap	The words are swapped (1234 = 3412)	Word and Byte Swap	The words are swapped, then the bytes in each word are swapped (1234 = 4321)	Bytes	The bytes in each word are swapped (1234 = 2143)
Swap Code	Description										
No Swap	No change is made in the byte ordering (1234 = 1234)										
Word Swap	The words are swapped (1234 = 3412)										
Word and Byte Swap	The words are swapped, then the bytes in each word are swapped (1234 = 4321)										
Bytes	The bytes in each word are swapped (1234 = 2143)										
Delay Preset	<p>This parameter sets an interval for each <i>Data Map</i> copy operation. The value for the <i>Delay Preset</i> is not a fixed amount of time. It is the number of firmware scans that must transpire between copy operations.</p> <p>The firmware scan cycle can take a variable amount of time, depending on the level of activity of the protocol drivers running on the gateway and the level of activity on the gateway's communication ports. Each firmware scan can take from one to several milliseconds to complete. Therefore, <i>Data Map</i> copy operations cannot be expected to happen at regular intervals.</p> <p>If multiple copy operations (several rows in the <i>Data map</i> section) happen too frequently, or all happen in the same update interval, they could delay the process scan of the PLX82-MBTCP-PNC protocols, which could result in slow data updates or missed data on communication ports. To avoid these potential problems, set the <i>Delay Preset</i> to different values for each row in the <i>Data Map</i> section and set them to higher, rather than lower, numbers.</p> <p>For example, <i>Delay Preset</i> values below 1000 could cause a noticeable delay in data updates through the communication ports. Do not set all <i>Delay Presets</i> to the same value. Instead, use different values for each row in the Data Map such as 1000, 1001, and 1002 or any other different <i>Delay Preset</i> values you like. This prevents the copies from happening concurrently and prevents possible process scan delays.</p>										

The following parameters are located in the PLX82-MBTCP-PNC upper memory, starting at address 10000.

Parameter	Starting Address	Length (16 bit registers)
Module Status	10000	20
MBTCP Servers	11000	40
MBTCP Client 0 Status	12000	26
MBTCP Client 1 Status	12026	26
MBTCP Client 2 Status	12052	26
MBTCP Client 3 Status	12078	26
MBTCP Client 4 Status	12104	26
MBTCP Client 5 Status	12130	26
MBTCP Client 6 Status	12156	26
MBTCP Client 7 Status	12182	26
MBTCP Client 8 Status	12208	26
MBTCP Client 9 Status	12234	26
PNC Status	13000	594

8 Webpage

The PLX82-MBTCP-PNC webpage is accessible via web browser or through PCB via the built-in ProSoft Discovery Service.

To access the PLX82-MBTCP-PNC webpage, enter the PLX82-MBTCP-PNC IP address into your browser.

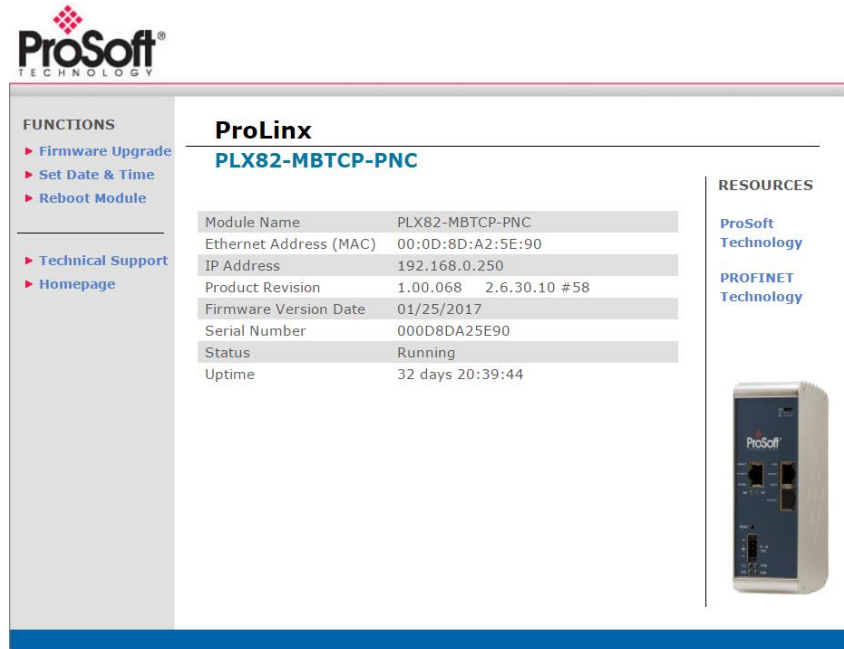

Status

Parameter	Description	Value
Module Name	Name of the device as character string defined by the manufacturer	PLX82-MBTCP-PNC
Ethernet Address (MAC)	The MAC address (=MAC-ID) is the unique (physical) Ethernet address of the device fixed by the manufacturer	Assigned MAC address
IP Address	IP address of the of the PLX82-MBTCP-PNC that can be set via the ProSoft fdt Configuration Manager	xxx.xxx.xxx.xxx
Product Revision	Product revision of the PLX82-MBTCP-PNC firmware	vx.xx.xxx x.x.xx.xx.#1
Firmware Version Date	Firmware Version Date	Month/Day/Year
Serial Number	Serial number of the PLX82-MBTCP-PNC	0 to 65535
Status	Current status of the module	Running, Communicating, Ready, Error
Uptime	Counts up to the time from the last Reset/Power On	Days, hours, minutes, seconds

Functions

Function	Description
Firmware Upgrade	Click to upgrade the PLX82-MBTCP-PNC firmware. Used only if instructed to do so by ProSoft Technology Technical Support.
Set Date & Time	Click to set the PLX82-MBTCP-PNC date and time.
Reboot Module	Click to reboot the PLX82-MBTCP-PNC.
Technical Support	Click to be directed to ProSoft Technology Technical Support.
Homepage	Click to be directed to the PLX82-MBTCP-PNC homepage.

Resources

Resource	Description
ProSoft Technology	Click to be directed to the ProSoft Technology website.
PROFINET Technology	Click to be directed to the PROFINET website.

9 Diagnostics and Troubleshooting

There are three ways to troubleshoot the PLX82-MBTCP-PNC:

- Using the LEDs located on the front of the PLX82-MBTCP-PNC.
- Using the Diagnostics option within ProSoft Configuration Builder (PCB).
- Using the MBTCP port to run diagnostics on the network.

9.1 LEDs

All LEDs are found on the front of the module.



LED	State	Description
Pwr	Off	Power is not connected to the power terminals or source is insufficient to properly power the PLX82-MBTCP-PNC (200mA at 24 VDC is required)
	Solid Green	Power is connected to the power terminals. Verify that the other LEDs for operational and functional status come on briefly after power-up (check for burned-out LEDs).
Flt	Off	Normal operation
	Solid Red	A critical error has occurred. Program executable has failed or has been user-terminated and is no longer running. Press Reset p/b or cycle power to clear error.
Cfg	Off	Normal operation
	Solid Amber	The unit is in configuration mode. Either a configuration error exists, or the configuration file is currently being downloaded or read. After power up, the configuration is read, and the unit implements the configuration values and initiates the hardware. This occurs during power cycle or after the Reset button is pressed.
Err	Off	PROFINET is scanning configured slaves without error.
	Flashing Amber	PROFINET controller is in error (misconfigured or missing slaves)
	Solid Amber	PROFINET controller is not configured, or is incorrectly configured.
NS	Off	Not Used
MS	Off	Not Used
Link/Act	Off	No physical network connection is detected.
	Solid Green	Physical network connection detected. This LED must be ON solid for Ethernet communication to be possible.
100 Mbit (Port Speed)	Off	No activity on the port.
	Flashing Amber	The Ethernet port is actively transmitting or receiving data.
Link	Green	A connection exists
Rx/Tx	Yellow (Flashing)	The device sends/receives Ethernet frames.
SYS	Green	Operating system running
	Green/Yellow	Second stage boot loader is waiting for firmware.
	Yellow	Second stage boot loader missing. Contact Technical Support
	Off	Power supply for the device is missing or hardware is defective
SF	Red (with BF Red)	No valid Controller License
	Red (flashing cyclic at 2 Hz)	System Error: Invalid configuration, watchdog error, or internal error
	Off	No error
BF	Red	No Connection: No Link or together with SF Red: No Controller License
	Red (Flashing cyclic at 2 Hz)	Configuration fault: not all configured I/O devices are connected.
	Off	No error

9.2 PCB Diagnostics

- 1 From PCB, right-click on the **PLX82-MBTCP-PNC** icon and select **DIAGNOSTICS**.

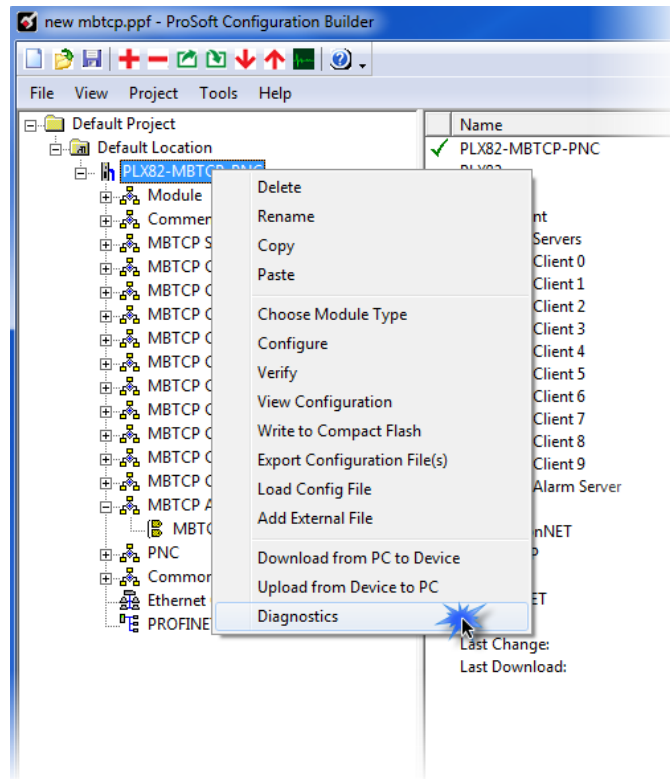

- 2 When the *Diagnostics* window opens, click the **SET UP CONNECTION** icon to browse for PLX82-MBTCP-PNC's IP address.

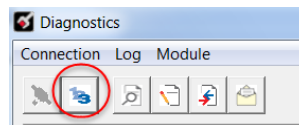

- 3 Enter the IP address of the PLX82-MBTCP-PNC. If you don't remember the IP address, click on the **BROWSE DEVICE(S)** button to display all devices on the network.

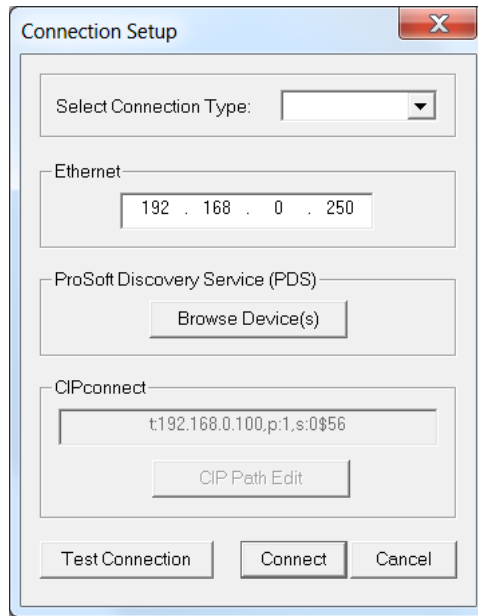

- 4 Click **TEST CONNECTION** to ensure that a connection can be established.
- 5 Click **CONNECT** to obtain diagnostic results. Click on the parameters within the navigation tree on the left pane of the window.

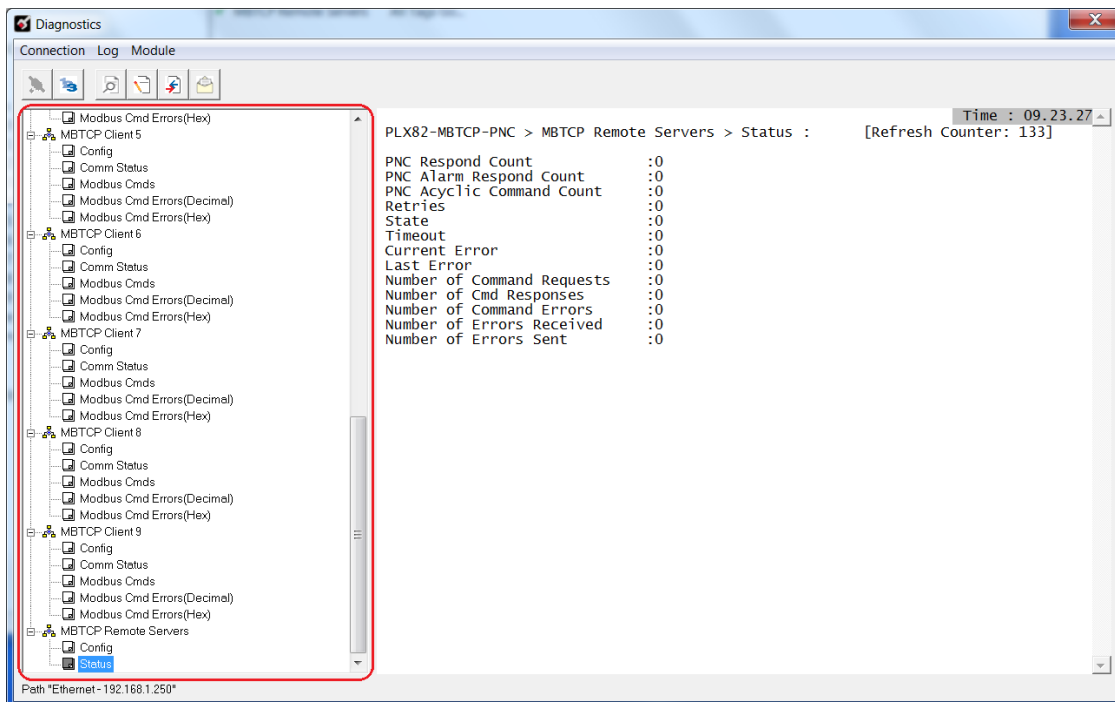

9.2.1 PCB Menu Options

This view provides diagnostic and status information.

PLX82-MBTCP-PNC > Module > Version

Displays the module's current version information as well as additional information such as IP address, free memory, etc.

```
Time : 09.28.39
[Refresh Counter: 8]
PLX82-MBTCP-PNC > MODULE > Version :
PRODUCT NAME           :PLX82-MBTCP-PNC
PRODUCT NAME CODE      :MPNC
SOFTWARE REVISION LEVEL :1.02.001
OPERATING SYSTEM REVISION :2.6.30.10
RUN NUMBER             :#2
MY IP ADDRESS          :192.168.1.250
MY ETHERNET ADDRESS (HEX) :00:0D:8D:A2:5E:90
PROGRAM SCAN COUNTER   :21160257
SYSTEM FREE MEMORY     :49508352
MODULE NAME            :PLX82-MBTCP-PNC
```

PLX82-MBTCP-PNC > Module > Data Map

Displays the PLX82-MBTCP-PNC data map.

```
Time : 09.31.08
[Refresh Counter: 12]
PLX82-MBTCP-PNC > MODULE > Data Map :
DATA MAP LIST           : FROM ADDR   TO ADDR   REG COUNT SWAP CODE
***** Scroll Up/Down *****
```

Database View

Displays database information in ASCII, Decimal, Hex, and Floating Point formats.

PLX82-MBTCP-PNC > PROFINET > Config

Displays the current PCB configuration settings.

```
Time : 09.33.30
[Refresh Counter: 11]
PLX82-MBTCP-PNC > PROFINET > Config :
Start Input Byte Offset : 4000
Start Output Byte Offset : 0
Swap Read Input Data Bytes : No Swap
Swap Read Output Data Bytes : No Swap
Configuration Error      : 0
```

PLX82-MBTCP-PNC > PROFINET > Module Information

Displays specific module information.

```
Time : 09.38.01
[Refresh Counter: 11]
PLX82-MBTCP-PNC > PROFINET > Module Information :
Module Information      :
Module                  : PROFINET IO Controller
Version                 : 2.7.11 build 0
Device Number           : 20001
Serial Number           : 9043110
```

PLX82-MBTCP-PNC > PROFINET > Module Input Map

Displays the starting input data address and the size of the data (bytes) being passed.

```
Time : 09.39.40
PLX82-MBTCP-PNC > PROFINET > Module Input Map : [Refresh Counter: 26]
Input Module 0 TO 0 : INPUT_START INPUT_COUNT (32)
Module 0 : 0 32
***** Scroll Up/Down *****
```

PLX82-MBTCP-PNC > PROFINET > Module Output Map

Displays the starting output data address and the size of the data (bytes) being passed.

```
Time : 09.46.33
PLX82-MBTCP-PNC > PROFINET > Module Output Map : [Refresh Counter: 268]
Output Module 0 TO 0 : OUTPUT_START OUTPUT_COUNT (32)
Module 0 : 0 32
***** Scroll Up/Down *****
```

PLX82-MBTCP-PNC > PROFINET > Status

Displays the current PROFINET status.

```
Time : 10.30.05
PLX82-MBTCP-PNC > PROFINET > Status : [Refresh Counter: 6]
Number of Input Messages : 33231
Input Error Count : 0
Previous Input Error : 0
Current Input Error : 0
Number of Output Messages : 33231
Output Error Count : 0
Previous Output Error : 0
Current Output Error : 0
Connection Count : 1
Communication Status : Connected
```

PLX82-MBTCP-PNC > MBTCP Server > Server Config

Displays the parameters configured within PCB for the MBTCP Server.

```
Time : 10.35.04
PLX82-MBTCP-PNC > MBTCP Server > Server Config : [Refresh Counter: 51]
Offsets : BitIn=0 WordIn=0 Output=0 Holding=0
Floating-point Data : Flag=N Start=7000 Offset=0
Connection Timeout : 600
```

PLX82-MBTCP-PNC > MBTCP Server > Comm Status

Displays the communication status of the MBTCP and MBAP servers.

```
PLX82-MBTCP-PNC > MBTCP Server > Comm Status : [Refresh Counter: 54] Time : 10.38.01
MBTCP SERVER (Port 2000) :
  Number of Requests :0
  Number of Responses :0
  Number of Errors Received :0
  Number of Errors Sent :0
MBAP SERVER (Port 502) :
  Number of Requests :0
  Number of Responses :0
  Number of Errors Received :0
  Number of Errors Sent :0
```

PLX82-MBTCP-PNC > MBTCP Client x > Config

Displays the current configuration of each the selected MBTCP client.

```
PLX82-MBTCP-PNC > MBTCP Client 0 > Config : [Refresh Counter: 5] Time : 10.40.51
(CLIENT 0) :
  Commands :0
  Min Dly :0
  Resp TMO :1000
  Retries :0
  Floating-point Data : Flag=N Start=7000 offset=0
  MBAP Port Override :N
  Err Delay :0
```

PLX82-MBTCP-PNC > MBTCP Client x > Comm Status

Displays the comm status of the selected MBTCP client.

```
PLX82-MBTCP-PNC > MBTCP Client 0 > Comm Status : [Refresh Counter: 8] Time : 10.47.52
MBTCP CLIENT 0 STATUS :
  Retries :0
  Cur Cmd :0
  State :0
  Cfg Err :0x0000
  Cur Err :0
  Last Err :0
  Number of Command Requests :0
  Number of Cmd Responses :0
  Number of Command Errors :0
  Number of Requests :0
  Number of Responses :0
  Number of Errors Received :0
  Number of Errors Sent :0
```

PLX82-MBTCP-PNC > MBTCP Client x > Modbus Cmds

Displays the Modbus command list for the selected MBTCP client. The first column displays each command.

```

Time : 10.52.18
PLX82-MBTCP-PNC > MBTCP Client 0 > Modbus Cmds : [Refresh Counter: 88]
COMMAND LIST FOR CLIENT 0 : EN MBREG POLLINT COUNT SWAP IP ADDRESS PORT
C0 : 0 0 0 0 0 0
C1 : 0 0 0 0 0 0
C2 : 0 0 0 0 0 0
C3 : 0 0 0 0 0 0
C4 : 0 0 0 0 0 0
C5 : 0 0 0 0 0 0
C6 : 0 0 0 0 0 0
C7 : 0 0 0 0 0 0
C8 : 0 0 0 0 0 0
C9 : 0 0 0 0 0 0
C10 : 0 0 0 0 0 0
C11 : 0 0 0 0 0 0
C12 : 0 0 0 0 0 0
C13 : 0 0 0 0 0 0
C14 : 0 0 0 0 0 0
C15 : 0 0 0 0 0 0
    
```

PLX82-MBTCP-PNC > MBTCP Client x > Modbus Cmd Errors (Dec)

Lists Modbus command errors in decimal format.

```

Time : 13.12.59
PLX82-MBTCP-PNC > MBTCP Client 0 > Modbus Cmd Errors(Decimal) : [Refresh Counter:
D0 : 0 0 0 0 0 0 0
D10 : 0 0 0 0 0 0 0
    
```

PLX82-MBTCP-PNC > MBTCP Client x > Modbus Cmd Errors (Hex)

Lists Modbus command errors in hexadecimal format.

```

Time : 13.16.36
PLX82-MBTCP-PNC > MBTCP Client 0 > Modbus Cmd Errors(Hex) : [Refresh Counter: 67]
H0 : 0000 0000 0000 0000 0000 0000 0000 0000 0000 0000
H10 : 0000 0000 0000 0000 0000 0000
    
```

PLX82-MBTCP-PNC > MBTCP Remote Servers > Config

Displays the MBTCP server alarm configuration.

```

PLX82-MBTCP-PNC > MBTCP Remote Server > Config :      [Refresh Counter: 68]
IP Address           : 192.168.1.5
Serv Port            : 502
Alarm Slave Address  : 1
Alarm Modbus Address : 1000
Acyclic Slave Address : 2
Acyclic Modbus Address : 2000
  
```

Parameter	Description
IP Address	IP address of the Modbus TCP/IP server that will receive the PROFINET acyclic responses and alarm information.
Serv Port	Service Port 502 or other supported ports on server command. A value of 502 addresses Modbus TCP/IP servers that are compatible with the Schneider Electric MBAP specifications (most devices). If a server implementation supports another service port, it will appear here.
Alarm Slave Address	1 to 255. Specifies the Modbus slave node address on the network that the PROFINET alarm information will be written to. Most Modbus devices only accept an address in the range of 1 to 247 so use caution. If the value is set to 0, the command will be a broadcast message on the network. The Modbus protocol permits broadcast commands for write operations.
Alarm Modbus Address	Specifies the starting Modbus register to place alarm info.
Acyclic Slave Address	1 to 255. This parameter specifies the Modbus slave node address on the network that will receive the PROFINET acyclic response information. Most Modbus devices only accept an address in the range of 1 to 247 so use caution. If the value is set to 0, the command will be a broadcast message on the network. The Modbus protocol permits broadcast commands for write operations. Do not use this node for Read operations.
Acyclic Modbus Address	Specifies the starting Modbus register to place acyclic responses from the PROFINET device.

PLX82-MBTCP-PNC > MBTCP Remote Servers > Status

Displays MBTCP Remote Server status information.

```

Time : 13.34.00
PLX82-MBTCP-PNC > MBTCP Remote Servers > Status : [Refresh Counter: 25]
PNC Respond Count :0
PNC Alarm Respond Count :0
PNC Acyclic Command Count :0
Retries :0
State :0
Timeout :0
Current Error :0
Last Error :0
Number of Command Requests :0
Number of Cmd Responses :0
Number of Command Errors :0
Number of Errors Received :0
Number of Errors Sent :0
  
```

Parameter	Description
PNC Respond Count	Total number of PROFINET responses saved in the queue.
PNC Alarm Respond Count	Total number of PROFINET Alarm Responses saved in the queue.
PNC Acyclic Command Count	Total number of PROFINET acyclic commands saved in the queue.
Retries	Number of messages sent but exceeded the 100ms timeout and had to be retried
State	Displays the current command state: -1: Prepare socket for connection to server 0: Try to open connection to server 10: Verify that the connection has been established successfully 1: Check for delay before building command (Not used in PNC) 2: Delay command for configured length of time (Not used in PNC) 3: Build the command 7: Select the next command in the queue 8: Verify valid command (Not used in PNC) 100: Close socket (Not used in PNC) 1002: Move to next command and open a new socket (Not used in PNC) 1003: Close socket without error status (Not used in PNC)
Timeout (milliseconds)	Amount of time before trying to reconnect to the socket to retry the send.
Current Error	Current error code number detected by the module.
Last Error	Previous error code detected by the module.
Number of Command Requests	This value is incremented each time a Command Request is issued by the client.
Number of Cmd Responses	This value is incremented each time a Command Response is received by the client.
Number of Command Errors	This value is incremented each time an error message is received from a remote unit or a local error is generated for a command.
Number of Errors Received	Number of errors received from the PNC.
Number of Errors Sent	Number of errors sent from the PNC.

9.2.2 PROFINET General Status Codes

Status Code	Description
0x0000000L	Operation successful
0xC000001L	Common error, detailed error information optionally present in the data area of the packet
0xC000002L	Unexpected failure
0xC000003L	Out of memory
0xC000004L	Unknown command in packet received
0xC000005L	Unknown destination in packet received
0xC000006L	Unknown destination ID in packet received
0xC000007L	Packet length is invalid
0xC000008L	Invalid extension in packet received
0xC000009L	Invalid parameter in packet found
0xC00000CL	Watchdog error occurred
0xC00000DL	List type is invalid
0xC00000EL	Handle is unknown
0xC00000FL	A packet index is not in the expected sequence
0xC000010L	The amount of fragmented data contained in the packet sequence is too large
0xC000011L	The packet done function has failed
0xC000012L	A packet failed to send
0xC000013L	Packet request from packet pool has failed
0xC000014L	Release of a packet from the packet pool has failed
0xC000015L	The get packet pool load function has failed.
0xC000016L	The get queue load function failed
0xC000017L	The waiting for a packet from queue failed
0xC000018L	The posting of a packet has failed
0xC000019L	The peek of a packet from queue has failed
0xC00001AL	Request already running
0xC00001BL	Creating a timer failed
0xC0000100L	General initialization fault
0xC0000101L	Database access failure
0xC0000102L	Controller parameter cannot activate at state operate
0xC0000103L	Slave parameter cannot activate at state operate
0xC0000200L	Watchdog time is out of range
0xC0000201L	Application is already registered
0xC0000202L	No application registered
0x0000F005L	Fragment accepted
0xC000F006L	Reset required

9.2.3 PROFINET Device Errors

Error Code	Description
D13 to D31	Unused, set to zero
D12	Inactive module present
D11	Module DiffBlock present
D10	Packet too small
D9	Diagnosis buffer overwritten
D8	Diagnosis buffer overflow
D7	Diagnosis - disappeared
D6	Diagnosis data present for I/O device
D5	IO - Device deactivated
D4	IO - Device parameter fault
D3	IO - Device invalid response
D2	IO - Device configuration fault
D1	IO - Device not ready
D0	IO - Device does not exist

9.2.4 Acyclic Read/Write Communication Status

Status Code	Description
0x00000000	Status OK
0xC00A0012	Insufficient memory for this request
0xC00A0014	This request cannot be served in current CMCTL state
0xC00A0018	Error while sending a packet to another task
0xC00A0040	The CMCTL protocol-machine restored from index invalid
0xC00A0041	The index of CMCTL protocol machine is invalid
0xC00C0030	Too many outstanding RPC-requests for this I/O device
0xC00C0031	Error while sending internal message to another task
0xC00C0032	The handle used for I/O device is wrong
0xC00C0051	The current bus state is OFF and no frames can be sent
0xC02E0100	Generic RPC error code. See Acyclic Read/Write PNIO Remote Procedure Call Status code for details.
0xC02E0200	Error while sending internal message to another task
0xC02E0201	Creating a TLR-Timer-packet in RPC task failed due to insufficient memory
0xC02E0605	The handle to RPC-client instance is invalid
0xC02E0606	The maximum amount of outstanding RPC-Requests for this RPC-Clients instance is reached
0xC02E0607	RPC-client instances can only to connect to an IO-Device if there are no outstanding RPC Requests. There is currently at least one RPC-Request outstanding
0xC02B0024	The message ID of the request is incorrect; out of sequence

9.2.5 Acyclic Read/Write PNIO Remote Procedure Call Status

Status Code	Description
0x00000000	Status OK
0xC02E0010	Initiating CLRPC - Client failed
0xC02E0011	Initiating CLRPC - Server failed
0xC02E0012	Initiating CLRPC - Endpoint Mapper failed
0xC02E0013	Creating message queue failed
0xC02E0014	Identifying Irv_EDD failed
0xC02E0015	Getting the MAC address failed
0xC02E0100	Generic RPC-error code. See Acyclic Read/Write Communication Status for details
0xC02E0101	There was not enough memory allocated to receive the entire I/O device's Connect Response PDU. Most likely, it contains a very large ModuleDiff-Block
0xC02E0102	The fatal error callback function is already registered
0xC02E0200	Error while sending an internal message to another task
0xC02E0201	Creating a TLR-Timer-packet in RPC task failed due to insufficient memory
0xC02E0202	The reference counter value is invalid
0xC02E0203	The port handle is invalid
0xC02E0204	The soft timer is already active (expected inactive)
0xC02E0300	The parameter "uiMaxReg" (maximum amount of RPC mapper registrations) is invalid
0xC02E0301	The requested endpoint mapper index is invalid
0xC02E0303	The state of endpoint mapper is invalid for this request
0xC02E0304	The endpoint mapper is waiting for close confirmation and therefore it's status is invalid for this request
0xC02E0305	The status of endpoint mapper is unknown
0xC02E0306	The status of endpoint mapper is not "Ready"
0xC02E0307	Invalid parameter
0xC02E0308	CLRPC_EPMap_Deregister_req() is not allowed because at least one RPC server is registered to this endpoint mapper
0xC02E0400	An error occurred during server initialization
0xC02E0401	The maximum number of registered RPC-Servers is exceeded or the maximum number of outstanding requests is exceeded
0xC02E0402	Creating TLR timer for RPC server failed
0xC02E0403	There is no RPC server registered that could be de-registered
0xC02E0405	The handle to endpoint mapper is invalid
0xC02E0406	The status of endpoint mapper is invalid
0xC02E0407	The handle to RPC server instance is invalid
0xC02E0408	There is at least one object register to the RPC server instance; CLRPC_ServerDeregister_req() cannot proceed
0xC02E0409	Invalid parameter "ulMaxRecv" in request packet
0xC02E040A	Invalid parameter "ulMaxSend" in request packet
0xC02E040B	Invalid RPC server element "ptElem". Internal RPC error
0xC02E040C	The RPC request was canceled

Status Code	Description
0xC02E040D	The state of RPC server is invalid for this request
0xC02E040E	The activity has already been initialized
0xC02E040F	The RPC server received in invalid (unexpected) response packet
0xC02E0501	The handle to the RPC server instance is invalid
0xC02E0502	The status of the RPC server is invalid
0xC02E0503	The handle of the RPC Object instance is invalid
0xC02E0600	One of the parameters "uiMaxReg" or "uiMaxReq" is invalid
0xC02E0601	The maximum number of parallel RPC client instances has been reached
0xC02E0602	Creating TLR timer for RPC client instance failed
0xC02E0604	The state of endpoint mapper is invalid for this request
0xC02E0605	The handle to the RPC client instance is invalid
0xC02E0606	The maximum amount of outstanding RPC requests for this RPC client instance has been reached
0xC02e0607	RPC client instances can only connect to an I/O device if there are no outstanding RPC requests. Currently, at least one RPC request is outstanding
0xC02E0608	The RPC client instance you tried to use is going to deregister right now. Aborting your request!
0xC02E0609	Invalid RPC client instance element "ptElem". Internal RPC error
0xC02E060A	The LONG timeout TLR timer for an outstanding RPC request hit. Used internally by RPC only
0xC02E060B	Invalid sequence number in RPC message receive by RPC client instance
0xC02E060C	Canceling a running request timeout out. This RPC client is no longer usable
0xC02E060D	The RPC client did not have a packet to return
0xC02E060E	The RPC client received a request with an unexpected flag value.
0xC02E060F	The request was aborted because the RPC client was unbound
0xC02E0610	The maximum resend number was reached by the activity.

9.3 Network Diagnostics

There may be instances where you want to look at diagnostic information on a particular network device. You can access device diagnostics through the MBTCP port of the PLX82-MBTCP-PNC.

- 1 From PCB, click on the **PROFINET** icon.

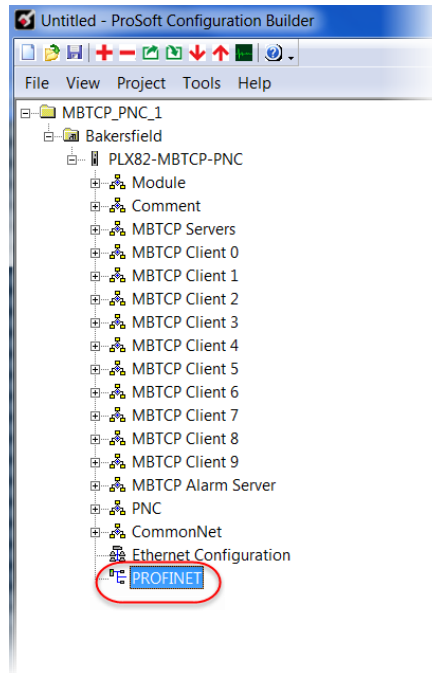

- 2 This launches the ProSoft fdt Configuration Manager application.

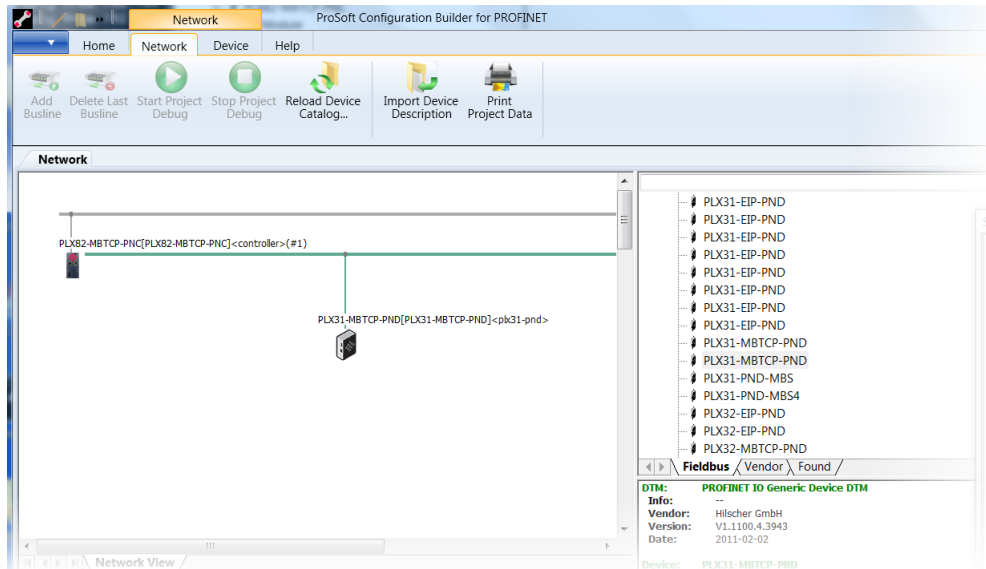

- 3 In the *Solution Explorer* pane, double-click on **NETX DRIVER**.

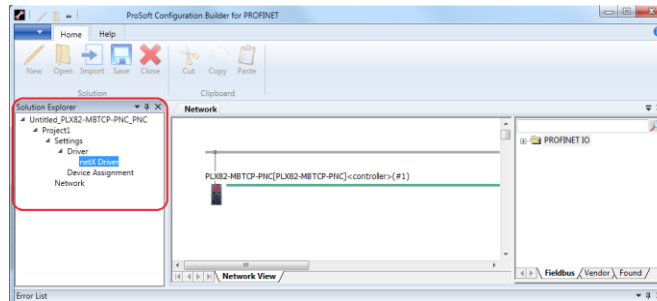

- 4 A *netX Driver* tab appears to the right of the *Network* tab. Click the **NETX DRIVER** tab to open the *TCP Connection* page.

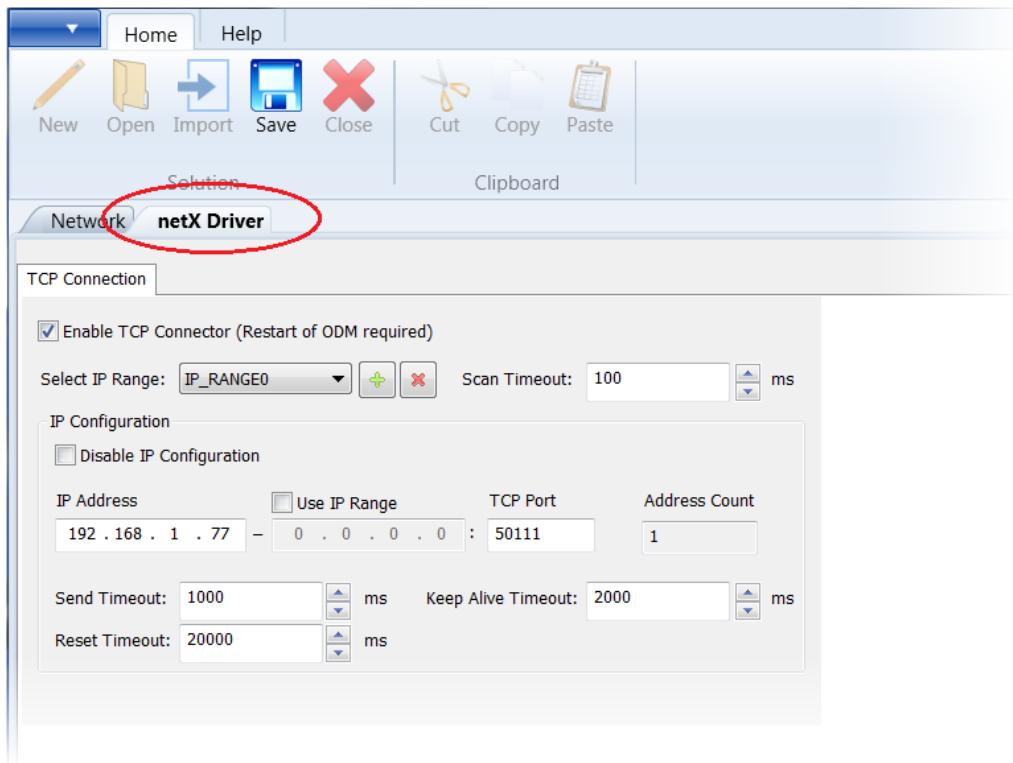

- 5 The netX Driver is used to connect *ProSoft fdt Configuration Manager* configuration software to the device via a TCP/IP connection.
- 6 Ensure that the *Enable TCP Connector* parameter is selected. With the *Enable TCP Connector* box checked, the netX Driver can communicate with other devices via the TCP/IP interface. If *Enable TCP Connector* is not set (checked), the ODM server must be started in order for the new settings to be valid.
- 7 Enter the IP address of the MBTCP port of the PLX82-MBTCP-PNC.
- 8 Click **SAVE**.

OR

- 1 Check the **USE IP RANGE** checkbox.
- 2 Enter a starting IP address and an ending IP address range.
- 3 Click the **SAVE** icon.

Parameter	Task
Enable TCP Connector (Restart of ODM required)	<p>Checked: Communication between the software and the device via TCP/IP can occur.</p> <p>Unchecked: Communication between the software and the device via TCP/IP cannot occur.</p> <p>Note: <i>If the checkmark for for this setting is set or removed, the ODM server must be restarted.</i></p>
Select IP Range	This allows existing IP ranges to be selected. Use the "+" symbol to add an additional IP range or the "x" symbol to remove an IP range.
Scan Timeout	<p>Specifies how long to wait for a response that indicates session establishment.</p> <p>10 to 10,000 ms. The default is 100 ms.</p>
Disable IP Range	<p>Checked: No connection</p> <p>Unchecked: the netX Driver tries to establish a connection using the configured TCP/IP interface.</p>
IP Address (Left)	<p>Enter the IP address of the device (when <i>Use IP Range</i> is not checked)</p> <p>Enter the start address of the IP scanning range if <i>Use IP Range</i> is checked.</p>
Use IP Range	Checked: An IP address range is used.
IP Address (Right)	Enter the ending address of the IP scanning range (if <i>Use IP Range</i> is checked)
Address Count	Displays the scanning range address count, depending on the selected IP-start or IP-end address.
TCP Port	Identifies the endpoint of a logical connection or addresses a specific endpoint on the device or PC.
Send Timeout	<p>Maximum time before the transfer of the transmission data is canceled when the send process fails. For example, the transfer buffer is full.</p> <p>100 to 60,000 ms</p> <p>Default (TCP/IP) is 2000 ms.</p>
Reset Timeout	<p>Maximum time for a device reset, including the reinitialization of the physical interface used for the communication.</p> <p>100 to 60,000 ms</p> <p>Default (TCP/IP) is 2000 ms</p>
Keep Alive Timeout	The Keep-Alive mechanism is used to monitor whether the connection to the device is active. Connection errors are detected using a periodic heartbeat mechanism. This mechanism is initiated after the set time has elapsed if the communication has failed.
Restore	Resets all settings in the configuration dialog to the default values.
Save	Save all settings made in the configuration dialog for the selected connection type.
Save All	Save all settings made in the configuration dialog for all connection types.

- 1 From the *Solution Explorer* dialog box, double-click **DEVICE ASSIGNMENT**.

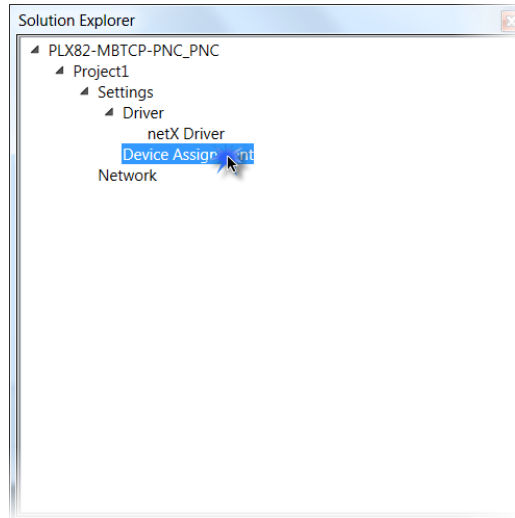

- 2 Click on the **DEVICE ASSIGNMENT** tab and then click **SCAN**. The system scans for all devices that can be connected to the ProSoft fdt Configuration Manager software.

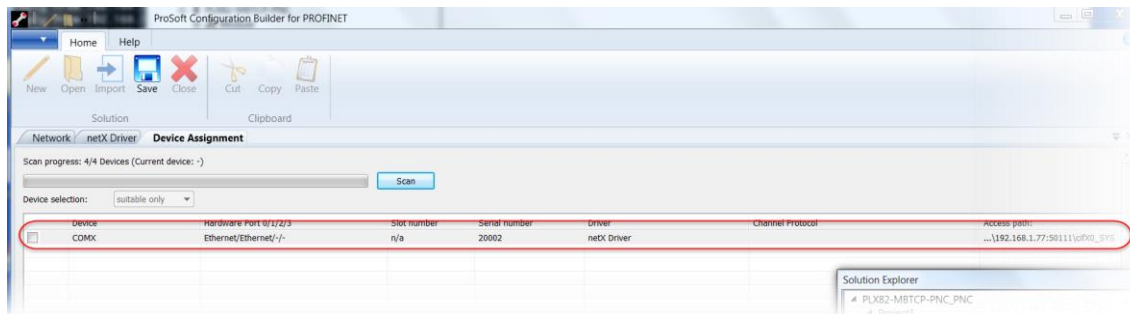

Parameter	Description
Device Selection	Select <i>suitable only</i> or <i>all devices</i>
Device	Device class of the PROFINET device devices
Hardware Port 0/1/2/3	Indicates which hardware is assigned to each communication interface
Slot Number	Not applicable
Serial Number	Serial number of the device
Driver	Name of the driver
Channel Protocol	Displays which firmware is loaded to a channel.
Access Path	Access path to different data to devices. Displays the IP address and port of the device. Also displays the channel number 0 to 3 CH[0to3]

- 3 Select the appropriate device by clicking the checkbox. This is the MBTCP device within the PLX82-MBTCP-PNC.

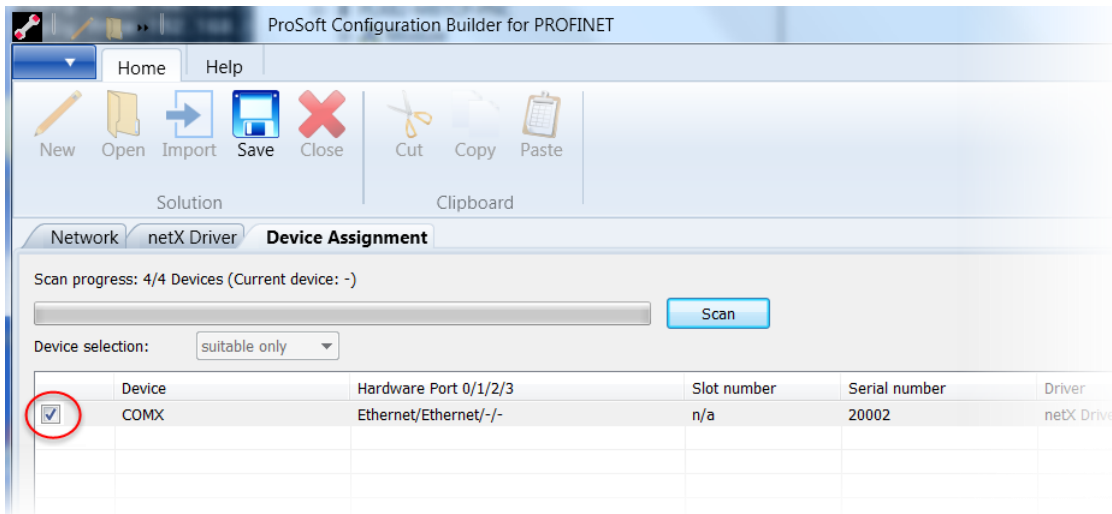

- 4 Click the **SAVE** icon.

9.3.1 Establishing a Diagnostic Connection

Once you have configured the *netx Driver* and *Device Assignments*, you can create a TCP connection between your PC and the PLX82-MBTCP-PNC.

- 1 From the ProSoft fdt Configuration Manager page, click the **NETWORK** tab.

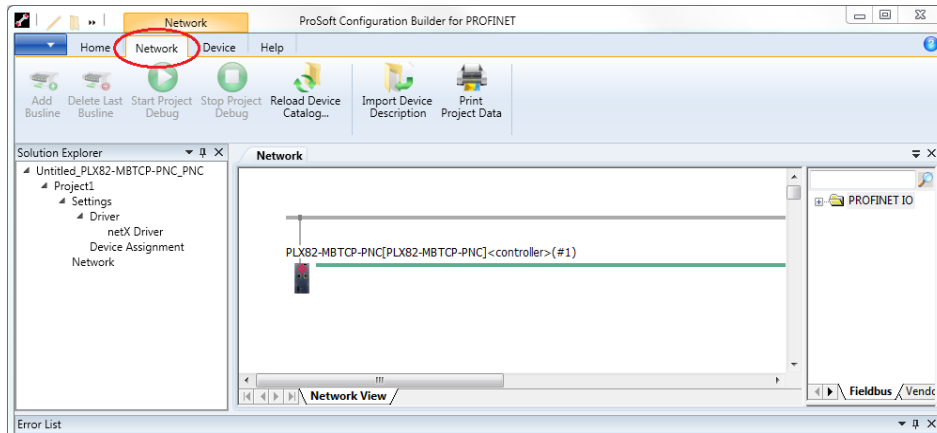

- 2 Right-click on the **PLX82-MBTCP-PNC** icon, and select **CONNECT**. You can also click on the **CONNECT** icon at the top of the page.

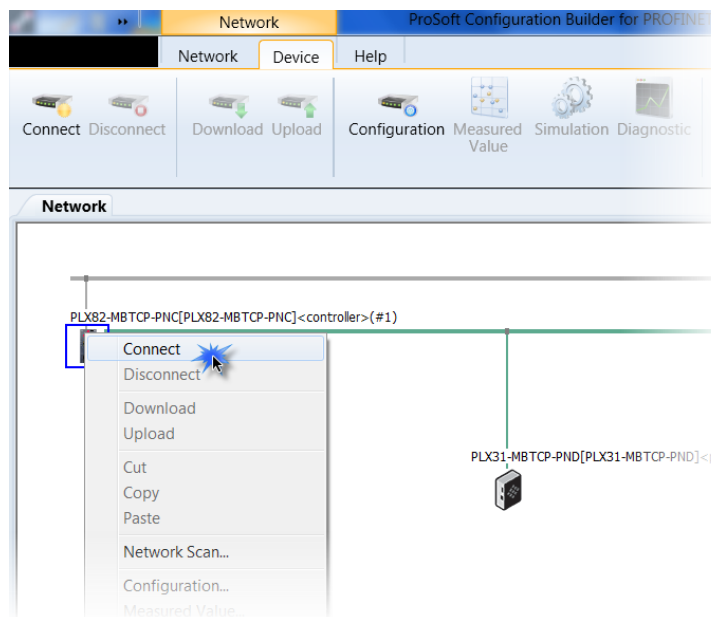

- 3 The module information located above the icon is highlighted in green once the connection is established.

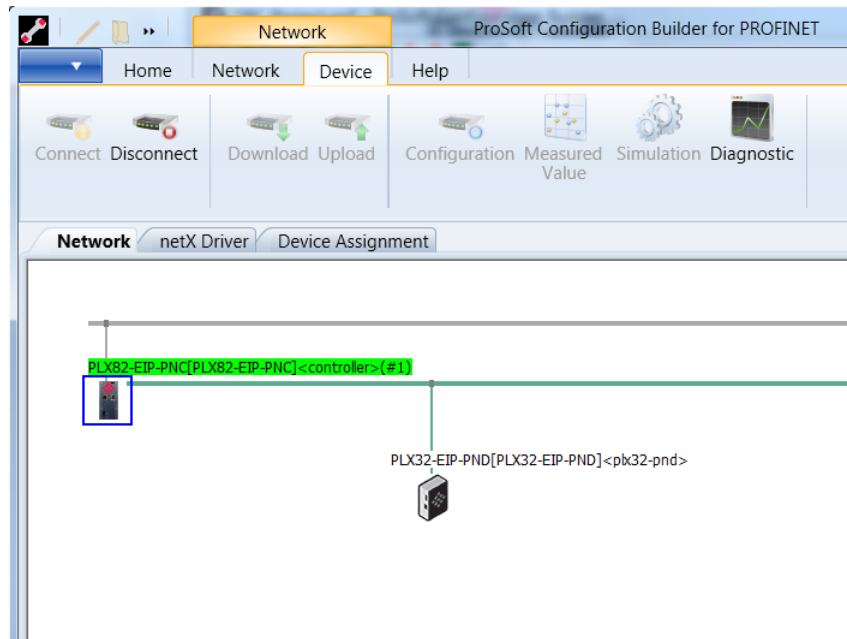

- 4 Right-click on the **PLX82-MBTCP-PNC** icon and select **DIAGNOSIS**.

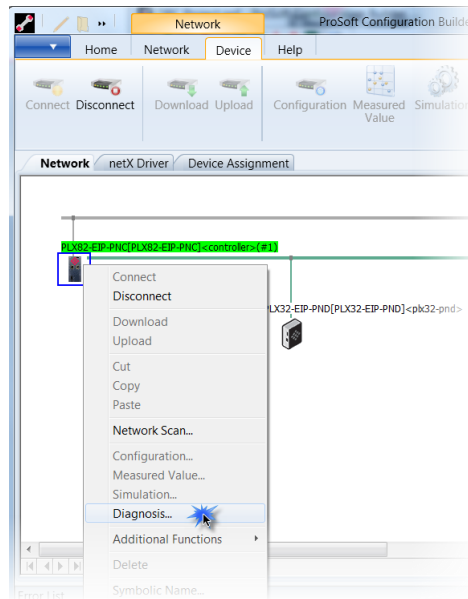

5 The *Diagnostic* pane opens with *General Diagnosis* information displayed.

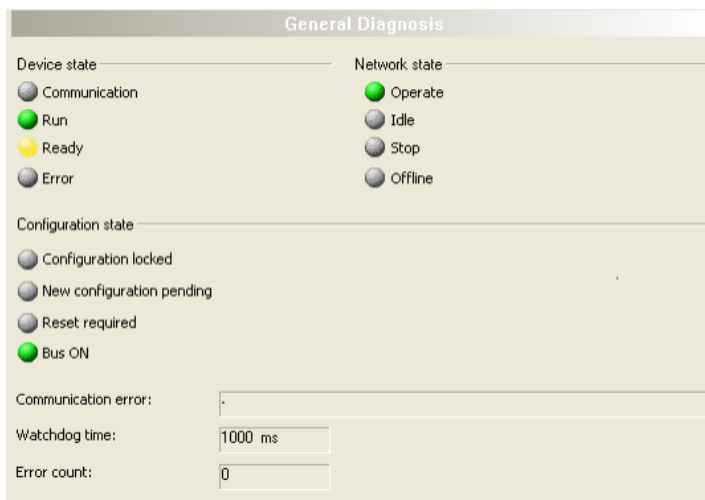

9.3.2 General Diagnosis

The *General Diagnosis* pane provides information on the device state as well as other general diagnostic parameters.

LED	Description	Color
Device State		
Communication	Indicates whether the PROFINET device executes during network communication.	Green - In communication state Gray - Not in communication state
Run	Indicates whether the PROFINET device has been configured correctly	Green - Configuration OK Gray - Incorrect configuration
Ready	Indicates whether the PROFINET device has been started correctly. The PROFINET device waits for a configuration.	Yellow - Device is Ready Gray - Device is not ready
Error	Indicates whether the PROFINET device recorded a device status error (see <i>Extended Diagnosis</i>)	Red - Error Gray - No Error
Network State		
Operate	Indicates whether the PROFINET device is in data exchange. In a cyclic data exchange, the input or output data is transmitted to the PROFINET device.	Green - In Operation state Gray - Not in Operation state
Idle	Indicates whether the PROFINET is in Idle state	Yellow - In Idle state Gray - Not in Idle state
Stop	Indicates whether the PROFINET device is in Stop state. There is no cyclic data exchange on the PROFINET network. The PROFINET device was stopped by the application program, or it changed the Stop state because of a bus error.	Red - In Stop State Gray - Not in Stopped state
Offline	The PROFINET device configuration is offline as long as it does not have a valid configuration.	Yellow - In Offline state Gray - Not in Offline state
Configuration State		
Configuration locked	Indicates whether the PROFINET device configuration is locked to avoid configuration data writeover.	Yellow - Configuration locked Gray - Configuration not locked
New Configuration pending	Indicates whether a new PROFINET device configuration is available.	Yellow - New configuration pending Gray - No new configuration pending
Reset Required	Indicates whether a firmware reset is required as a new PROFINET device has been loaded into the device	Yellow - Reset required Gray - No reset required
Bus On	Indicates whether the bus communication was started or stopped (i.e., whether the device is active on the bus or not bus communication to the device is possible and no response messages are sent	Green - Bus On Gray - Bus Off

Communication Error - Displays the name of the communication error. If the cause of the error is resolved, the value is set to zero again.

Watchdog Time - Displays the watchdog time in ms.

Error Count - This field holds the total number of errors detected since power-up. The protocol stack contains all sorts of errors in this field, regardless of whether they were network related or caused internally.

9.3.3 Master Diagnosis

The *Master Diagnosis* dialog provides the slave state, slave errors, and slaves configured active or in diagnostic mode.

Master Diagnosis	
Slave state	failed
Slave error log indicator	available
Configured slaves	2
Active slaves	0
Slaves with diagnostic	2

Parameter	Description
Slave state	Indicates whether the current slave state is OK. The slave state field indicates whether the Master is in cyclic data exchange to all configured slaves. In the event that there is at least one slave missing, or if the slave has a diagnostic request pending, the status is set to Failed. For protocols that support non-cyclic communication only, the slave state is set to OK as soon as a valid configuration is found. Values: Undefined, OK, Failed
Slave error log indicator	Indicates whether the Slave Error Log indicator is available. The Error Log Indicator field holds the number of entries in the internal error log. If all entries are read from the log, the field is set to zero. Values: Empty, Available
Configured slaves	Displays the number of configured slaves. Number of configured slaves on the network according to the slave list derived from the configuration database created by the configuration software. This list includes the slaves to which the master has to open a connection.
Active Slaves	Displays the number of active slaves. Number of slaves in data exchange mode. The list includes the slaves to which the master has successfully opened a connection.
Slaves with diagnostic	Displays the number of slaves with diagnostic. The number of slaves with diagnostic or errors.

9.3.4 Station Diagnosis

The *Station Diagnosis* dialog displays the current status of all slaves.

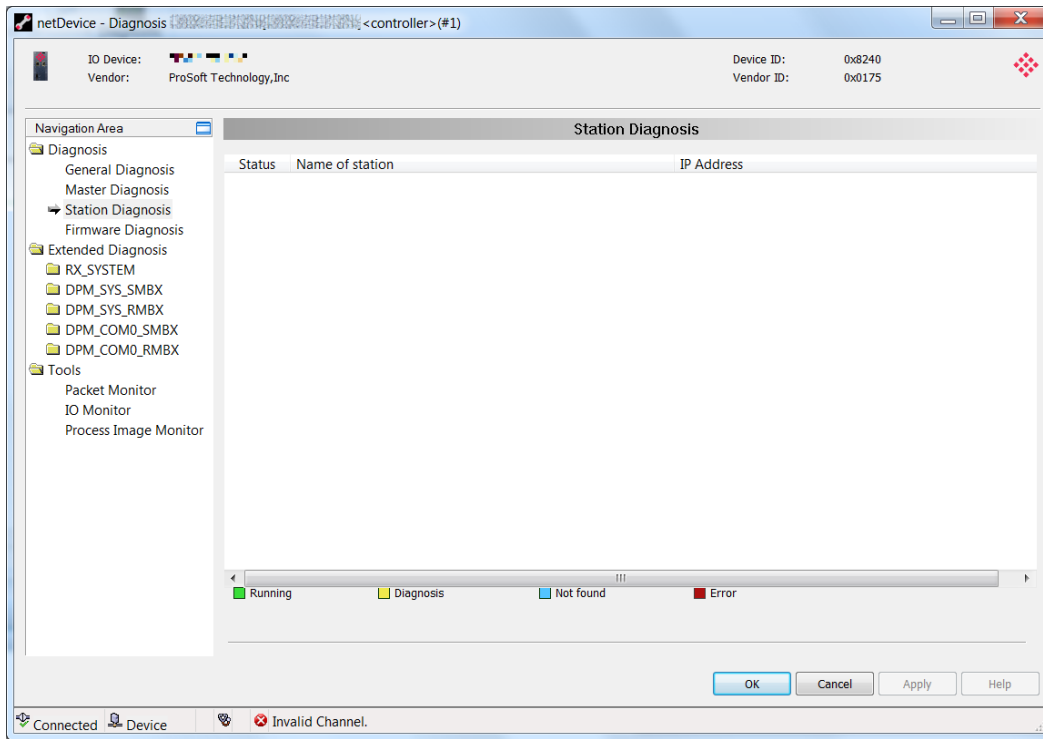

Parameter	Description
Status	Green - Running Yellow - Diagnosis state Blue - Not found Red - Error
Name of Station	Name of slave device
IP Address	IP Address of slave device

9.3.5 Firmware Diagnosis

The *Firmware Diagnosis* dialog displays task diagnosis information of the firmware.

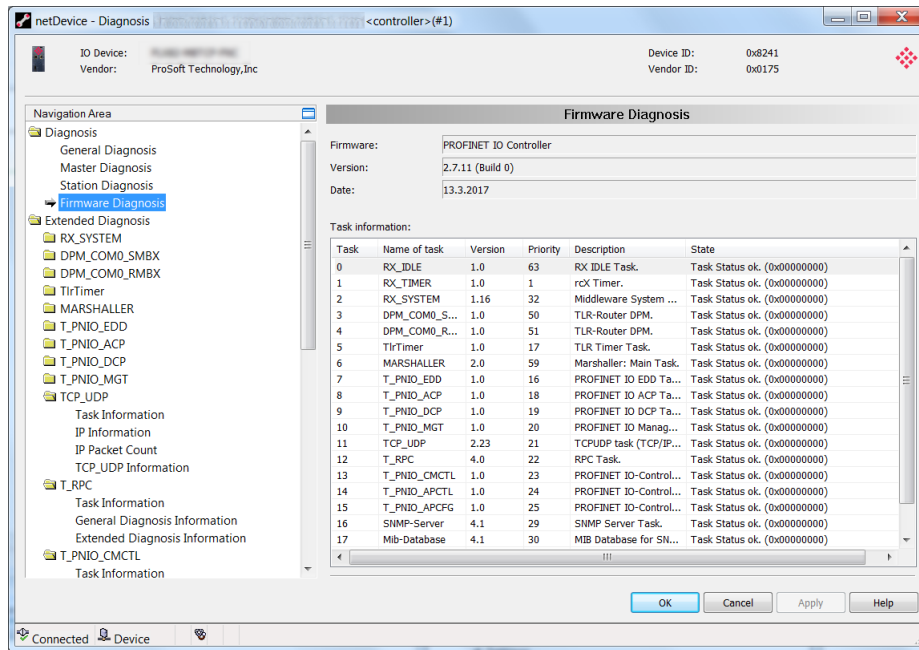

Firmware: Name of the most current firmware.

Version: This number represents the stack version, not the firmware version of the module. The firmware version of the module is shown on the module web service.

Date: Displays the date of the PROFINET stack version.

Parameter	Description
Task	Displays the task number
Name of task	Displays the name of the actual task
Version	Version of the task
Priority	Displays the priority of the task
Description	Displays the description of the task
Status	Status of the task

9.3.6 Extended Diagnosis

The *Extended Diagnosis* dialog contains a list of diagnosis structures such as online counter, states, and parameters. Access requires an online connection between the ProSoft fdt Configuration Manager and the PROFINET Controller.

Folder	Contains
RX_SYSTEM	Task Information
DPM_COM0_SMBX	Task Information
DPM_COM0_RMBX	Task Information
TirTimer	Task Information
MARSHALLER	Task Information
T_PNIO_EDD	Task Information General Diagnosis Info Extended Diagnosis Info XMAC Diagnosis Structure
T_PNIO_ACP	Task Information General Diagnosis Info Extended Diagnosis Info
T_PNIO_DCP	Task Information General Diagnosis Info Extended Diagnosis Info
T_PNIO_MGT	Task Information General Diagnosis Info Extended Diagnosis Info
TCP_UDP	Task Information IP Information IP Packet Count TCP_UDP Information
T_RPC	Task Information General Diagnosis Info Extended Diagnosis Info
T_PNIO_CMCTL	Task Information General Diagnostics Extended Diagnostics NRPM (Device NameResolution) results Connection Establishment results
T_PNIO_APCTL	Task Information General Diagnosis Info Extended Diagnosis Info
T_PNIO_APCFG	Task Information General Diagnosis Info Extended Diagnosis Info
SNMP Server	Task Information
Mib Database	Task Information
LLDP-Task	Task Information
Packet Router	Task Information

RX_SYSTEM > Task Information

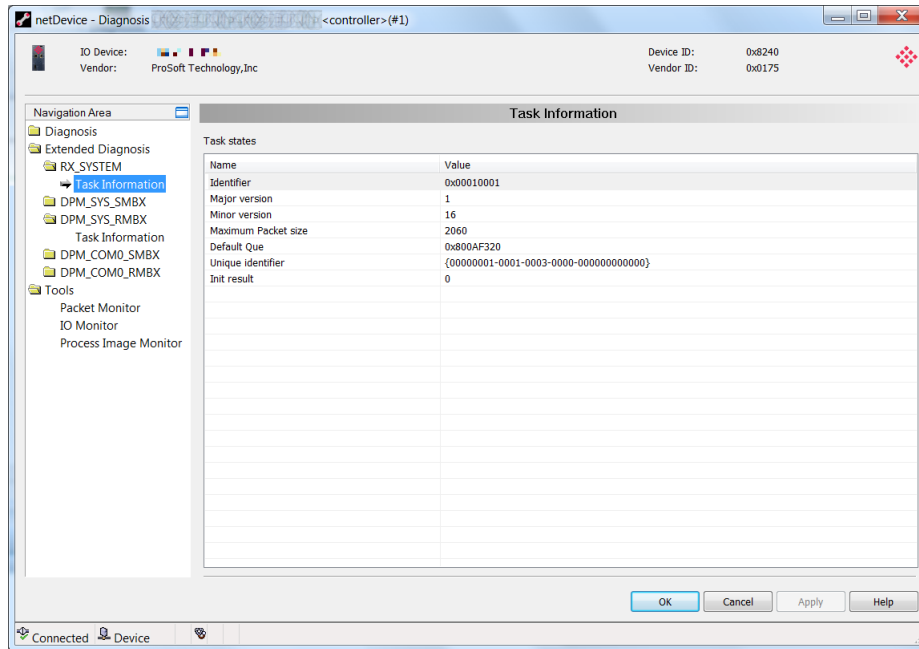

Parameter	Description
Identifier	Identification number of the task.
Major version	Task version, contains all incompatible changes.
Minor version	Task version, contains compatible changes.
Maximum packet size	Maximum packet size that the task sends.
Default queue	Queue handle accessible via DPM by mailbox
Unique Identifier	16 byte indicator used for task identification and its affiliation (e.g., to a stack)
Init result	Error Code, 0 = no error The description of error codes are available in the following sections.

General Diagnosis Information

General Diagnosis Information	
Task states	
Name	Value
Last TLR error code	Operation succeeded.
Last PNIO error code	0x00000000
TLR Error Counter (may count single error seve...	0
PNIO Error Counter (may count single error sev...	0
Active PM Counter	0
Send Packet Error Counter	0
Malloc Error Counter	0
ErrExternal (Received unsupported Requests)	0
ErrInternal (Received unsupported Confirmations)	0
Maximum Pool usage	0
Current Pool usage	0

Parameter	Description
Last TLR error code	Error code of the last internally occurred error.
Last PNIO error code	Error code of the last externally occurred error which has been reported by an I/O device.
TLR Error Counter	Counts the number of occurred TLR error codes.
PNIO Error Counter	Counts the number of occurred PNIO error codes.
Active PM Counter	Counter of the active protocol machines in the task.
Send Packet Error Counter	Counts how often a task sends a packet to another task and this fails.
Malloc Error Counter	Counts how often storage capacity is requested in the operating system and the operating cannot follow this demand.
ErrExternal	Counts how often an unknown request packet was received.
ErrInternal	Counts how often an unknown confirmation packet was received.
Maximum Pool Usage	Counts how many pool elements were used simultaneously (maximum).
Current pool usage	Counts the number of pool elements currently in use.

T. PNIO EDD Extended Diagnosis Information

Extended Diagnosis Information	
Task states	
Name	Value
Cyclic Frames sent	0
Missing cyclic Frames counter (CPM)	0

Parameter	Description
Cyclic Frames sent	Counts cyclical frames that were sent.
Missing Cyclic Frames counter (CPM)	Counts the missing cyclical frames agreed on.

XMAC Diagnosis Structure

XMAC diagnosis structure	
Task states	
Name	Value
FramesTransmittedOk	0
SingleCollisionFrames	0
MultipleCollisionFrames	0
LateCollisions	0
LinkDownDuringTransmission	0
UtxUnderflowDuringTransmission	0
FramesReceivedOk	0
FrameCheckSequenceErrors	0
AlignmentErrors	0
FrameTooLongErrors	0
RuntFramesReceived	0
CollisionFragmentsReceived	0
FramesDroppedDueLowResource	0
FramesDroppedDueUrxOverflow	0

The values of the XMAC diagnosis structure are read every 2 seconds from the XMACs (hardware).

Parameter	Description	Value/Range of Values
FramesTransmittedOK	Number of the correctly received Ethernet frames	0 to 4,294,967,295
SingleCollisionFrames	Number of the frames involved in a collision.	0 to 4,294,967,295
MultipleCollisionFrames	Number of frames involved in several collisions	0 to 4,294,967,295
LateCollisions	Number of clashed frames after at least 512 bits of the frame have been transmitted	0 to 4,294,967,295
LinkDownDuring Transmission	Number of frames sent during a broken connection	0 to 4,294,967,295
UtxUnderflowDuring Transmission	Number of frames sent erroneously because of buffer underflow.	0 to 4,294,967,295
FramesReceivedOK	Number of correctly received frames	0 to 4,294,967,295

FrameCheckSequence Errors	Number of corruptly received frames (FCS check failed)	0 to 4,294,967,295
AlignmentErrors	Number of frames received in which its length is not an even number of bytes	0 to 4,294,967,295
FrameTooLongErrors	Number of frames received in which its length exceeds the maximum permitted frame length	0 to 4,294,967,295
RuntFramesReceived	Number of frames received undamaged with a length of 42 to 63 bytes. (Under run of the minimum permitted frame length)	0 to 4,294,967,295
CollisionFragments Received	Number of frames received corruptly with a length of 42 to 63 bytes. (FCS check failed)	0 to 4,294,967,295
FramesDroppedDueLow Resource	Number of frames lost because of a memory deficiency	0 to 4,294,967,295
FramesDroppedDueUrx Overflow	Number of frames lost because of buffer underflow	0 to 4,294,967,295

T PNIO ACP Extended Diagnosis Information

Extended Diagnosis Information	
Task states	
Name	Value
Received unsupported Frames	0
Active Consumer Protocol Machines	0
Active Provider State Machines	0
Received high priority alarms	0
Received low priority alarms	0

Parameter	Description
Received unsupported frames	Frames which cannot be used by the consumer.
Active Consumer Protocol Machines	Number of state machines supervised by the cyclical communication consumer = receiver (supervises frames of the I/O devices received)
Active Provider State Machines	Number of state machines, the frames transmit to the devices
Received high priority alarms	Number of high priority alarms for PROFINET IO
Received low priority alarms	Number of low priority alarms for PROFINET IO

PNIO_DCP Extending Diagnosis Information

Extended Diagnosis Information	
Task states	
Name	Value
Active Application Timers Counter	0
Erroneous Frames received	0
Ident Request sent Counter	0
Ident Response received Counter	0
DCP Set Requests sentcounter	0
Positiv DCP Set Responses	0
Negativ DCP Set Responses	0
DCP Hello Requests Received	0
Hello reported to NRPM	0

The PNIO_DCP Extended Diagnosis information displays the counter reading of the four state machines from the PROFINET I/O DCP protocol.

- MCR - Multicast Receiver
- UCR - Unicast Receiver
- MCS - Multicast Sender
- UCS - Unicast Sender

Parameter	Description
Active Application Timers Counter	Software timer actually running in the task.
Erroneous Frames received	Counter for erroneous frames received.
Ident Request sent Counter	Counter for Ident Request send Counter
Ident Response received Counter	Counter for Ident Responses received
DCP Set Request sentcounter	Could for DCP Set Request sent
Positive DCP Set Responses	Counter for Positive DCP Set Responses
Negative DCP Set Responses	Counter for Negative DCP Set Responses
DCP Hello Requests Received	Counter for DCP Hello Requests received
Hello reported to NRPM	Counter for Hello reported to the NRPM state machine.

T_PNIO_MGT Extended Diagnosis Information

Extended Diagnosis Information	
Task states	
Name	Value
Ident Requests Sent	0
Ident Responses received (Conflict)	0
Ident Responses received (Forbid)	0
Ident Responses received (Permit)	0
Identify Q Indications received (Multiple)	0
Identify Q Indications received (Forbid)	0
Identify Q Indications received (Permit)	0
NRPM Init Request Counter	0
NRPM Init Confirm Counter	0
NRPM Init Error Counter	0
Identify Q Indications received (Ident ALL)	0

Parameter	Description
Ident Requests Sent	PROFINET I/O specific service
Ident Responses received (Conflict)	Status of the internal status machines in the controller.
Ident Responses received (Forbid)	
Ident Responses received (Permit)	
Identify Q Indications received (Multiple)	Status of the internal status machines in the controller.
Identify Q Indications received (Forbid)	
Identify Q Indications received (Permit)	
NRPM Init Request Counter	Counter for special PROFINET I/O services
NRPM Init Confirmation Counter	Counter for special PROFINET I/O services
NRPM Init Error Counter	Counter for special PROFINET I/O services
Identify Q Indications received (Ident ALL)	Counter for special PROFINET I/O services

TCP_UDP

IP Information

IP Information	
Task states	
Name	Value
Task State	1
Error Count	2
Last Error	0xC0000119
IP Address	0.0.0.0
Net Mask	0.0.0.0
Gateway	0.0.0.0

Parameter	Description
Task State	Actual state of the protocol process: 0 = Task not initialized 1 = Task is running 2 = Task initialized 3 = Initialization
Error Counter	Counter for errors
Last Error	Last error that occurred
IP Address	IP address of the slave device
Netmask	Network mask of the slave device
Gateway	Gateway address of the Slave device

IP Packet Counter

IP Packet Count	
Task states	
Name	Value
Packet Recv TCP	0
Packet Recv UDP	28631
Packet Recv ICMP	0
Packet Recv IP Header Err	0
Packet Recv ARP	8
Packet Recv Unknown	0

Parameter	Description
Packet Recv TCP	Counter for received TCP packets
Packet Recv UDP	Counter received for UDP packets
Packet Recv ICMP	Counter for received ICMP packets
Packet Recv IP Header Err	Counter for received IP packets with errors
Packet Recv ARP	Counter for received ARP packets
Packet Recv Unknown	Counter for received packets of an unknown type

TCP_UDP Information

TCP_UDP Information	
Task states	
Name	Value
Task State	1
Error Count	2
Last Error	0xC0080032

Parameter	Description
Task State	Actual state of the protocol process: 0 = Task not initialized 1 = Task is running 2 = Task initialized 3 = Initialization error
Error Count	Counter for errors
Last Error	Last error that occurred

T_RPC

Extended Diagnosis Information	
Task states	
Name	Value
PINGS sent	0
PINGS received	0
WORKINGS sent	0
WORKINGS received	0
NOCALLs sent	0
NOCALLs received	0
CANCELs sent	0
CANCELs received	0
REJECTs sent	0
REJECTs received	0
Requests sent	0
Requests received	0
Responses sent	0
Responses received	0
Fragments sent	0
Fragments received	0
Active Application Timers	0

The T_RPC Extended Diagnosis Information displays PROFINET I/O specific counters.

T_PNIO_CMCTL

Extended Diagnosis Information	
Task states	
Name	Value
Release Request Counter	0
Received RPC RequestsCounter	0
Sent RPC Requests Counter	0
Module Diff Block Counter	0
Connect Request Counter	0
NRPM Init Request Counter	0
Positive NRPM Init Response Counter	0
Negativ NRPM Init Response Counter	0
Get Device Information counter	0
Read Request counter	0
Positive Read Response Counter	0
Negativ Read Response Counter	0
Write Request counter	0
Positive Write Response Counter	0
Negativ Write Response Counter	0

The T_PNIO_CMCTL Extended Diagnostics Information displays PROFINET I/O specific counters.

T_PNIO_APCTL

Extended Diagnosis Information	
Task states	
Name	Value
Active Application Timers	0
Received Alarms	0
Received Diagnosis Alarms	0
Diagnosisentries read by Application	0
Alarms indicated to Application	0
Counter for packets that could not be ...	0
Flags	0x00000001

Parameter	Description
Active Application Timers	Number of active software timer.
Received Alarms	Alarms read by the application
Received Diagnosis Alarms	
Diagnosis entries read by application	
Alarms indicated by application	
Counter for packets that could not be sent to the application	Counts how often packets are sent from the firmware to the application and then fails
Flags	Cached status data

T_PNIO_APCFG

Extended Diagnosis Information	
Task states	
Name	Value
Overhead for database	0 Byte
Amount of configured IO-Devices	0
Amount of configured IOCRs	0
Amount of configured APIs	0
Amount of configured Modules	0
Amount of configured Submodules	0
Amount of configured SubmoduleDesc...	0
Amount of configured Data Records	0
Amount of active IO-Devices	0
Amount of configured InterfaceSubmo...	1
Amount of configured PortSubmoduleI...	1

The T_PNIO_APCFG Extended Diagnostics Information displays PROFINET I/O specific parameters.

9.3.7 Tools

The *Packet Monitor*, *I/O Monitor*, and *Process Image Monitor* tools are provided for testing and diagnostic functions. Access to the tools requires a connection between ProSoft fdt Configuration Manager and the PNC driver.

Packet Monitor

The *Packet Monitor* is used for testing and diagnostics. Data packets are self-contained blocks of a defined data length. The packets are used to communicate with the firmware and are exchanged between the application (configuration software) and the firmware in the device. Packets can be sent once or cyclically to the connected device controlled by the user and received packets can be displayed.

Data packets include a packet header and the sent data or may be comprised of a packet header and received data. The packet data can be evaluated by the receiver of the packet and contain the sender and receiver address, data length, ID number, status and error messages, and the command or response code.

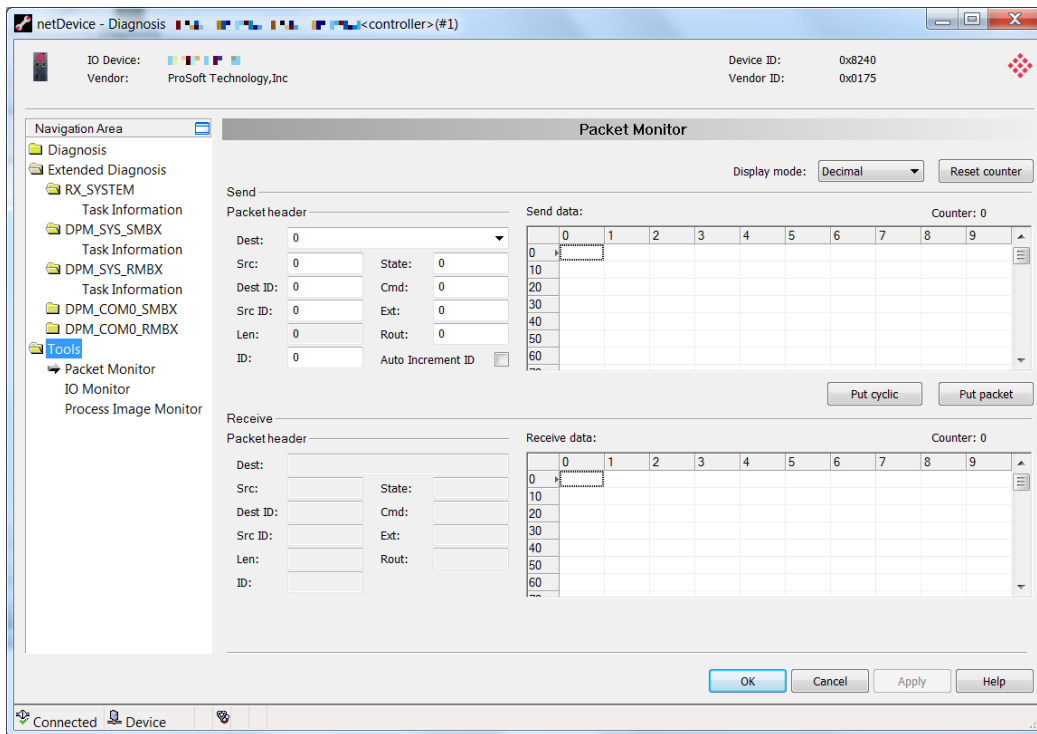

DISPLAY MODE switches the representation of data between decimal and hexadecimal. Use the **RESET** button to reset the packet counter.

Send Packet

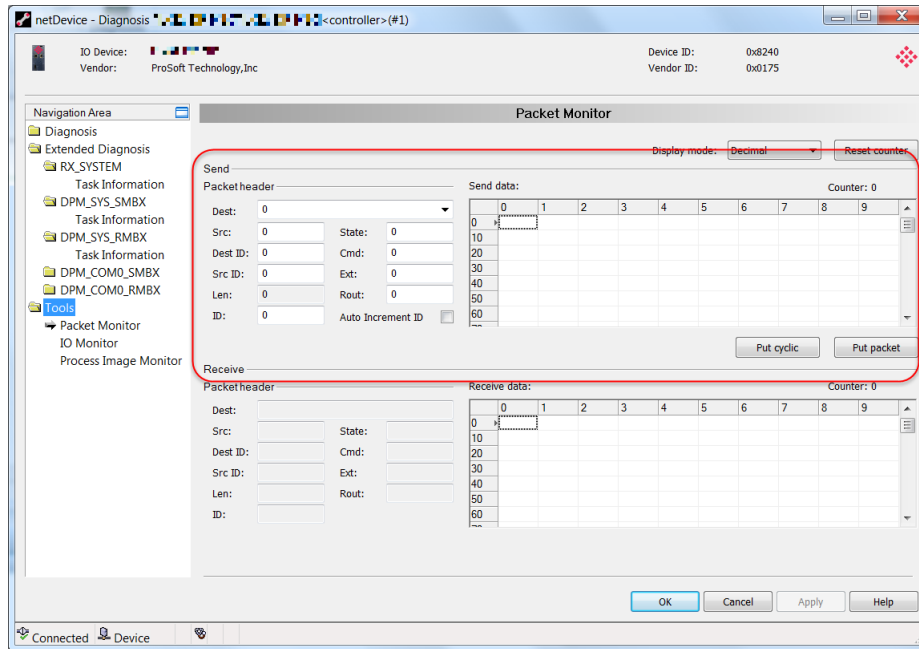

Packet Header

Packet elements of the send packet header are displayed. This information is transmitted from the application (configuration software) to the device.

Parameter	Value	Description
Dest	Destination Queue Handle	Contains the identifier of the receiver for the packet (destination tasks queue of the firmware).
Src	Source Queue Handle	Contains the identifier of the sender of the packet (sending task).
Dest ID	Destination Queue Reference	Contains an identifier for the receiver of unsolicited sent packets from the firmware to the application (configuration software).
Src ID	Source Queue Reference	Contains an identifier of the sender.
Len	Packet Data Length (in bytes)	Length of the send data.
State	Status/Error Code	Transmits status or error codes to the packet sender.
Cmd	Command/Response Code	Command or respond code.
Ext	Extension	Field for extensions.
Rout	Routing Information	Internal value of the firmware.
ID	Packet identification as unique number	Identifies identical data packets among each other.

- 1 Select the the receiver (destination task queue) from the **DEST** drop-down list box.

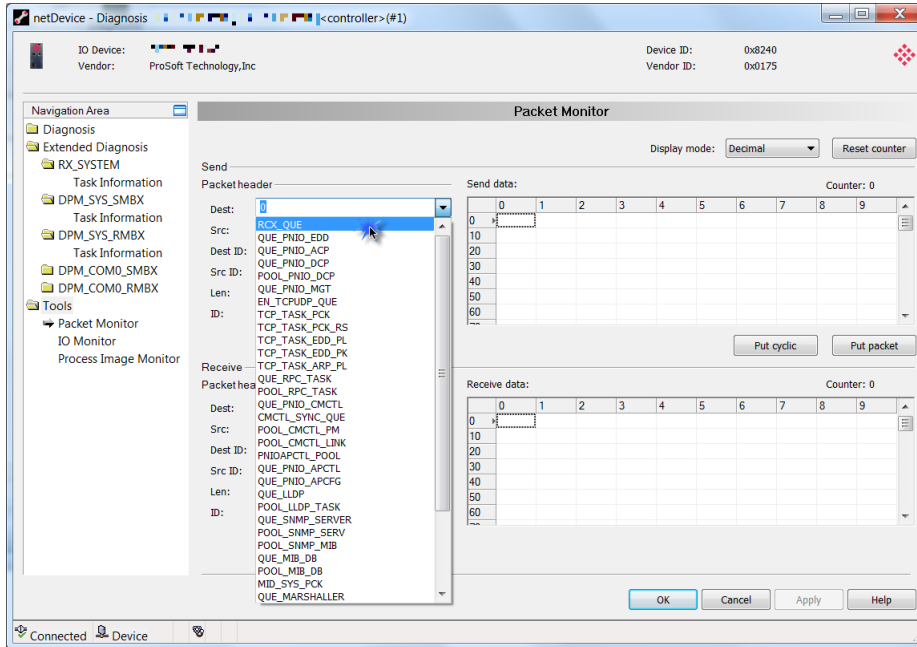

- 2 Enter the command in the *Cmd* field (request).

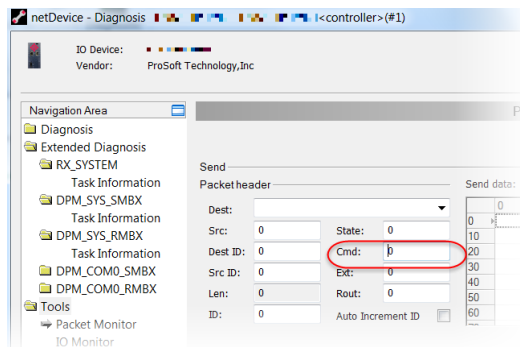

- 3 The **AUTO INCREMENT ID** checkbox specifies that the identifier should be incremented by one for each newly sent packet.

Send Data pane

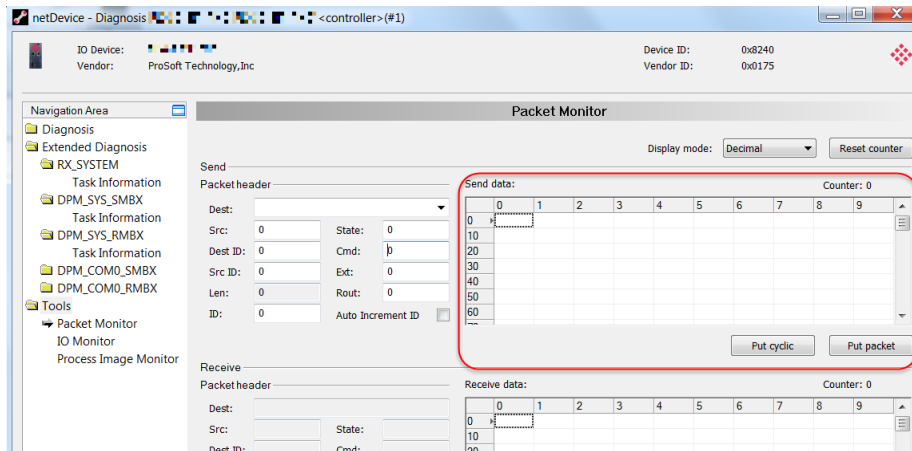

This area allows you to enter the send data of the packet that is transmitted from the application (configuration software) to the mailbox of the device. The description of the transmitted data depends on the command or response code.

- The **PUT CYCLIC** button specifies that the packet should be sent cyclic.
- The **PUT PACKET** button specifies that the packet should be sent once.

Receive Packet

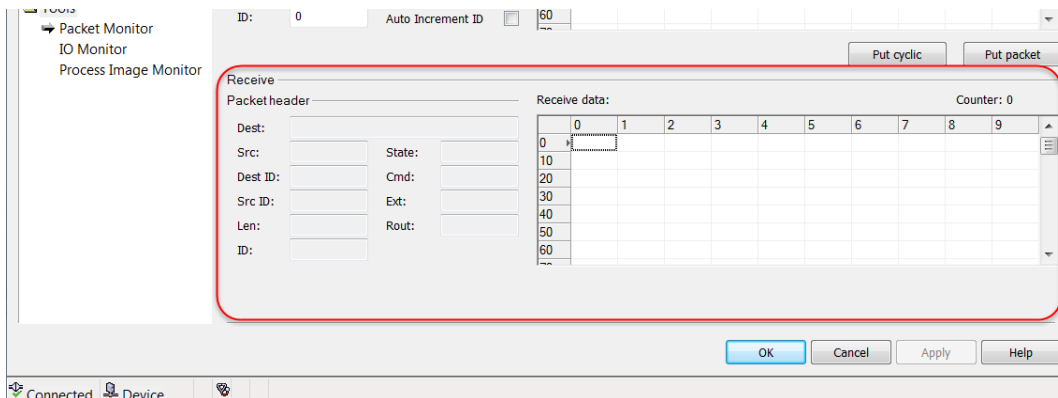

Packet Header

Packet elements of the receive packet header are displayed. This information is transmitted from the device to the application (configuration software).

Parameter	Value	Description
Dest	Destination Queue Handle	Contains the identifier of the receiver of the packet (destination task queue of the firmware).
Src	Source Queue Handle	Contains the identifier of the sender of the packet (sending tasking)
Dest ID	Destination Queue Reference	Contains an identifier for the receiver on unsolicited sent packets from the firmware to the application (configuration software).
Src ID	Source Queue Reference	Contains an identifier of the sender
Len	Packet Data Length (in bytes)	Length of the send respectively receive data.
ID	Packet Identification as Unique Number	Identifies identical data packets among each other.
State	Status/Error Code	Transmits status or error codes to the packet sender.
Cmd	Command/Response Code	Command or response code.
Ext	Extension	Field for extensions.
Rout	Routing information	Internal values of the firmware.

Receive Data pane

Displays the receiving data of the packet transmitted back from the device to the application (configuration software).

I/O Monitor

The *I/O Monitor* is used for testing and diagnostic purposes. It provides a view of the process data image (in bytes) and allows the change of data easily.

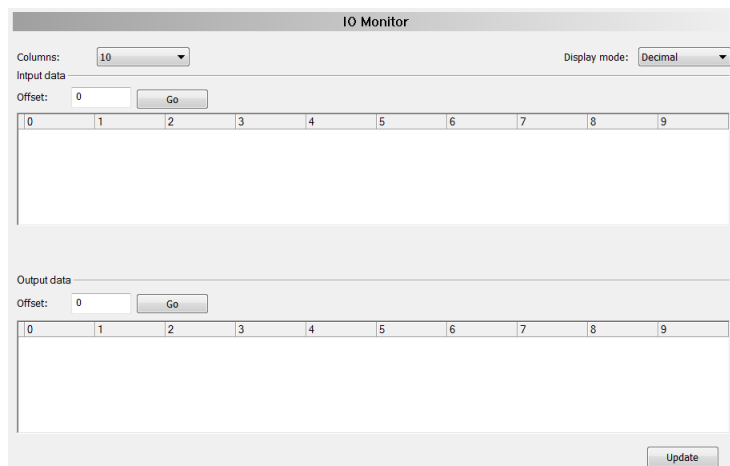

Warning: Only change and write output data if you know that it will not cause plant disturbances. All output data written by the I/O Monitor are transmitted at the bus and have an effect on subordinate drives, IO, etc.

- The **COLUMNS** drop-down list changes the number of columns.
- The **DISPLAY MODE** drop-down list allows you to switch the representation of the input and output data between decimal and hexadecimal.
- The **OFFSET / GO** parameters move the indication of the data to the entered offset value.

Enter the output value and click the **UPDATE** button.

Process Image Monitor

This monitor lists devices connected to the PNC controller, as well as configured modules or input or output signals of the devices. This allows you to view the fieldbus structure and the data structure of the device's input and output data transmitted on the bus. Signal data provided to the OPC server is also displayed here.

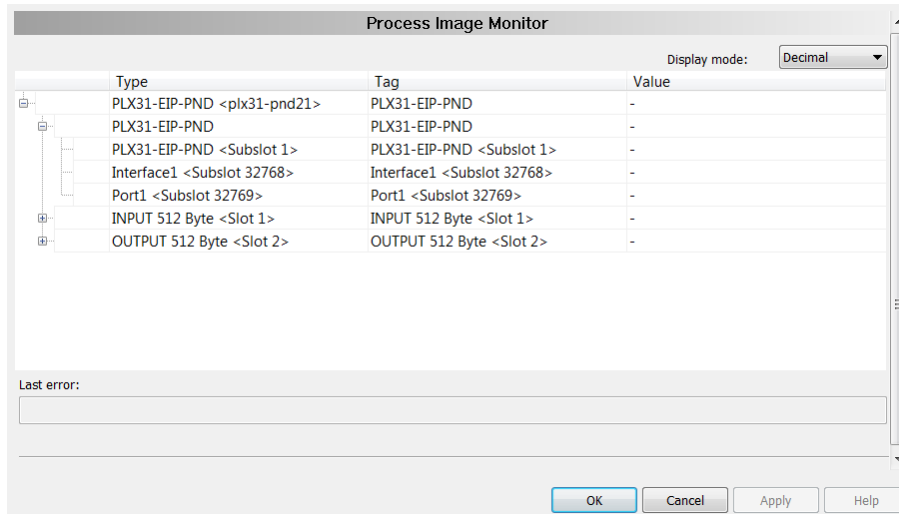

Parameter	Description
Display Mode	Allows you to display values in the Value column in decimal or hexadecimal mode.
	A tree structure is used to display the structure of the devices: Devices(1) Modules (2) Input Data (3) Output Data (4)
	Shown when the input and output data are not completely read and analyzed.
	Displayed when input and output data are not valid.
	Displayed when input and output data are valid.
Type	Device labeling in the hardware. Describes the module or input or output signals configured for the device.
Tag	Device name provided by the hardware (not changeable within PCB for PROFINET configuration software) or symbolic name for the modules configured for the device for input and output signals (changeable on the Configuration > Process Data page)
Value	Displays the valid input and output data values
Last Error	Last error to occur.

9.3.8 MBTCP Status Data in Upper Memory

The MBTCP driver has an associated status data area located in the PLX82-MBTCP-PNC's upper memory. The Data Map functionality of the PLX82-MBTCP-PNC can be used to map this data into the normal user data range of the PLX82-MBTCP-PNC's database.

Note that all the status values are initialized to zero (0) at power-up, cold boot and warm boot.

MBTCP Server Status Data

The following table lists the addresses in upper memory where the PLX82-MBTCP-PNC stores status data for MBTCP servers:

Server Port	Address Range
2000	11000 through 11009
502	11010 through 11019
2001	11020 through 11029

The content of each server's status data area is structured the same. The following table describes the content of each register in the status data area:

Offset	Description
0	Number of Command Requests
1	Number of Command Responses
2	Number of Command Errors
3	Number of Requests
4	Number of Responses
5	Number of Errors Sent
6	Number of Errors Received
7	Configuration Error Word
8	Current Error Code
9	Last Error Code

MBTCP Client Status Data

The following table lists the addresses in upper memory where the PLX82-MBTCP-PNC stores status data for each MBTCP Client:

Client	Address Range
0	12000 through 12025
1	12026 through 12051
2	12052 through 12077
.	.
8	12208 through 12233
9	12234 through 12259

The content of each Client’s status data area is structured the same. The following table describes the content of each register in the status data area:

Offset	Description
0	Command Request Count (total Client commands sent)
1	Command Response Count (total command responses received)
2	Command Error Count
3	Number of Request Packets
4	Number of Response Packets
5	Errors Sent
6	Errors Received
7	Reserved
8	Current Error
9	Last Error

- Offsets 8 and 9 contain information about the most recent communication errors.
- The Current Error (offset 8) has a non-zero value if the currently executing client command experiences an error.
- The Last Error (offset 9) stores the most recent non-zero value error code that was reported by the client the last time it experienced an error. Note that this value is protected. This register holds the last error value until you clear the memory by a restart, reset, cold-boot, or warm-boot operation. Therefore, any value you see here may be from an error that occurred at any time since the PLX82-MBTCP-PNC was last restarted and may not indicate a current or recent error.

MBTCP Client Command List Error Data

The PLX82-MBTCP-PNC stores a status/error code in upper memory for each command in each MBTCP client's command list. The following table lists the addresses in upper memory where the PLX82-MBTCP-PNC stores the command list error data for each MBTCP Client:

Client	Address Range
0	15510 to 15525
1	15536 to 15551
2	15562 to 15577
.	.
.	.
8	15718 to 15733
9	15744 to 15759

The first word in each client's command list error data area contains the status/error code for the first command in the client's Command List. Each successive word in the Command Error List is associated with the next command in the client Command List. Therefore, the number of valid error values depends on on the number of commands defined.

The structure of the command list error data area (which is the same for all Clients) is displayed in the following table:

Offset	Description
0	Command #1 Error Code
1	Command #2 Error Code
2	Command #3 Error Code
3	Command #4 Error Code
.	.
.	.
13	Command #14 Error Code
14	Command #15 Error Code
15	Command #16 Error Code

A non-zero error code for a command indicates an error.

9.3.9 MBTCP Error Codes

Standard Modbus Exception Code Errors

These error codes are generated or returned on both the Controller and slave ports. These codes are the standard Modbus errors.

Code	Description
1	Illegal Function
2	Illegal Data Address
3	Illegal Data Value
4	Failure in Associated Device
5	Acknowledge
6	Busy, Rejected Message

MBTCP Client Specific Errors

These error codes are specific to the MBTCP client.

Code	Description
-33	Failed to connect to server specified in command
-35	Wrong message length in the response
-36	MBTCP command response timeout (same as -11)
-37	TCP/IP connection ended before session finished

MBTCP Communication Error Codes

The gateway detects these command-specific error codes during initial configuration at gateway power-up or reset and are stored in the *Command Error List* memory region.

Code	Description
-2	Timeout while transmitting message
-11	Timeout waiting for response after request (same as -36)
253	Incorrect slave/server address in response
254	Incorrect function code in response
255	Invalid CRC/LRC value in response

MBTCP Command List Error Codes

The PLX82-MBTCP-PNC detects these command-specific error codes during initial command list loading at PLX82-MBTCP-PNC power-up or reset and are stored in the *Command Error List* memory region.

Code	Description
-40	Too few parameters
-41	Invalid enable code
-42	Internal address > maximum address
-43	Invalid node address (<0 or >255)
-44	Count parameter set to 0
-45	Invalid function code
-46	Invalid swap code

9.3.10 PNC Status Data in Upper Memory

The PNC driver has an associated status data area located in the PLX82-MBTCP-PNC's upper memory. The *Data Map* functionality can be used to map this data into the normal user data range of the PLX82-MBTCP-PNC's database. All the status values are initialized to zero (0) at power-up, cold boot and during warm boot.

PNC Status	Address Range	Description
Number of Input Messages	13000	Total number of write messages to PLC
Internal DPM Input Status Count	13001	Total number of write error messages
Internal DPM Input Status	13002	Error write message status (See tables below)
Number of Output Messages	13004	Total number of read messages from PLC
Internal DPM Output Status Count	13005	Total number of read error messages
Internal DPM Output Status	13006	Error read message status (See tables below)
Connection Count	13008	Total number of Connections
Communication Status	13009	Connection Status: 0 (Disconnected) or 1 (Connected)
Device Status (36)	13010	36 PN Device Status: 0 or an error number (See tables below)
Input IOPS Information	13082	Input State information (See tables below)
Output IOPS Information	13348 (N/A)	Output State information

Internal DPM Input and Output Status Codes

Status Code	Description
0x00000000	No error
0x800B0001	Driver was not correctly initialized during startup or driver is already closed
0x800B0002	Initialization state error. Hardware does not show correct or expected states and information after a reset or bootup
0x800B0003	Driver read state error
0x800B0004	The function is in use by another program instance or application
0x800B0005	General error during download (e.g. bootloader could not be downloaded or started)
0x800B0006	Wrong driver version
0x800B0030	The driver is not loaded/running. Failed to open or start the driver.
0x800B0031	Failed to initialize the driver
0x800B0032	Channel not initialized
0x800B0033	Function call into the driver failed
0x800B0034	Driver was not opened by calling Driver Open function
0x800C0010	Dual port memory not accessible (e.g. board not found, wrong dual port memory content)
0x800C0011	The device is not ready. The system device or communication channel is not working
0x800C0012	The device is not running. The communication channel is not configured
0x800C0013	Watchdog test failed
0x800C0015	Error in handshake flags

Status Code	Description
0x800C0016	Send mailbox is full
0x800C0017	Send packet timeout
0x800C0018	Receive packet timeout
0x800C0019	No packet available
0x800C001A	Mailbox is too short for the given packet.
0x800C0020	Reset command timeout. The device was not reaching READY state, in the given reset timeout, after the application has initiated a reset.
0x800C0021	Communication flag not set. The Fieldbus protocol stack has no communication with the Fieldbus devices. Either the cable is disconnected or no other device is connected to the wire.
0x800C0022	I/O data exchange failed
0x800C0023	I/O data exchange timeout
0x800C0024	Unknown I/O data exchange mode
0x800C0025	Device function failed
0x800C0026	Memory size differs from the configuration
0x800C0027	Unknown state mode
0x800C0028	The device is accessed either by another application or another instance. - Driver/device can't be unloaded, open connection to the system device or communication channels still active - Open channel can't be executed because it is currently used by another application
0x800C0029	Failed to lock the communication channels configuration within the given time.
0x800C002A	Failed to unlock the communication channel configuration within the given time.
0x800C002B	Wait time expires. The device has not acknowledged the new status in time.
0x800C002C	Wait time expires. The function was not able to clear flag
0x800C002D	Timeout during device / channel initialization
0x800C002E	Wait time expires
0x800C002F	Wait time expires. The device has not acknowledged the new status in time.
0x800C0040	Firmware module download and start failed because a module is already running
0x800C0041	Firmware module download was skipped because the module already exists
0x800C0050	A number of configured DMA buffers insufficient (at least 8 buffers are expected)
0x800C0051	DMA buffers size too small
0x800C0052	DMA buffers size too big
0x800C0053	DMA buffer alignment failed
0x800C0054	I/O process data exchange not allowed
0x800C0055	I/O process data area index not supported
0x800C0056	Failed to set DMA transfer to "ON" within the given wait time
0x800C0057	Failed to set DMA transfer to "OFF" within the given wait time
0x800C0058	The device is in the invalid mode
0x800C0059	Wait time expired during. Device does not signal the expected synchronization handshake flag state

Device Status Bit Map

Bit Position	Description
13 to 31	Unused, set to zero
12	Inactive Module present
11	ModuleDiffBlock present
10	Packet too small
9	Diagnosis buffer overwritten
8	Diagnosis buffer overflow
7	Diagnosis disappeared
6	Diagnosis data present for IO-Device
5	IO-Device deactivated
4	IO-Device parameter fault
3	IO-Device invalid response
2	IO-Device configuration fault
1	IO-Device not ready
0	IO-Device does not exist

Input IOPS Information

Bit Position	Description
0x00	Bad Subslot
0x20	Bad Slot
0x40	Bad Device Submodule / module

10 Reference

10.1 Specifications

10.1.1 Hardware Specifications

Specification	Description
Power supply	24 Vdc nominal 10 Vdc to 36 Vdc allowed Positive, Negative, GND terminals
Current load	24 Vdc nominal @ 400 mA 10 to 36 Vdc @ 610 mA maximum
Operating temperature	0°C to 50°C (32°F to 122°F)
Storage temperature	-10°C to 70°C (-14°F to 158°F)
Relative humidity	5% to 95% RH with no condensation
Shock	IEC60068-2-27; 15G @ 11ms, 3-axis (Operational) IEC60068-2-27; 30G @ 18ms, 3-axis (Non-operational)
Vibration	IEC 60068-2-27; 5G @ 10 Hz to 150 Hz
Dimensions (H x W x D)	5.52 x 2.06 x 4.37 in 14.01 x 5.24 x 11.09 cm
LED indicators	Configuration (CFG) and Error (ERR) status Power (PWR) and Hardware Fault (FLT) Network Status (NS) EtherNet/IP™ Class I or Class III Connection Status (EtherNet/IP only) Module Status (MS) Module Configuration Status (EtherNet/IP only) Ethernet communication port Link/Activity and 100mbit PROFINET - SYS, SF, BF
Ethernet Port	10/100Mbit RJ45 connector Electrical isolation 1500 Drums at 50 Hz to 60 Hz for 60 seconds, applied as specified in section 5.3.2 of IEEE 60950: 1991 Ethernet Broadcast Storm Resiliency = less than or equal to 5000 [ARM] frames-per-second and less than or equal to 5 minutes duration
Shipped with unit	2.5 mm screwdriver, J180 power connector

10.1.2 Modbus TCP/IP (MBTCP) Specifications

Specification	Description
Supported Modbus Function Codes	1: Read Coil Status 2: Read Input Status 3: Read Holding Registers 4: Read Input Registers 5: Force (Write) Single Coil 6: Preset (Write) Single Holding Register 15: Force (Write) Multiple Coils 16: Preset (Write) Multiple Holding Registers 22: Mask Write Holding Register (Slave only) 23: Read/Write Holding Registers (Slave only)
Supported Clients	10
Supported Servers	
MBAP	5
Encapsulated	5
Command List	Up to 160 fully-configurable client commands
Status Data	Error codes reported individually for each command
Command List Polling	Each command can be individually enabled or disabled; write-only-on-data change is available

10.1.3 PROFINET (PNC) Specifications

Specification	Description
Driver Type	Class 1 RTC, Class 1 RTA
PROFINET I/O Data	3840 bytes IN, 3840 bytes OUT
Exchange Types	Cyclic Real Time (RT) and Acyclic Data
PROFINET Devices	Max: 36 Max data per device: 2440 bytes IN/OUT

10.2 Performance

The minimum update rate is 8ms, with the driver supporting the following:

Cycle Time

The cycle time, whether communicating with one device or 20 should be no greater than 5ms. Cycle time is the time it takes to copy MBTCP data to the PROFINET data and the PROFINET data to the MBTCP data.

Example:

MBTCP

- Connections: 1 @ 5ms RPI
- Input: 496 bytes
- Output: 496 bytes

PROFINET

- PROFINET Update: 8ms
- Number of Devices: 1
- Input: 496 bytes
- Output: 496 bytes

11 Support, Service & Warranty

11.1 Contacting Technical Support

ProSoft Technology, Inc. is committed to providing the most efficient and effective support possible. Before calling, please gather the following information to assist in expediting this process:

- 1 Product Version Number
- 2 System architecture
- 3 Network details

If the issue is hardware related, we will also need information regarding:

- 1 Module configuration and associated ladder files, if any
- 2 Module operation and any unusual behavior
- 3 Configuration/Debug status information
- 4 LED patterns
- 5 Details about the interfaced serial, Ethernet or Fieldbus devices

North America (Corporate Location) Phone: +1 661-716-5100 ps.prosofttechnology@belden.com Languages spoken: English, Spanish REGIONAL TECH SUPPORT ps.support@belden.com	Europe / Middle East / Africa Regional Office Phone: +33.(0)5.34.36.87.20 ps.europe@belden.com Languages spoken: English, French, Hindi, Italian REGIONAL TECH SUPPORT ps.support.emea@belden.com
Latin America Regional Office Phone: +52.222.264.1814 ps.latinam@belden.com Languages spoken: English, Spanish, Portuguese REGIONAL TECH SUPPORT ps.support.la@belden.com	Asia Pacific Regional Office Phone: +60.3.2247.1898 ps.asiapc@belden.com Languages spoken: Bahasa, Chinese, English, Hindi, Japanese, Korean, Malay REGIONAL TECH SUPPORT ps.support.ap@belden.com

For additional ProSoft Technology contacts in your area, please visit:
www.prosoft-technology.com/About-Us/Contact-Us

11.2 Warranty Information

For complete details regarding ProSoft Technology’s legal terms and conditions, please see:

www.prosoft-technology.com/ProSoft-Technology-Legal-Terms-and-Conditions

For Return Material Authorization information, please see:

www.prosoft-technology.com/RMA